

SUPU 速普

轨装接线端子选型手册
RAIL-MOUNTED TERMINAL BLOCK



SUPU 速普

PCB连接器及端子选型手册
PCB CONNECTORS AND TERMINAL BLOCKS



SUPU 速普

工业开关选型手册
INDUSTRIAL SWITCH



SUPU 速普

重载连接器选型手册
HEAVY DUTY CONNECTOR



SUPU 速普

接口模块选型手册
INTERFACE MODULE



SUPU 速普

圆形连接器选型手册
CIRCULAR CONNECTOR BLOCK



SUPU 速普

定制部件选型手册
Customized Parts

轨装接线端子选型手册

RAIL-MOUNTED TERMINAL BLOCK V2.2 I

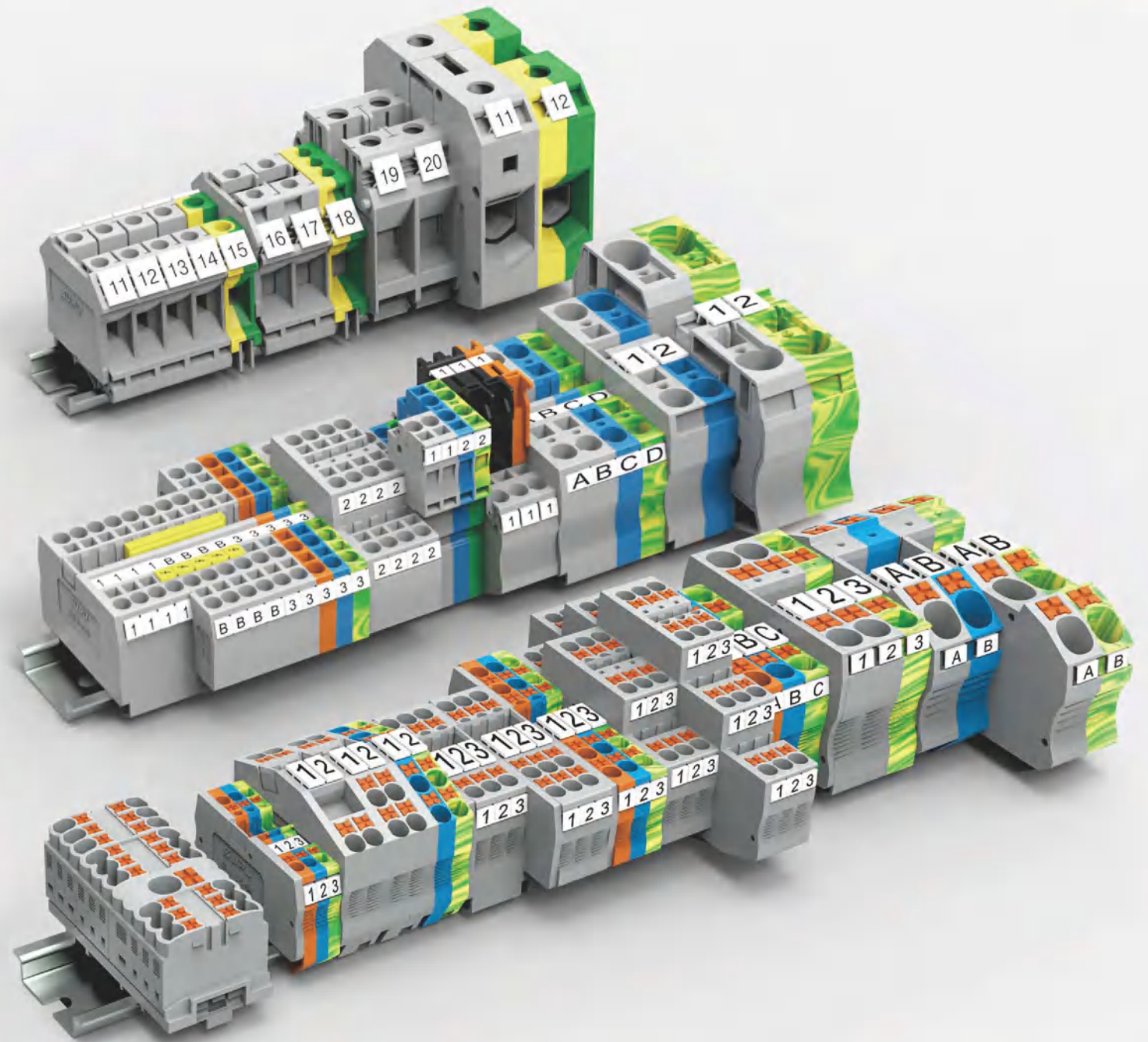

SUPU 速普

宁波速普电子有限公司
NINGBO SUPU ELECTRONICS CO.,LTD.

地址 | 中国浙江省慈溪市坎墩街道兴镇街625号
Add | No.625,Xingzhen Street,Kandun,Cixi City,Zhejiang,China
P.C. | 315303
Service Hotline | 400-626-6336
Tel | 0574-63288158
Fax | 0574-63288170
E-mail | askme@supu.cn
Http | www.supu.com.cn



V2.2 I

轨装接线端子选型手册
RAIL-MOUNTED TERMINAL BLOCK



宁波速普电子成立于1999年，现有电连接器、工业开关、电子产品、定制化产品四大业务版块，是一家集研发、生产、销售、服务于一体的电气产业全球优秀供应商。

速普产品包括轨装接线端子、PCB连接器、工业开关、圆形连接器、重载连接器、接口模块等。公司产品已通过CQC、UL、VDE、TUV、CE、ROHS、REACH等多项认证。公司已通过ISO9001、ISO14001、ISO/TS22163和IATF16949等管理体系认证。

速普产品广泛应用于电梯、电力、轨道交通、工业自动化、新能源、照明、船舶、仪器仪表、机械设备等领域。自公司创立以来，秉承产品创新与科技前瞻的精神，建立了先进的技术研发中心，已获得国家高新技术企业、国家专精特新小巨人企业、宁波工程技术中心等多项荣誉。

在提供标准产品外，同时为客户带去定制化产品解决方案，有效满足客户个性化需求。速普建立了完善的全球销售网络，产品畅销中国、俄罗斯、德国、西班牙、美国、巴西、日本等100多个国家和地区。

Ningbo Supu Electronics Co., Ltd. was established in 1999, which has been a collection of R&D, production, sales, service in one of the world's outstanding suppliers of electrical industry, with four business sections: electrical connector, industrial switch, electronic products, and customized components.

Supu products include Rail-mounted terminals, PCB connectors, Industrial switches, Circular connectors, Heavy-duty connectors, Interface modules, etc. which have passed CQC, UL, VDE, TUV, CE, ROHS, REACH and other certifications. The company has passed ISO9001, ISO14001, ISO/TS22163 and IATF16949 management system certification.

Supu products are widely used in elevator, electric power, rail transit, industrial automation, new energy, lighting, ships, instruments, mechanical equipment and other fields. Since its establishment, adhering to the spirit of product innovation and technological foresight, the company has established an advanced technology research and development center, which has won many honors such as National High-tech Enterprise, National Specialized and New Small Giant Enterprise, Ningbo Engineering Technology Center, etc.

In addition to providing standard products, Supu also bring customized product solutions to effectively meet customers' personalized needs. Supu has established a perfect global sales network, and its products sell well in more than 100 countries and regions such as China, Russia, Germany, Spain, the United States, Brazil, Japan, etc.

使命 Mission

追求全体员工物质和精神两方面的幸福，提升企业价值，
为人类和社会进步与发展做出贡献
Pursuit happiness of all staff in material & spiritual,
promote the enterprise value, contribute to the progress
& development for human & society



愿景 Corporation Vision

成为全球电气产业经营典范
To be the model of the global electric industry



核心价值观 Core Values

勤奋、创新、内求、利他
Diligence, Innovative, Self-seeking, Altruism



质量方针 Quality Policy

追求全程精益品质 持续改进 超越顾客期望 打造行业品牌
To pursuit full lean quality Continuous improvement Exceed
customers expectations Build industry brand

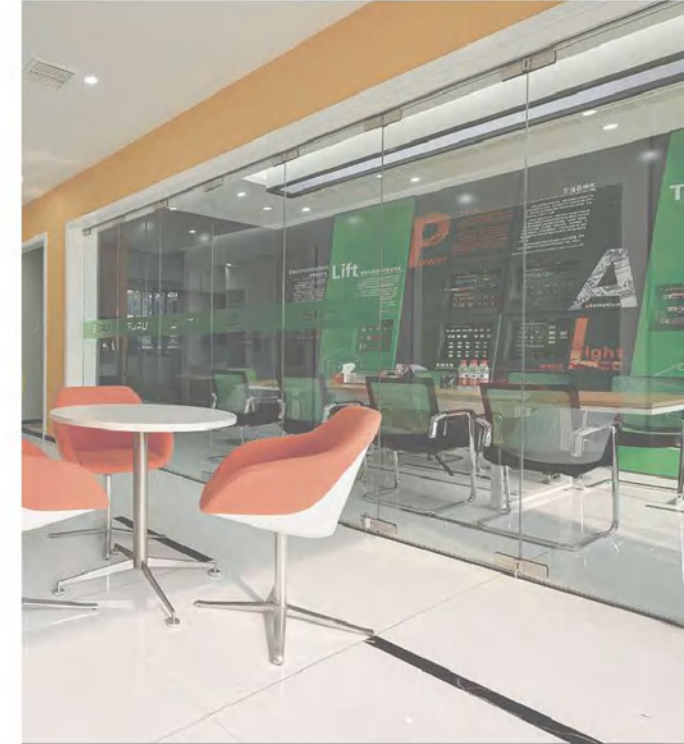

2022新启航 New sail in 2022

开启新征程，共创新辉煌
New journey, New success.
——系统性目标管理，数字化高效运营，打造坚实经营体质
—— Systematic target management,
Digital and efficient operation,
To create a solid management constitution.

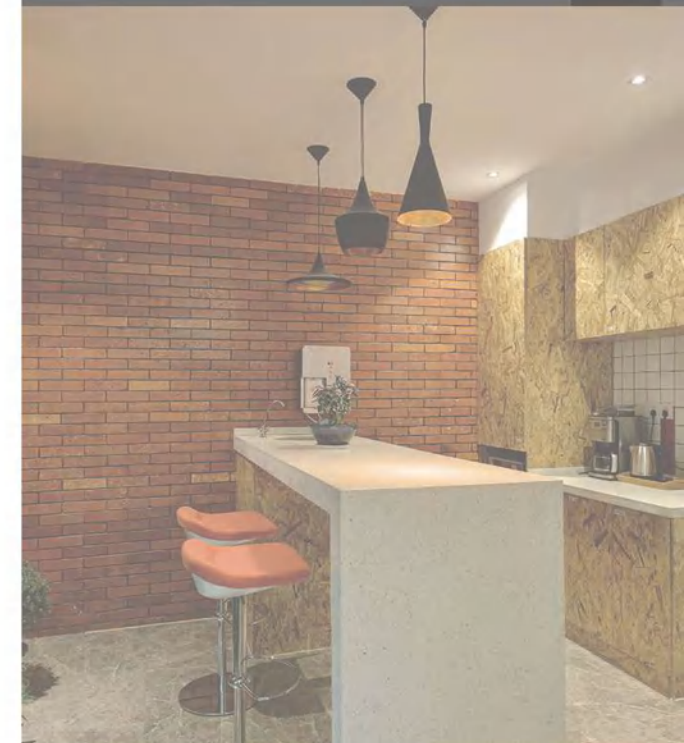

TP系列弹簧接线端子 TP Rail-mounted Terminal Blocks With Spring-cage Clamp

P10-P12 一进一出接线端子 1-1 Feed Through Terminal Block	
P12-P14 一进两出接线端子 1-2 Feed Through Terminal Block	
P15-P16 两进两出接线端子 2-2 Feed Through Terminal Block	
P17-P19 一进一出接地端子 1-1 Through Ground Terminal Block	
P19-P21 一进两出接地端子 1-2 Through Ground Terminal Block	
P22-P23 两进两出接地端子 2-2 Through Ground Terminal Block	
P24-P26 2.5mm² 斜面 Angled	
P27-P29 双层接线端子 Double Level Terminal Block	
P30 双层接地端子 Double Level Ground Terminal Block	
P31-P32 斜面双层八线 Double level angled type 8-wire	
P33-P35 2.5mm² 三层接线端子 Triple Level Terminal Block	

P35-P36 2.5mm² 四层斜面接线端子 Quadruple level angled type terminal block	
P37-P39 2.5mm² 三层接地端子 Triple Level Ground Terminal Block	
P40-P41 针脚式接线端子 Pin type wiring terminal blocks	
P42 一进一出直插式微型 1-1 Push-in mini-type	
P43-P44 功能型接线端子 Functional terminal blocks	
P45-P46 TPIO 系列 TPIO Series	
P47-P50 2.5mm² 直插式配电块 Push-in Type Power Distribution Block	

TAPO 大电流系列 TAPO High Current Series











P51-P53 大电流系列 High Current Series	
P54 等电位分线插头 Power distribution plug	

TC系列弹簧接线端子 TC Rail-mounted Terminal Blocks With Spring-cage Clamp

P57-P59 一进一出接线端子 1-1 Feed Through Terminal Block	
--------------------------------------------------------	--



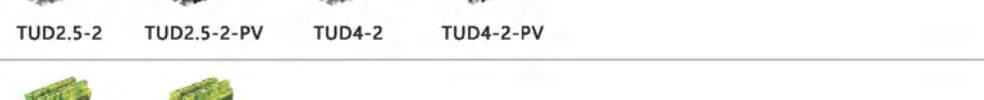









P60-P62 一进一出接地端子 1-1 Feed Through Ground Terminal Block	
	TC1.5-2-PE TC2.5-2-PE TC4-2-PE TC6-2-PE TC10-2-PE TC16-2-PE TC35-2-PE
P63-P64 一进两出接线端子 1-2 Feed Through Terminal Block	
	TC1.5-3 TC2.5-3 TC4-3 TC6-3 TC10-3
P65-P66 一进两出接地端子 1-2 Feed Through Ground Terminal Block	
	TC1.5-3-PE TC2.5-3-PE TC4-3-PE TC6-3-PE TC10-3-PE
P67-P68 两进两出接线端子 2-2 Feed Through Terminal Block	
	TC1.5-4 TC2.5-4 TC4-4
P69-P70 两进两出接地端子 2-2 Feed Through Ground Terminal Block	
	TC1.5-4-PE TC2.5-4-PE TC4-4-PE
P71-P72 两进两出分断式接线端子 With Interrupted Power Rail 2-2 Feed Through Terminal Block	
	TC1.5-2X2 TC2.5-2X2 TC4-2X2
P73-P74 双层接线端子 Double Level Terminal Block	
	TCD1.5-2 TCD1.5-2-PV TCD2.5-2 TCD2.5-2-PV
P75 双层等电位接地端子 Double Level With Equipotential Bonding Ground Terminal Block	
	TCD1.5-2-PE TCD2.5-2-PE
P76 4mm² 带保险管接线端子 Terminal Block With Protective Tube	
	TC4-FUSE-BK TC4-FUSELED24-BK TC4-SPLIT
P77-P78 2.5mm² 插拔接线端子 Plug-in Terminal Block	
	TC2.5-2-1 TCD2.5-2-1 TCD2.5-2-1-PV
P78-P79 2.5mm² 插拔接地端子 Ground Plug-in Terminal Block	
	TC2.5-2-1-PE TCD2.5-2-1-PE
P80 2.5mm² 插头 Plug	
	TCP2.5-1 TCPB2.5-1 TCPDB2.5-1



TU系列螺钉接线端子 TU Rail-mounted Terminal Blocks With Screw Clamp

P81-P87 一进一出接线端子 1-1 Feed Through Terminal Block	
	TU2.5-2 TU4-2 TU6-2 TU10-2 TU16-2 TU35-2 TU50-2
	
	TU70-2 TU95-2 TU150-2 TU240-2
P87-P88 一进两出接线端子 1-2 Feed Through Terminal Block	
	TU2.5-3 TU4-3
P88 两进两出接线端子 2-2 Feed Through Terminal Block	
	TU2.5-4 TU4-4
P89-P92 一进一出接地端子 1-1 Feed Through Ground Terminal Block	
	TU2.5-2-PE TU4-2-PE TU6-2-PE TU10-2-PE TU16-2-PE TU35-2-PE TU50-2-PE TU95-2-PE
P92 一进两出接地端子 1-2 Feed Through Ground Terminal Block	
	TU2.5-3-PE TU4-3-PE
P93 两进两出接地端子 2-2 Feed Through Ground Terminal Block	
	TU2.5-4-PE TU4-4-PE
P94-P95 双层接线端子 Double Level Terminal Block	
	TUD2.5-2 TUD2.5-2-PV TUD4-2 TUD4-2-PV
P96 双层接地端子 Double Level Ground Terminal Block	
	TUD2.5-2-PE TUD4-2-PE
P97 带保险管接线端子 Terminal block with protective tube	
	TU4-HESI TU4-HESI-LED







TA系列弹簧接线端子 TA Rail-mounted Terminal Blocks With Spring-cage Clamp

P99-P103 一进一出接线端子 1-1 Feed Through Terminal Block	
	215921 225921 204921 206921 210921 216921

P104-P106 一进一出接地端子 1-1 Feed Through Ground Terminal Block		215927	225927	204927	206927	210927	216927
P107-P108 一进一出接线端子 (侧面标记) 1-1 Feed Through Terminal Block (Side Marking)		206911	210911	216911			
P109-P110 一进一出接地端子 (侧面标记) 1-1 Feed Through Ground Terminal Block (Side Marking)		206917	210917	216917			
P101-P112 一进一出侧面接线端子 1-1 Feed Through Terminal Block of Side-entry		225915	204901	206901	210901	216901	
P113-P114 一进一出侧面接地端子 1-1 Feed Through Ground Terminal Block of Side-entry		225917	204907	206907	210907	216907	
P115-P117 一进两出接线端子 1-2 Feed Through Terminal Block		215951	225951	204951	206951	210951	216951
P118-P120 一进两出接地端子 1-2 Feed Through Ground Terminal Block		215957	225957	204957	206957	210957	216957
P121-P122 两进两出接线端子 2-2 Feed Through Terminal Block		215931	225931	204931	215901	225901	
P123-P124 两进两出接地端子 2-2 Feed Through Ground Terminal Block		215947	225947	204947			
P125-P127 两进两出分断式接线端子 2-2 Feed Through Terminal Block With Interrupted Power Rail		215936	225936	204936	215903	225903	225908
P128-P129 一进两出斜面接线端子 1-2 Feed Through Angled Type Terminal Block		225961	204961	225965			
P130 一进两出斜面接地端子 1-2 Feed Through Ground Angled Type Terminal Block		225964	204964				

P131-P134 一针一线插拔式端子 1-1 Feed Through Pluggable Terminal Block		2150-1201	225981	2150-1401	2150-1207	225987	2150-1407
P135 插头 Plug		2150-101					

UK系列螺钉接线端子 UK Rail-mounted Terminal Blocks With Screw Clamp

P137-P140 UK接线端子 UK Terminal Block		301901	302901	303901	305901	306901	310901	316901	335901	350901
P140-P141 UK二进二出接线端子 1-1 Feed Through Terminal Block		303941	305941							
P142-P144 UK接地端子 UK Ground Terminal Block		302903	303903	305903	306903	310903	316903	335903	350903	
P145-P147 SUK接线端子 SUK Terminal Block		302991	303991	305991	306991	310991	316991	335991		
P148-P150 SUK接地端子 SUK Ground Terminal Block		306993	306993	310993	316993	335993	302993	303993		
P151-P152 UKD 接线端子 UKD Terminal Block		303921	305921	305921-PV	310921	310921-PV				
P153-P154 分断测试 test terminal		SUK6-T	SUK6-T-JP	306911	305972					

TB系列微型弹簧接线端子 TB Rail-mounted Miniature Terminal Blocks

P157-P159 240系列侧面接线端子 240 With Fixing Flanges of Side-entry		240301	240331	240311	240341	240321	240351
-------------------------------------------------------------------	---------------------------------------------------------------------------------------	--------	--------	--------	--------	--------	--------

P160-P162 241系列侧面接线端子 241 With Fixing Flanges of Side-entry						
P163-P165 242系列侧面接线端子 242 With Fixing Flanges of Side-entry						
P166-P168 254系列正面接线端子 254 With Fixing Flanges of Front-entry						
P169-P171 254系列正面端子 254 Serie Front-entry						

附件 Accessory

P173-P174 终端固定器 End stop		215201	P180-P181 UK系列跨接桥 UK Jumper		302302
P174 终端标识牌 End stop marking		215214	P181 TB系列跨接桥 TB Jumper		240601
P175 导轨转换器 Rail transf		254611	P182 导轨防护盖 Rails lid		920001
P176 分组隔片 Septum		ATP-TU	P182-P183 导轨 Rails		900421/011
P176 保护盖板 Butt Plate		900611	P183-P184 弹簧接线端子专用工具 Special tools for spring terminal blocks		910111
P177-P179 TP/TU/TC系列跨接桥 TP/TU/TC Jumper		TJA-3.5	P184-P185 标记牌 Marker card		214801
P178-P179 TA系列跨接桥 TA Jumper		215301			

TP系列弹簧接线端子

TP Rail-mounted Terminal Blocks With Spring-cage Clamp

TP系列弹簧接线端子采用直插式弹簧接线技术，无需借助特定工具即可完成导线的快速连接，适于各种操作场合。该产品最突出的优点在于操作简便，无需使用特定接线工具，大大减小插入力。产品设计制造符合IEC/EN60947、UL1059等相关国际标准。

TP series adopt the push-in type spring cage connection technology, can finish the quick wiring without any special tool, can be operated in different environments. The most advantage for this series is convenient operation, on need to use wiring tool, also greatly deduct the insert force. The products have the international standards including IEC/EN60947, UL1059 ect.

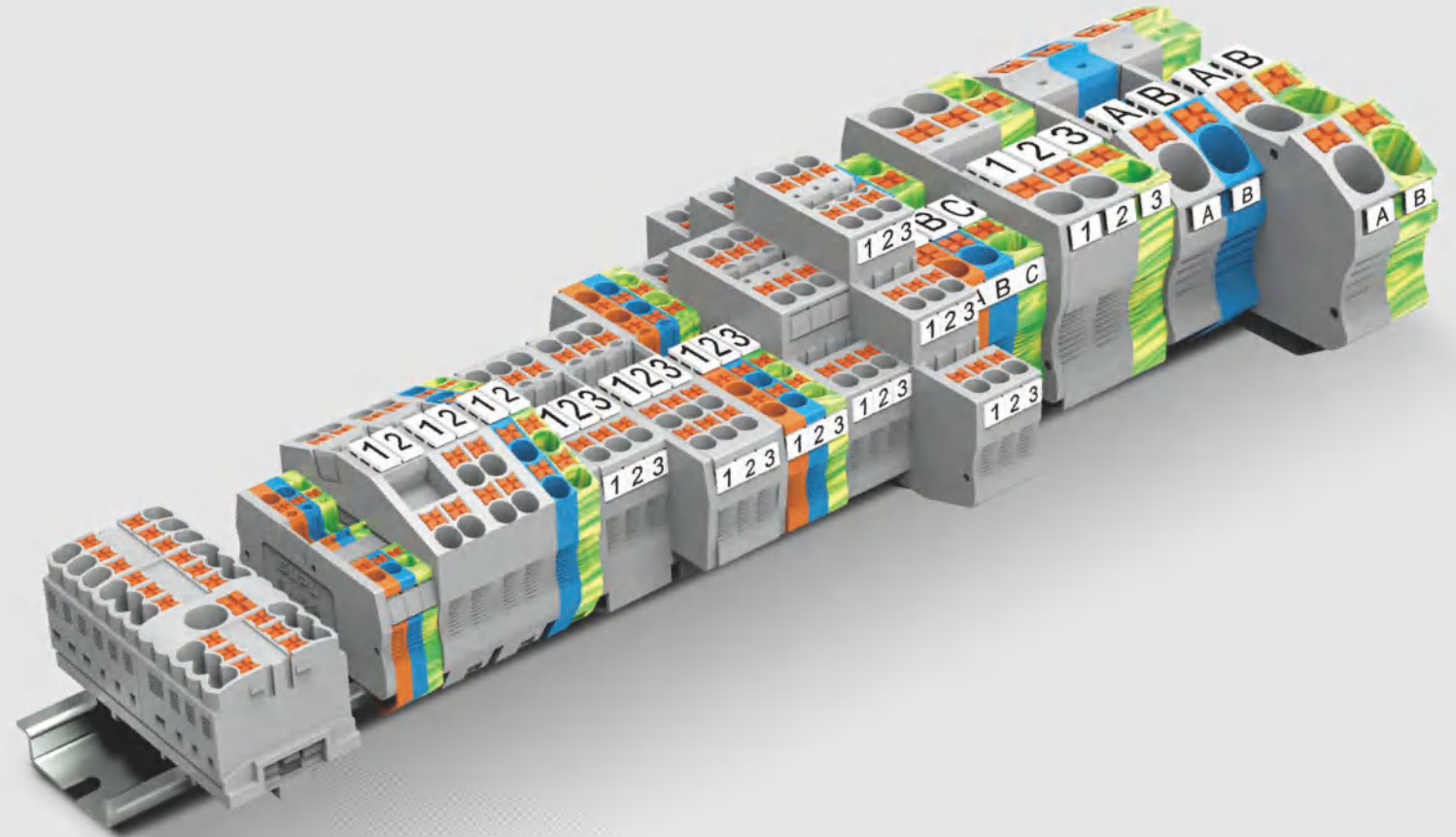

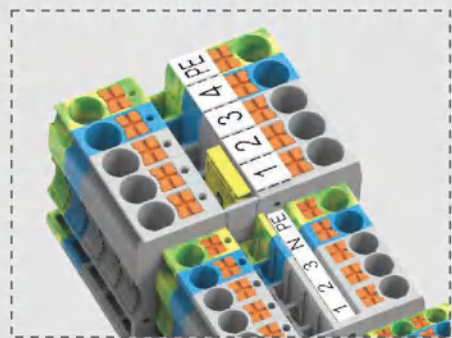

▲ 带辅助按键，无需特定工具，不接触带电部件

▲ With the press key, no special tools are required and no live parts are touched

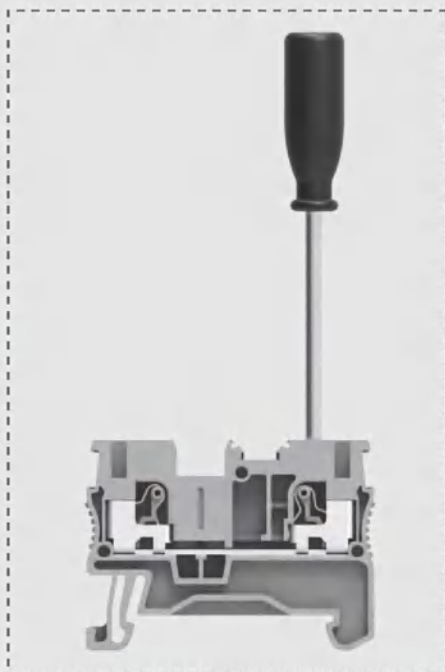

▲ 按下辅助按键即可打开弹簧，接入柔性导线

▲ Inserting the flexible conductor via the press key

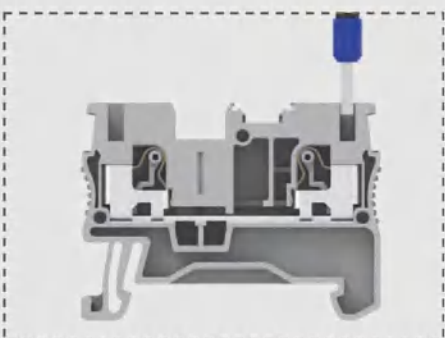

▲ 线径0.2 mm²以上的刚性导线或带0.34 mm²以上冷压头的导线可直接接入

▲ The solid wire $\geq 0.25\text{mm}^2$ and the wire with ferrule $\geq 0.34\text{mm}^2$ can be inserted directly

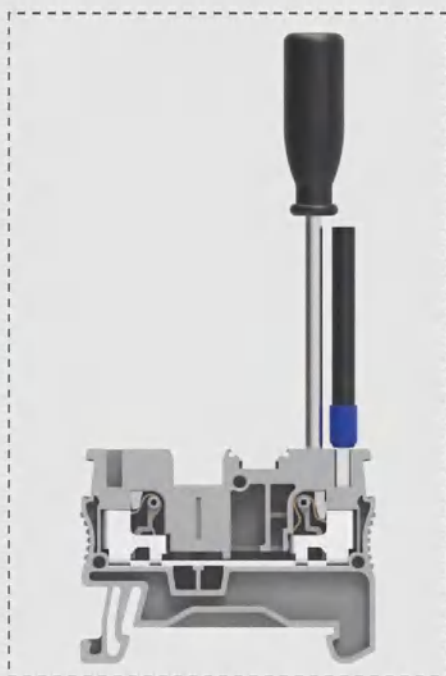

▲ 按下辅助按键，即可退线

▲ Removing the conductor via the press key

TP系列弹簧接线端子

TP Rail-mounted terminal blocks with spring-cage clamp

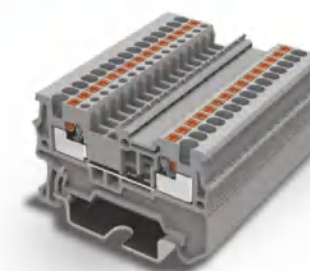

1.5mm² 一进一出接线端子
1-1 Feed Through Terminal Block

技术参数Technical Parameter			
厚度Thickness	宽度Width	高度Height	
3.5	48	30.5	
IEC	UL		
额定电压Rated Voltage [V]	500	600	
额定电流Rated Current [A]	17.5	15	
接线容量Wire Range	刚性Solid	柔性Fine Stranded	带冷压头Ferrule
	0.2-1.5	0.2-1.5	0.2-1.5
	[mm ²]	[mm ²]	[mm ²]
	26-14	26-14	26-14
	[AWG]	[AWG]	[AWG]
其余参数Other Parameters			
绝缘材料/阻燃等级, 符合UL94 Insulating Material / Flame Retardant Grade, Conforming To UL94			
剥线长度Strip length [mm]			
V0			
8-9			

订货信息Order Information	
产品Product	颜色Colour
适配NS 35/7.5导轨 Can Be Used For DIN Rail NS 35/7.5	灰Gray 橙Orange 蓝Blue
配套附件Accessory	
端板Cover Plate	厚度2.2mm Thickness2.2mm
补偿端板Compensatory Plate	厚度1.00mm Thickness1.00mm
跨接件Jumper	
位数Poles No.	颜色Colour
2	黄Yellow
3	黄Yellow
4	黄Yellow
...
9	黄Yellow
10	黄Yellow
正面标记Front Marker	
10位PCS	*
正面标记和侧面标记Front And Side Marker	
可提供印字服务Printing Service	TMB3.5-100

订货信息Order Information	
产品Product	颜色Colour
适配NS 35/7.5导轨 Can Be Used For DIN Rail NS 35/7.5	灰Gray 橙Orange 蓝Blue
配套附件Accessory	
端板Cover Plate	厚度2.2mm Thickness2.2mm
补偿端板Compensatory Plate	厚度1.00mm Thickness1.00mm
跨接件Jumper	
位数Poles No.	颜色Colour
2	黄Yellow
3	黄Yellow
4	黄Yellow
...
9	黄Yellow
10	黄Yellow
正面标记Front Marker	
10位PCS	*
正面标记和侧面标记Front And Side Marker	
可提供印字服务Printing Service	TMB3.5-100

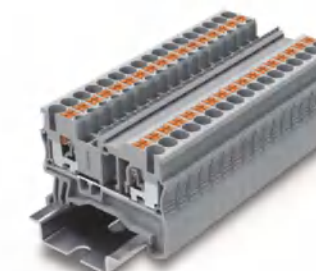

2.5mm² 一进一出接线端子
1-1 Feed Through Terminal Block

技术参数Technical Parameter			
厚度Thickness	宽度Width	高度Height	
5.2	48.2	35.2	
IEC	UL		
额定电压Rated Voltage [V]	800	600	
额定电流Rated Current [A]	24	20	
接线容量Wire Range	刚性Solid	柔性Fine Stranded	带冷压头Ferrule
	0.2-4	0.2-2.5	0.2-2.5
	[mm ²]	[mm ²]	[mm ²]
	26-12	26-12	26-12
	[AWG]	[AWG]	[AWG]
其余参数Other Parameters			
绝缘材料/阻燃等级, 符合UL94 Insulating Material / Flame Retardant Grade, Conforming To UL94			
剥线长度Strip length [mm]			
V0			
8-10			

订货信息Order Information	
产品Product	颜色Colour
适配NS 35/7.5导轨 Can Be Used For DIN Rail NS 35/7.5	灰Gray 橙Orange 蓝Blue
配套附件Accessory	
端板Cover Plate	厚度2.2mm Thickness2.2mm
补偿端板Compensatory Plate	厚度1.00mm Thickness1.00mm
跨接件Jumper	
位数Poles No.	颜色Colour
2	黄Yellow
3	黄Yellow
4	黄Yellow
...
9	黄Yellow
10	黄Yellow
正面标记Front Marker	
10位PCS	*
正面标记和侧面标记Front And Side Marker	
可提供印字服务Printing Service	TMB3.5-100

订货信息Order Information	
产品Product	颜色Colour
适配NS 35/7.5导轨 Can Be Used For DIN Rail NS 35/7.5	灰Gray 橙Orange 蓝Blue
配套附件Accessory	
端板Cover Plate	厚度2.2mm Thickness2.2mm
补偿端板Compensatory Plate	厚度1.00mm Thickness1.00mm
跨接件Jumper	
位数Poles No.	颜色Colour
2	黄Yellow
3	黄Yellow
4	黄Yellow
...
9	黄Yellow
10	黄Yellow
正面标记Front Marker	
10位PCS	*
正面标记和侧面标记Front And Side Marker	
可提供印字服务Printing Service	TMB3.5-100

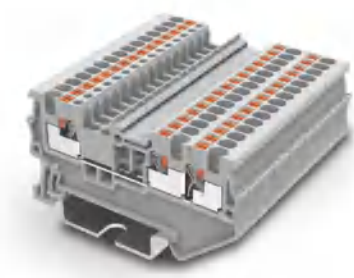
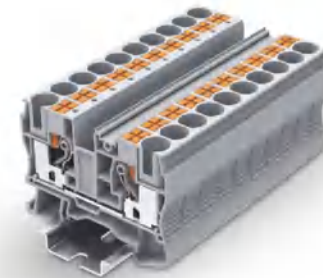

4mm² 一进一出接线端子
1-1 Feed Through Terminal Block

6mm² 一进一出接线端子
1-1 Feed Through Terminal Block

10mm² 一进一出接线端子
1-1 Feed Through Terminal Block

16mm² 一进一出接线端子
1-1 Feed Through Terminal Block

1.5mm² 一进两出接线端子
1-2 Feed Through Terminal Block

尺寸Size	
注: 安装NS35/7.5导轨后的高度 Note: Height With DIN Rail NS 35/7.5	[mm]
额定电压Rated Voltage	[V]
额定电流Rated Current	[A]
接线容量Wire Range	
	[mm ²]
	[AWG]
其余参数Other Parameters	
绝缘材料/阻燃等级, 符合UL94 Insulating Material / Flame Retardant Grade, Conforming To UL94	
剥线长度Strip length	[mm]
产品Product	
颜色Colour	灰Gray 橙Orange 蓝Blue
适配NS 35/7.5导轨 Can Be Used For DIN Rail NS 35/7.5	
盖板Cover Plate	
厚度2.2mm Thickness2.2mm	灰Gray 橙Orange 蓝Blue
补偿盖板Compensatory Plate	
厚度1.00mm Thickness1.00mm	灰Gray
跨接件Jumper	
位数Poles No.	颜色Colour
2	黄Yellow
3	黄Yellow
4	黄Yellow
...
9	黄Yellow
10	黄Yellow
正面标记Front Marker	
10位PCS	
正面标记和侧面标记Front And Side Marker	
可提供印字服务Printing Service	

技术参数Technical Parameter		
厚度Thickness	宽度Width	高度Height
6.2	54.9	35.5
IEC	UL	
800	600	
32	30	
接线容量Wire Range		
刚性Solid	柔性Fine Stranded	带冷压头Furrule
0.2-6	0.2-4	0.2-4
24-10	24-10	24-10
其余参数Other Parameters		
绝缘材料/阻燃等级, 符合UL94 Insulating Material / Flame Retardant Grade, Conforming To UL94		
剥线长度Strip length [mm]		
10-12		
订货信息Order Information		
订货号Order NO.		
TP4-2-GY		
TP4-2-OG		
TP4-2-BU		
配套附件Accessory		
订货号Order NO.		
TC4-2-GY-EA		
TC4-2-OG-EA		
TC4-2-BU-EA		
订货号Order NO.		
*		
跨接件Jumper		
位数Poles No.		
颜色Colour		
2		
3		
4		
...		
9		
10		
正面标记Front Marker		
10位PCS		
正面标记和侧面标记Front And Side Marker		
可提供印字服务Printing Service		

技术参数Technical Parameter		
厚度Thickness	宽度Width	高度Height
8.2	58	42.2
IEC	UL	
1000	600	
41	40	
接线容量Wire Range		
刚性Solid	柔性Fine Stranded	带冷压头Furrule
0.5-10	0.5-6	0.5-6
20-8	20-8	20-8
其余参数Other Parameters		
绝缘材料/阻燃等级, 符合UL94 Insulating Material / Flame Retardant Grade, Conforming To UL94		
剥线长度Strip length [mm]		
10-12		
订货信息Order Information		
订货号Order NO.		
TP6-2-GY		
TP6-2-OG		
TP6-2-BU		
配套附件Accessory		
订货号Order NO.		
TP6-2-GY-EA		
TP6-2-OG-EA		
TP6-2-BU-EA		
订货号Order NO.		
*		
跨接件Jumper		
位数Poles No.		
颜色Colour		
2		
3		
4		
...		
9		
10		
正面标记Front Marker		
10位PCS		
正面标记和侧面标记Front And Side Marker		
可提供印字服务Printing Service		

技术参数Technical Parameter		
厚度Thickness	宽度Width	高度Height
10.2	67.7	49.6
IEC	UL	
1000	600	
57	60	
接线容量Wire Range		
刚性Solid	柔性Fine Stranded	带冷压头Furrule
0.5-16	0.5-10	0.5-10
20-6	20-6	20-6
其余参数Other Parameters		
绝缘材料/阻燃等级, 符合UL94 Insulating Material / Flame Retardant Grade, Conforming To UL94		
剥线长度Strip length [mm]		
18		
订货信息Order Information		
订货号Order NO.		
TP10-2-GY		
TP10-2-OG		
TP10-2-BU		
配套附件Accessory		
订货号Order NO.		
TP10-2-GY-EA		
TP10-2-OG-EA		
TP10-2-BU-EA		
订货号Order NO.		
*		
跨接件Jumper		
位数Poles No.		
颜色Colour		
2		
3		
4		
...		
9		
10		
正面标记Front Marker		
10位PCS		
正面标记和侧面标记Front And Side Marker		
可提供印字服务Printing Service		

技术参数Technical Parameter		
厚度Thickness	宽度Width	高度Height
12.2	75.4	52.6
IEC	UL	
1000	600	
76	85	
接线容量Wire Range		
刚性Solid	柔性Fine Stranded	带冷压头Furrule
0.5-25	0.5-16	0.5-16
20-4	20-04	20-4
其余参数Other Parameters		
绝缘材料/阻燃等级, 符合UL94 Insulating Material / Flame Retardant Grade, Conforming To UL94		
剥线长度Strip length [mm]		
18		
订货信息Order Information		
订货号Order NO.		
TP16-2-GY		
TP16-2-OG		
TP16-2-BU		
配套附件Accessory		
订货号Order NO.		
TP16-2-GY-EA		
TP16-2-OG-EA		
TP16-2-BU-EA		
订货号Order NO.		
*		
跨接件Jumper		
位数Poles No.		
颜色Colour		
2		
3		
4		
...		
9		
10		
正面标记Front Marker		
10位PCS		
正面标记和侧面标记Front And Side Marker		
可提供印字服务Printing Service		

技术参数Technical Parameter		
厚度Thickness	宽度Width	高度Height
3.5	57.1	30.5
IEC	UL	
500	600	
17.5	15	
接线容量Wire Range		
刚性Solid	柔性Fine Stranded	带冷压头Furrule
0.2-1.5	0.2-1.5	0.2-1.5
26-14	26-14	26-14
其余参数Other Parameters		
绝缘材料/阻燃等级, 符合UL94 Insulating Material / Flame Retardant Grade, Conforming To UL94		
剥线长度Strip length [mm]		
8-9		
订货信息Order Information		
订货号Order NO.		
TP1.5-3-GY		
TP1.5-3-OG		
TP1.5-3-BU		
配套附件Accessory		
订货号Order NO.		
TP1.5-3-GY-EA		
TP1.5-3-OG-EA		
TP1.5-3-BU-EA		
订货号Order NO.		
*		
跨接件Jumper		
位数Poles No.		
颜色Colour		
2		
3		
4		
...		
9		
10		
正面标记Front Marker		
10位PCS		
正面标记和侧面标记Front And Side Marker		
可提供印字服务Printing Service		

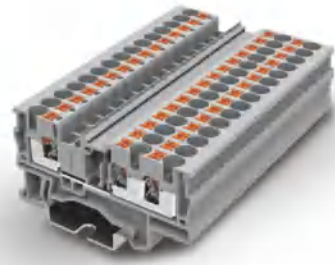
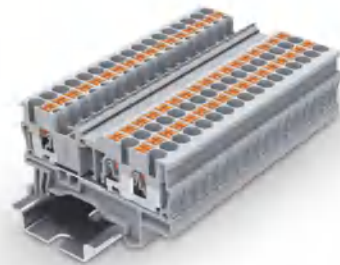

尺寸Size	
注: 安装NS35/7.5导轨后的高度 Note: Height With DIN Rail NS 35/7.5	[mm]
额定电压Rated Voltage	[V]
额定电流Rated Current	[A]
接线容量Wire Range	
	[mm²]
	[AWG]
其余参数Other Parameters	
绝缘材料/阻燃等级, 符合UL94 Insulating Material / Flame Retardant Grade, Conforming To UL94	
剥线长度Strip length	[mm]
产品Product	
颜色Colour	
适配NS 35/7.5导轨 Can Be Used For DIN Rail NS 35/7.5	灰Gray 橙Orange 蓝Blue
端板Cover Plate	
厚度2.2mm Thickness2.2mm	灰Gray 橙Orange 蓝Blue
补偿端板Compensatory Plate	
厚度1.00mm Thickness1.00mm	灰Gray
跨接件Jumper	
位数Poles No.	颜色Colour
2	黄Yellow
3	黄Yellow
4	黄Yellow
...
9	黄Yellow
10	黄Yellow
正面标记Front Marker	
10位PCS	
正面标记和侧面标记Front And Side Marker	
可提供印字服务Printing Service	

2.5mm² 一进两出接线端子 1-2 Feed Through Terminal Block		
技术参数Technical Parameter		
厚度Thickness	宽度Width	高度Height
5.2	60.2	35.2
IEC	UL	
800	600	
24	20	
接线容量Wire Range		
刚性Solid	柔性Fine Stranded	带冷压头Furrule
0.2-4	0.2-2.5	0.2-2.5
26-12	26-12	26-12
其余参数Other Parameters		
绝缘材料/阻燃等级, 符合UL94 Insulating Material / Flame Retardant Grade, Conforming To UL94		
剥线长度Strip length [mm]		
V0		
8-10		
订货信息Order Information		
订货号Order NO.		
TP2.5-3-GY		
TP2.5-3-OG		
TP2.5-3-BU		
配套附件Accessory		
订货号Order NO.		
TC1.5-3-GY-EA		
TC1.5-3-OG-EA		
TC1.5-3-BU-EA		
订货号Order NO.		
*		
跨接件Jumper		
位数Poles No.		
颜色Colour		
订货号Order NO.		
TJA5.2-2		
TJA5.2-3		
TJA5.2-4		
.....		
TJA5.2-9		
TJA5.2-10		
正面标记Front Marker		
订货号Order NO.		
305801		
正面标记和侧面标记Front And Side Marker		
订货号Order NO.		
TMB5.2-120		

4mm² 一进两出接线端子 1-2 Feed Through Terminal Block		
技术参数Technical Parameter		
厚度Thickness	宽度Width	高度Height
6.2	66.3	35.5
IEC	UL	
800	600	
32	30	
接线容量Wire Range		
刚性Solid	柔性Fine Stranded	带冷压头Furrule
0.2-6	0.2-4	0.2-4
24-10	24-10	24-10
其余参数Other Parameters		
绝缘材料/阻燃等级, 符合UL94 Insulating Material / Flame Retardant Grade, Conforming To UL94		
剥线长度Strip length [mm]		
V0		
10-12		
订货信息Order Information		
订货号Order NO.		
TP4-3-GY		
TP4-3-OG		
TP4-3-BU		
配套附件Accessory		
订货号Order NO.		
TP4-3-GY-EA		
TP4-3-OG-EA		
TP4-3-BU-EA		
订货号Order NO.		
*		
跨接件Jumper		
位数Poles No.		
颜色Colour		
订货号Order NO.		
TJA6.2-2		
TJA6.2-3		
TJA6.2-4		
.....		
TJA6.2-9		
TJA6.2-10		
正面标记Front Marker		
订货号Order NO.		
306801		
正面标记和侧面标记Front And Side Marker		
订货号Order NO.		
TMB6.2-100		

6mm² 一进两出接线端子 1-2 Feed Through Terminal Block		
技术参数Technical Parameter		
厚度Thickness	宽度Width	高度Height
8.2	74.5	42.2
IEC	UL	
1000	600	
41	40	
接线容量Wire Range		
刚性Solid	柔性Fine Stranded	带冷压头Furrule
0.5-10	0.5-6	0.5-6
20-8	20-8	20-8
其余参数Other Parameters		
绝缘材料/阻燃等级, 符合UL94 Insulating Material / Flame Retardant Grade, Conforming To UL94		
剥线长度Strip length [mm]		
V0		
10-12		
订货信息Order Information		
订货号Order NO.		
TP6-3-GY		
TP6-3-OG		
TP6-3-BU		
配套附件Accessory		
订货号Order NO.		
TP6-3-GY-EA		
TP6-3-OG-EA		
TP6-3-BU-EA		
订货号Order NO.		
*		
跨接件Jumper		
位数Poles No.		
颜色Colour		
订货号Order NO.		
TJA8.2-2		
TJA8.2-3		
TJA8.2-4		
.....		
TJA8.2-9		
TJA8.2-10		
正面标记Front Marker		
订货号Order NO.		
308801		
正面标记和侧面标记Front And Side Marker		
订货号Order NO.		
TMB8.2-50		

10mm² 一进两出接线端子 1-2 Feed Through Terminal Block		
技术参数Technical Parameter		
厚度Thickness	宽度Width	高度Height
10.2	88.9	49.6
IEC	UL	
1000	600	
57	60	
接线容量Wire Range		
刚性Solid	柔性Fine Stranded	带冷压头Furrule
0.5-16	0.5-10	0.5-10
20-6	20-6	20-6
其余参数Other Parameters		
绝缘材料/阻燃等级, 符合UL94 Insulating Material / Flame Retardant Grade, Conforming To UL94		
剥线长度Strip length [mm]		
V0		
18		
订货信息Order Information		
订货号Order NO.		
TP10-3-GY		
TP10-3-OG		
TP10-3-BU		
配套附件Accessory		
订货号Order NO.		
TP10-3-GY-EA		
TP10-3-OG-EA		
TP10-3-BU-EA		
订货号Order NO.		
*		
跨接件Jumper		
位数Poles No.		
颜色Colour		
订货号Order NO.		
TJA10.2-2		
.....		
TJA10.2-9		
TJA10.2-10		
正面标记Front Marker		
订货号Order NO.		
TMB10.2-10		
正面标记和侧面标记Front And Side Marker		
订货号Order NO.		
TMB8.2-50		

16mm² 一进两出接线端子 1-2 Feed Through Terminal Block		
技术参数Technical Parameter		
厚度Thickness	宽度Width	高度Height
12.2	100.4	52.6
IEC	UL	
*	*	
*	*	
接线容量Wire Range		
刚性Solid	柔性Fine Stranded	带冷压头Furrule
0.5-25	0.5-16	0.5-16
20-4	20-4	20-4
其余参数Other Parameters		
绝缘材料/阻燃等级, 符合UL94 Insulating Material / Flame Retardant Grade, Conforming To UL94		
剥线长度Strip length [mm]		
V0		
18		
订货信息Order Information		
订货号Order NO.		
TP16-3-GY		
TP16-3-OG		
TP16-3-BU		
配套附件Accessory		
订货号Order NO.		
TP16-3-GY-EA		
TP16-3-OG-EA		
TP16-3-BU-EA		
订货号Order NO.		
*		
跨接件Jumper		
位数Poles No.		
颜色Colour		
订货号Order NO.		
TJA12.2-2		
.....		
TJA12.2-9		
TJA12.2-10		
正面标记Front Marker		
订货号Order NO.		
TMB10.2-10		
正面标记和侧面标记Front And Side Marker		
订货号Order NO.		
TMB8.2-50		

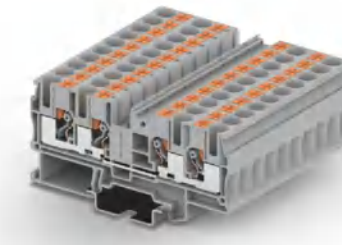
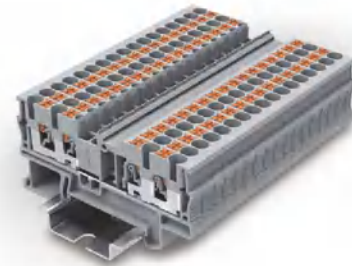
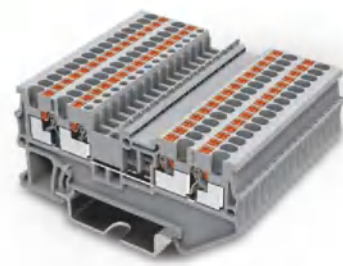

	1.5mm ² 两进两出接线端子 2-2 Feed Through Terminal Block			2.5mm ² 两进两出接线端子 2-2 Feed Through Terminal Block		
	技术参数Technical Parameter			技术参数Technical Parameter		
尺寸Size	厚度Thickness	宽度Width	高度Height	厚度Thickness	宽度Width	高度Height
注: 安装NS35/7.5导轨后的高度 Note: Height With DIN Rail NS 35/7.5	3.5	65.2	30.5	5.2	72.2	35.3
额定参数Rated Parameters	IEC	UL		IEC	UL	
额定电压Rated Voltage	500	600		800	600	
额定电流Rated Current	17.5	15		24	20	
接线容量Wire Range	刚性Solid	柔性Fine Stranded	带冷压头Furrule	刚性Solid	柔性Fine Stranded	带冷压头Furrule
	0.2-1.5	0.2-1.5	0.2-1.5	0.2-4	0.2-2.5	0.2-2.5
	26-14	26-14	26-14	26-12	26-12	26-12
其余参数Other Parameters						
绝缘材料/阻燃等级, 符合UL94 Insulating Material / Flame Retardant Grade, Conforming To UL94	V0			V0		
剥线长度Strip length	8-9			8-10		
产品信息Order Information	订货号Order NO.			订货号Order NO.		
产品Product	颜色Colour			颜色Colour		
适配NS 35/7.5导轨 Can Be Used For DIN Rail NS 35/7.5	灰Gray			灰Gray		
	橙Orange			橙Orange		
	蓝Blue			蓝Blue		
配套附件Accessory	订货号Order NO.			订货号Order NO.		
端板Cover Plate	TP1.5-4-GY-EA			TC1.5-4-GY-EA		
厚度2.2mm Thickness2.2mm	TP1.5-4-OG-EA			TC1.5-4-OG-EA		
	TP1.5-4-BU-EA			TC1.5-4-BU-EA		
补偿端板Compensatory Plate	订货号Order NO.			订货号Order NO.		
厚度1.00mm Thickness1.00mm	*			*		
跨接件Jumper	订货号Order NO.			订货号Order NO.		
位数Poles No.	颜色Colour			颜色Colour		
2	黄Yellow			黄Yellow		
3	黄Yellow			黄Yellow		
4	黄Yellow			黄Yellow		
...		
9	黄Yellow			黄Yellow		
10	黄Yellow			黄Yellow		
正面标记Front Marker	订货号Order NO.			订货号Order NO.		
10位PCS	*			305801		
正面标记和侧面标记Front And Side Marker	订货号Order NO.			订货号Order NO.		
可提供印字服务Printing Service	TMB3.5-100			TMB5.2-120		

	4mm ² 两进两出接线端子 2-2 Feed Through Terminal Block			6mm ² 两进两出接线端子 2-2 Feed Through Terminal Block		
	技术参数Technical Parameter			技术参数Technical Parameter		
厚度Thickness	宽度Width	高度Height	厚度Thickness	宽度Width	高度Height	
6.2	77.7	35.5	8.2	91	42.2	
IEC	UL		IEC	UL		
800	600		1000	600		
32	30		41	40		
刚性Solid	柔性Fine Stranded	带冷压头Furrule	刚性Solid	柔性Fine Stranded	带冷压头Furrule	
0.2-6	0.2-4	0.2-4	0.5-10	0.5-6	0.5-6	
24-10	24-10	24-10	20-8	20-8	20-8	
其余参数Other Parameters						
绝缘材料/阻燃等级, 符合UL94 Insulating Material / Flame Retardant Grade, Conforming To UL94	V0			V0		
剥线长度Strip length	10-12			10-12		
产品信息Order Information	订货号Order NO.			订货号Order NO.		
产品Product	颜色Colour			颜色Colour		
适配NS 35/7.5导轨 Can Be Used For DIN Rail NS 35/7.5	灰Gray			灰Gray		
	橙Orange			橙Orange		
	蓝Blue			蓝Blue		
配套附件Accessory	订货号Order NO.			订货号Order NO.		
端板Cover Plate	TP4-4-GY-EA			TP6-4-GY-EA		
厚度2.2mm Thickness2.2mm	TP4-4-OG-EA			TP6-4-OG-EA		
	TP4-4-BU-EA			TP6-4-BU-EA		
补偿端板Compensatory Plate	订货号Order NO.			订货号Order NO.		
厚度1.00mm Thickness1.00mm	*			*		
跨接件Jumper	订货号Order NO.			订货号Order NO.		
位数Poles No.	颜色Colour			颜色Colour		
2	黄Yellow			黄Yellow		
3	黄Yellow			黄Yellow		
4	黄Yellow			黄Yellow		
...		
9	黄Yellow			黄Yellow		
10	黄Yellow			黄Yellow		
正面标记Front Marker	订货号Order NO.			订货号Order NO.		
10位PCS	306801			308801		
正面标记和侧面标记Front And Side Marker	订货号Order NO.			订货号Order NO.		
可提供印字服务Printing Service	TMB6.2-100			TMB8.2-50		

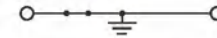
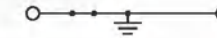
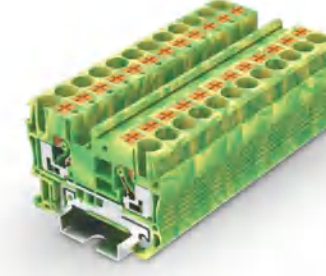
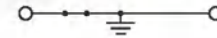
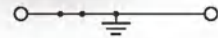
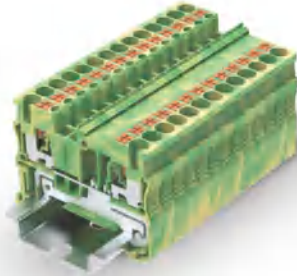
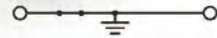
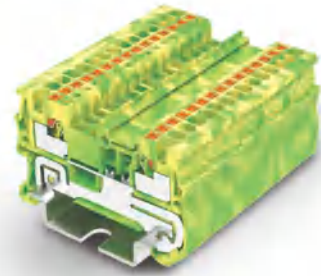

	1.5mm ² 一进一出接地端子 1-1 Feed Through Ground Terminal Block			2.5mm ² 一进一出接地端子 1-1 Feed Through Ground Terminal Block			4mm ² 一进一出接地端子 1-1 Feed Through Ground Terminal Block			6mm ² 一进一出接地端子 1-1 Feed Through Ground Terminal Block			10mm ² 一进一出接地端子 1-1 Feed Through Ground Terminal Block				
	技术参数Technical Parameter			技术参数Technical Parameter			技术参数Technical Parameter			技术参数Technical Parameter			技术参数Technical Parameter				
尺寸Size	厚度Thickness	宽度Width	高度Height	厚度Thickness	宽度Width	高度Height	厚度Thickness	宽度Width	高度Height	厚度Thickness	宽度Width	高度Height	厚度Thickness	宽度Width	高度Height		
注: 安装NS35/7.5导轨后的高度 Note: Height With DIN Rail NS 35/7.5	[mm]	3.5	48	30.5	5.2	48.2	35.2	6.2	54.9	35.5	8.2	58	42.2	10.2	67.7	49.6	
额定参数Rated Parameters	IEC	UL		IEC	UL		IEC	UL		IEC	UL		IEC	UL		IEC	UL
额定电压Rated Voltage	[V]	*	*	*	*	*	*	*	*	*	*	*	*	*	*	*	*
额定电流Rated Current	[A]	*	*	*	*	*	*	*	*	*	*	*	*	*	*	*	*
接线容量Wire Range	[mm ²]	刚性Solid	柔性Fine Stranded	带冷压头Furrule	刚性Solid	柔性Fine Stranded	带冷压头Furrule	刚性Solid	柔性Fine Stranded	带冷压头Furrule	刚性Solid	柔性Fine Stranded	带冷压头Furrule	刚性Solid	柔性Fine Stranded	带冷压头Furrule	
	[AWG]	0.2-1.5	0.2-1.5	0.2-1.5	0.2-4	0.2-2.5	0.2-2.5	0.2-6	0.2-4	0.2-4	0.5-10	0.5-6	0.5-6	0.5-16	0.5-10	0.5-10	
		26-14	26-14	26-14	26-12	26-12	26-12	24-10	24-10	24-10	20-8	20-8	20-8	20-6	20-6	20-6	
其余参数Other Parameters																	
绝缘材料/阻燃等级, 符合UL94 Insulating Material / Flame Retardant Grade, Conforming To UL94		V0			V0			V0			V0			V0			
剥线长度Strip length	[mm]	8-9			8-10			10-12			10-12			18			
产品信息Order Information	颜色Colour	订货号Order NO.			订货号Order NO.			订货号Order NO.			订货号Order NO.			订货号Order NO.			
产品Product	黄色Yellow green	TP1.5-2-PE			TP2.5-2-PE			TP4-2-PE			TP6-2-PE			TP10-2-PE			
适配NS 35/7.5导轨 Can Be Used For DIN Rail NS 35/7.5	*	*			*			*			*			*			
	*	*			*			*			*			*			
配套附件Accessory		订货号Order NO.			订货号Order NO.			订货号Order NO.			订货号Order NO.			订货号Order NO.			
端板Cover Plate	灰Gray	TP1.5-2-GY-EA			TP2.5-2-GY-EA			TC4-2-GY-EA			TP6-2-GY-EA			TP10-2-GY-EA			
厚度2.2mm Thickness2.2mm	橙Orange	TP1.5-2-OG-EA			TP2.5-2-OG-EA			TC4-2-OG-EA			TP6-2-OG-EA			TP10-2-OG-EA			
	蓝Blue	TP1.5-2-BU-EA			TP2.5-2-BU-EA			TC4-2-BU-EA			TP6-2-BU-EA			TP10-2-BU-EA			
补偿端板Compensatory Plate	灰Gray	订货号Order NO.			订货号Order NO.			订货号Order NO.			订货号Order NO.			订货号Order NO.			
厚度1.00mm Thickness1.00mm		*			*			*			*			*			
跨接件Jumper		订货号Order NO.			订货号Order NO.			订货号Order NO.			订货号Order NO.			订货号Order NO.			
位数Poles No.	颜色Colour	TJA3.5-2			TJA5.2-2			TJA6.2-2			TJA8.2-2			TJA10.2-2			
2	黄Yellow	TJA3.5-3			TJA5.2-3			TJA6.2-3			TJA8.2-3			*			
3	黄Yellow	TJA3.5-4			TJA5.2-4			TJA6.2-4			TJA8.2-4			*			
4	黄Yellow			
...	TJA3.5-9			TJA5.2-9			TJA6.2-9			TJA8.2-9			*			
9	黄Yellow	TJA3.5-10			TJA5.2-10			TJA6.2-10			TJA8.2-10			*			
10	黄Yellow	订货号Order NO.			订货号Order NO.			订货号Order NO.			订货号Order NO.			订货号Order NO.			
正面标记Front Marker		*			305801			306801			308801			TMB10.2-10			
10位PCS		订货号Order NO.			订货号Order NO.			订货号Order NO.			订货号Order NO.			订货号Order NO.			
正面标记和侧面标记Front And Side Marker		TMB3.5-100			TMB5.2-120			TMB6.2-100			TMB8.2-50			TMB8.2-50			
可提供印字服务Printing Service																	

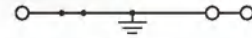

16mm² 一进一出接地端子
1-1 Feed Through Ground Terminal Block

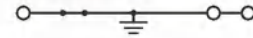
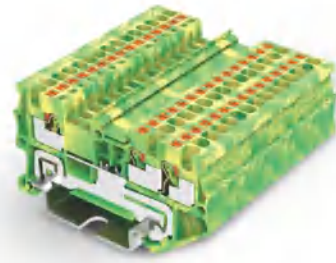

1.5mm² 一进两出接地端子
1-2 Feed Through Ground Terminal Block

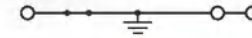
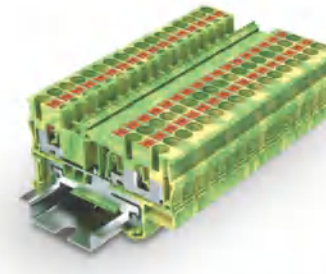

2.5mm² 一进两出接地端子
1-2 Feed Through Ground Terminal Block

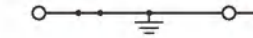

4mm² 一进两出接地端子
1-2 Feed Through Ground Terminal Block

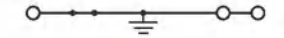

6mm² 一进两出接地端子
1-2 Feed Through Ground Terminal Block

尺寸Size	
注: 安装NS35/7.5导轨后的高度 Note: Height With DIN Rail NS 35/7.5	[mm]
额定电压Rated Voltage	[V]
额定电流Rated Current	[A]
接线容量Wire Range	
	[mm ²]
	[AWG]
其余参数Other Parameters	
绝缘材料/阻燃等级, 符合UL94 Insulating Material / Flame Retardant Grade, Conforming To UL94	V0
剥线长度Strip length	[mm]
产品Product	颜色Colour
适配NS 35/7.5导轨 Can Be Used For DIN Rail NS 35/7.5	黄Yellow green
端板Cover Plate	灰Gray
厚度2.2mm Thickness2.2mm	橙Orange
	蓝Blue
补偿端板Compensatory Plate	灰Gray
厚度1.00mm Thickness1.00mm	灰Gray
跨接件Jumper	颜色Colour
位数Poles No.	黄Yellow
2	黄Yellow
3	黄Yellow
4	黄Yellow
...
9	黄Yellow
10	黄Yellow
正面标记Front Marker	10位PCS
正面标记和侧面标记Front And Side Marker	可提供印字服务Printing Service

技术参数Technical Parameter		
厚度Thickness	宽度Width	高度Height
12.2	75.4	50.9
IEC	UL	
*	*	
*	*	
刚性Solid	柔性Fine Stranded	带冷压头Furrule
0.5-25	0.5-16	0.5-16
20-4	20-4	20-4
订货信息Order Information		
订货号Order NO.	TP16-2-PE	
*	*	
*	*	
配套附件Accessory		
订货号Order NO.	TP16-2-GY-EA	
	TP16-2-OG-EA	
	TP16-2-BU-EA	
订货号Order NO.	*	
订货号Order NO.	TJA12.2-2	
	*	
	*	
订货号Order NO.	TMB10.2-10	
	*	
订货号Order NO.	TMB8.2-50	

技术参数Technical Parameter		
厚度Thickness	宽度Width	高度Height
3.5	57.1	30.5
IEC	UL	
*	*	
*	*	
刚性Solid	柔性Fine Stranded	带冷压头Furrule
0.2-1.5	0.2-1.5	0.2-1.5
26-14	26-14	26-14
订货信息Order Information		
订货号Order NO.	TP1.5-3-PE	
*	*	
*	*	
配套附件Accessory		
订货号Order NO.	TP1.5-3-GY-EA	
	TP1.5-3-OG-EA	
	TP1.5-3-BU-EA	
订货号Order NO.	*	
订货号Order NO.	TJA3.5-2	
	TJA3.5-3	
	TJA3.5-4	
	
	TJA3.5-9	
	TJA3.5-10	
订货号Order NO.	*	
订货号Order NO.	TMB3.5-100	

技术参数Technical Parameter		
厚度Thickness	宽度Width	高度Height
5.2	60.2	35.2
IEC	UL	
*	*	
*	*	
刚性Solid	柔性Fine Stranded	带冷压头Furrule
0.2-4	0.2-2.5	0.2-2.5
26-12	26-12	26-12
订货信息Order Information		
订货号Order NO.	TP2.5-3-PE	
*	*	
*	*	
配套附件Accessory		
订货号Order NO.	TC1.5-3-GY-EA	
	TC1.5-3-OG-EA	
	TC1.5-3-BU-EA	
订货号Order NO.	*	
订货号Order NO.	TJA5.2-2	
	TJA5.2-3	
	TJA5.2-4	
	
	TJA5.2-9	
	TJA5.2-10	
订货号Order NO.	305801	
订货号Order NO.	TMB5.2-120	

技术参数Technical Parameter		
厚度Thickness	宽度Width	高度Height
6.2	66.3	35.5
IEC	UL	
*	*	
*	*	
刚性Solid	柔性Fine Stranded	带冷压头Furrule
0.2-6	0.2-4	0.2-4
24-10	24-10	24-10
订货信息Order Information		
订货号Order NO.	TP4-3-PE	
*	*	
*	*	
配套附件Accessory		
订货号Order NO.	TP4-3-GY-EA	
	TP4-3-OG-EA	
	TP4-3-BU-EA	
订货号Order NO.	*	
订货号Order NO.	TJA6.2-2	
	TJA6.2-3	
	TJA6.2-4	
	
	TJA6.2-9	
	TJA6.2-10	
订货号Order NO.	306801	
订货号Order NO.	TMB6.2-100	

技术参数Technical Parameter		
厚度Thickness	宽度Width	高度Height
8.2	74.5	42.2
IEC	UL	
*	*	
*	*	
刚性Solid	柔性Fine Stranded	带冷压头Furrule
0.5-10	0.5-6	0.5-6
20-8	20-8	20-8
订货信息Order Information		
订货号Order NO.	TP6-3-PE	
*	*	
*	*	
配套附件Accessory		
订货号Order NO.	TP6-3-GY-EA	
	TP6-3-OG-EA	
	TP6-3-BU-EA	
订货号Order NO.	*	
订货号Order NO.	TJA8.2-2	
	TJA8.2-3	
	TJA8.2-4	
	
	TJA8.2-9	
	TJA8.2-10	
订货号Order NO.	308801	
订货号Order NO.	TMB8.2-50	

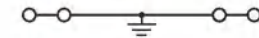
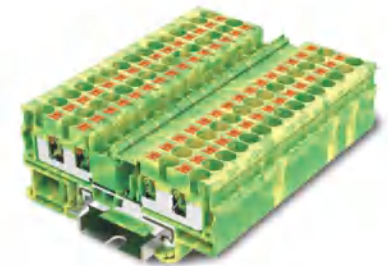
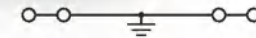
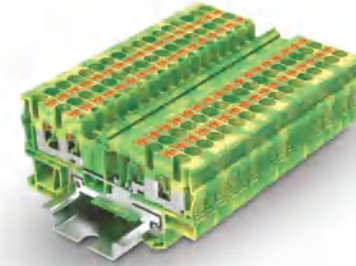
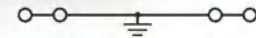
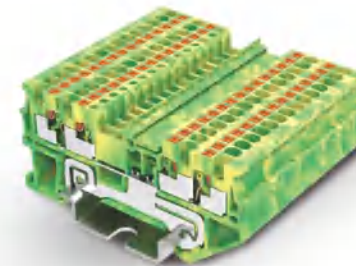
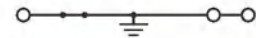
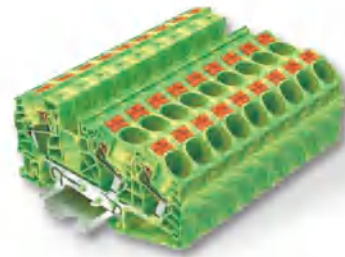
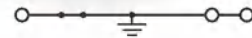
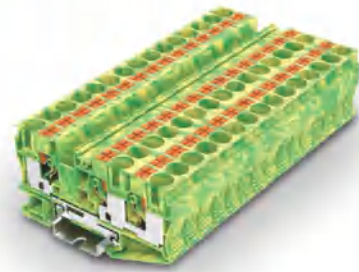

10mm² 一进两出接地端子
1-2 Feed Through Ground Terminal Block

16mm² 一进两出接地端子
1-2 Feed Through Ground Terminal Block

1.5mm² 两进两出接地端子
2-2 Feed Through Ground Terminal Block

2.5mm² 两进两出接地端子
2-2 Feed Through Ground Terminal Block

4mm² 两进两出接地端子
2-2 Feed Through Ground Terminal Block

尺寸Size	
注: 安装NS35/7.5导轨后的高度 Note: Height With DIN Rail NS 35/7.5	[mm]
额定参数Rated Parameters	
额定电压Rated Voltage	[V]
额定电流Rated Current	[A]
接线容量Wire Range	
	[mm ²]
	[AWG]
其余参数Other Parameters	
绝缘材料/阻燃等级, 符合UL94 Insulating Material / Flame Retardant Grade, Conforming To UL94	
剥线长度Strip length	[mm]

技术参数Technical Parameter		
厚度Thickness	宽度Width	高度Height
10.2	88.9	49.6
IEC	UL	
*	*	
*	*	
刚性Solid	柔性Fine Stranded	带冷压头Furrule
0.5-16	0.5-10	0.5-10
20-6	20-6	20-6
V0		
18		

技术参数Technical Parameter		
厚度Thickness	宽度Width	高度Height
12.2	100.4	52.6
IEC	UL	
*	*	
*	*	
刚性Solid	柔性Fine Stranded	带冷压头Furrule
0.5-25	0.5-16	0.5-16
20-4	20-4	20-4
V0		
18		

技术参数Technical Parameter		
厚度Thickness	宽度Width	高度Height
3.5	65.2	30.5
IEC	UL	
*	*	
*	*	
刚性Solid	柔性Fine Stranded	带冷压头Furrule
0.2-1.5	0.2-1.5	0.2-1.5
26-14	26-14	26-14
V0		
8-9		

技术参数Technical Parameter		
厚度Thickness	宽度Width	高度Height
5.2	72.2	35.3
IEC	UL	
*	*	
*	*	
刚性Solid	柔性Fine Stranded	带冷压头Furrule
0.2-4	0.2-2.5	0.2-2.5
26-12	26-12	26-12
V0		
8-10		

技术参数Technical Parameter		
厚度Thickness	宽度Width	高度Height
6.2	77.7	35.5
IEC	UL	
*	*	
*	*	
刚性Solid	柔性Fine Stranded	带冷压头Furrule
0.2-6	0.2-4	0.2-4
26-10	26-10	24-10
V0		
10-12		

产品信息Order Information	
产品Product	颜色Colour
适配NS 35/7.5导轨 Can Be Used For DIN Rail NS 35/7.5	黄Yellow green
*	*
*	*

订货信息Order Information	
订货号Order NO.	
TP10-3-PE	
*	
*	

订货信息Order Information	
订货号Order NO.	
TP16-3-PE	
*	
*	

订货信息Order Information	
订货号Order NO.	
TP1.5-4-PE	
*	
*	

订货信息Order Information	
订货号Order NO.	
TP2.5-4-PE	
*	
*	

订货信息Order Information	
订货号Order NO.	
TP4-4-PE	
*	
*	

配套附件Accessory	
端板Cover Plate	灰Gray
厚度2.2mm Thickness2.2mm	橙Orange
	蓝Blue
补偿端板Compensatory Plate	灰Gray
厚度1.00mm Thickness1.00mm	
跨接件Jumper	
位数Poles No.	颜色Colour
2	黄Yellow
3	黄Yellow
4	黄Yellow
...
9	黄Yellow
10	黄Yellow
正面标记Front Marker	
10位PCS	
正面标记和侧面标记Front And Side Marker	
可提供印字服务Printing Service	

配套附件Accessory	
订货号Order NO.	
TP10-3-GY-EA	
TP10-3-OG-EA	
TP10-3-BU-EA	
*	
*	
*	
*	
*	
*	
*	
*	
*	
*	
*	
*	
*	
*	
*	
*	
*	

配套附件Accessory	
订货号Order NO.	
TP16-3-GY-EA	
TP16-3-OG-EA	
TP16-3-BU-EA	
*	
*	
*	
*	
*	
*	
*	
*	
*	
*	
*	
*	
*	
*	
*	
*	

配套附件Accessory	
订货号Order NO.	
TP1.5-4-GY-EA	
TP1.5-4-OG-EA	
TP1.5-4-BU-EA	
*	
*	
*	
*	
*	
*	
*	
*	
*	
*	
*	
*	
*	
*	
*	

配套附件Accessory	
订货号Order NO.	
TC1.5-4-GY-EA	
TC1.5-4-OG-EA	
TC1.5-4-BU-EA	
*	
*	
*	
*	
*	
*	
*	
*	
*	
*	
*	
*	
*	
*	
*	

配套附件Accessory	
订货号Order NO.	
TP4-4-GY-EA	
TP4-4-OG-EA	
TP4-4-BU-EA	
*	
*	
*	
*	
*	
*	
*	
*	
*	
*	
*	
*	
*	
*	
*	

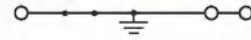
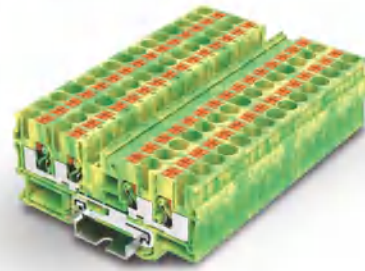

6mm² 两进两出接地端子
2-2 Feed Through Ground Terminal Block

尺寸Size		技术参数Technical Parameter		
注: 安装NS35/7.5导轨后的高度 Note: Height With DIN Rail NS 35/7.5	[mm]	8.2	91	42.2
额定参数Rated Parameters				
额定电压Rated Voltage	[V]	*	*	
额定电流Rated Current	[A]	*	*	
接线容量Wire Range				
	[mm ²]	0.5-10	0.5-6	0.5-6
	[AWG]	20-8	20-8	20-8
其余参数Other Parameters				
绝缘材料/阻燃等级, 符合UL94 Insulating Material / Flame Retardant Grade, Conforming To UL94		V0		
剥线长度Strip length	[mm]	10-12		
订货信息Order Information		订货信息Order Information		
产品Product	颜色Colour	订货号Order NO.		
适配NS 35/7.5导轨 Can Be Used For DIN Rail NS 35/7.5	黄Yellow green	TP6-4-PE		
	*	*		
	*	*		
配套附件Accessory		配套附件Accessory		
端板Cover Plate		订货号Order NO.		
	灰Gray	TP6-4-GY-EA		
厚度2.2mm Thickness2.2mm	橙Orange	TP6-4-OG-EA		
	蓝Blue	TP6-4-BU-EA		
补偿端板Compensatory Plate		订货号Order NO.		
厚度1.00mm Thickness1.00mm	灰Gray	*		
跨接件Jumper		订货号Order NO.		
位数Poles No.	颜色Colour	位数Poles No.	颜色Colour	
2	黄Yellow	2	黄Yellow	
3	黄Yellow	3	黄Yellow	
4	黄Yellow	4	黄Yellow	
...	
9	黄Yellow	9	黄Yellow	
10	黄Yellow	10	黄Yellow	
正面标记Front Marker	订货号Order NO.	正面标记Front Marker	订货号Order NO.	
10位PCS	308801	10位PCS	308801	
正面标记和侧面标记Front And Side Marker	订货号Order NO.	正面标记和侧面标记Front And Side Marker	订货号Order NO.	
可提供印字服务Printing Service	TMB8.2-50	可提供印字服务Printing Service	TMB8.2-50	



2.5mm² 斜面一进一出接线端子
1-1 Feed Through Angled Terminal Block

技术参数Technical Parameter			技术参数Technical Parameter		
厚度Thickness	宽度Width	高度Height	厚度Thickness	宽度Width	高度Height
5.2	50.9	41.4	5.2	50.9	41.4
IEC	UL		IEC	UL	
800	600		800	600	
24	20		24	20	
刚性Solid	柔性Fine Stranded	带冷压头Furrule	刚性Solid	柔性Fine Stranded	带冷压头Furrule
0.2-4	0.2-2.5	0.2-2.5	0.2-4	0.2-2.5	0.2-2.5
26-12	26-14	26-14	26-12	26-14	26-14
	V0			V0	
	8-10			8-10	
订货信息Order Information			订货信息Order Information		
订货号Order NO.			订货号Order NO.		
TPS2.5-2-GY			TPS2.5-3-GY		
TPS2.5-2-OG			TPS2.5-3-OG		
TPS2.5-2-BU			TPS2.5-3-BU		
配套附件Accessory			配套附件Accessory		
订货号Order NO.			订货号Order NO.		
TPS2.5-2-GY-EA			TPS2.5-2-GY-EA		
TPS2.5-2-OG-EA			TPS2.5-2-OG-EA		
TPS2.5-2-BU-EA			TPS2.5-2-BU-EA		
订货号Order NO.			订货号Order NO.		
*			*		
订货号Order NO.			订货号Order NO.		
TJA5.2-2			TJA5.2-2		
TJA5.2-3			TJA5.2-3		
TJA5.2-4			TJA5.2-4		
.....				
TJA5.2-9			TJA5.2-9		
TJA5.2-10			TJA5.2-10		
订货号Order NO.			订货号Order NO.		
305801或TMB5.2-120			305801或TMB5.2-120		
订货号Order NO.			订货号Order NO.		
*			*		



2.5mm² 斜面一进二出接线端子
1-2 Feed Through Angled Terminal Block

技术参数Technical Parameter			技术参数Technical Parameter		
厚度Thickness	宽度Width	高度Height	厚度Thickness	宽度Width	高度Height
5.2	50.9	41.4	5.2	50.9	41.4
IEC	UL		IEC	UL	
800	600		800	600	
24	20		24	20	
刚性Solid	柔性Fine Stranded	带冷压头Furrule	刚性Solid	柔性Fine Stranded	带冷压头Furrule
0.2-4	0.2-2.5	0.2-2.5	0.2-4	0.2-2.5	0.2-2.5
26-12	26-14	26-14	26-12	26-14	26-14
	V0			V0	
	8-10			8-10	
订货信息Order Information			订货信息Order Information		
订货号Order NO.			订货号Order NO.		
TPS2.5-3-GY			TPS2.5-4-GY		
TPS2.5-3-OG			TPS2.5-4-OG		
TPS2.5-3-BU			TPS2.5-4-BU		
配套附件Accessory			配套附件Accessory		
订货号Order NO.			订货号Order NO.		
TPS2.5-3-GY-EA			TPS2.5-3-GY-EA		
TPS2.5-3-OG-EA			TPS2.5-3-OG-EA		
TPS2.5-3-BU-EA			TPS2.5-3-BU-EA		
订货号Order NO.			订货号Order NO.		
*			*		
订货号Order NO.			订货号Order NO.		
TJA5.2-2			TJA5.2-2		
TJA5.2-3			TJA5.2-3		
TJA5.2-4			TJA5.2-4		
.....				
TJA5.2-9			TJA5.2-9		
TJA5.2-10			TJA5.2-10		
订货号Order NO.			订货号Order NO.		
305801或TMB5.2-120			305801或TMB5.2-120		
订货号Order NO.			订货号Order NO.		
*			*		



2.5mm² 斜面二进二出接线端子
2-2 Feed Through Angled Terminal Block

技术参数Technical Parameter			技术参数Technical Parameter		
厚度Thickness	宽度Width	高度Height	厚度Thickness	宽度Width	高度Height
5.2	50.9	41.4	5.2	50.9	41.4
IEC	UL		IEC	UL	
800	600		800	600	
24	20		24	20	
刚性Solid	柔性Fine Stranded	带冷压头Furrule	刚性Solid	柔性Fine Stranded	带冷压头Furrule
0.2-4	0.2-2.5	0.2-2.5	0.2-4	0.2-2.5	0.2-2.5
26-12	26-14	26-14	26-12	26-14	26-14
	V0			V0	
	8-10			8-10	
订货信息Order Information			订货信息Order Information		
订货号Order NO.			订货号Order NO.		
TPS2.5-4-GY			TPS2.5-4-GY		
TPS2.5-4-OG			TPS2.5-4-OG		
TPS2.5-4-BU			TPS2.5-4-BU		
配套附件Accessory			配套附件Accessory		
订货号Order NO.			订货号Order NO.		
TPS2.5-4-GY-EA			TPS2.5-4-GY-EA		
TPS2.5-4-OG-EA			TPS2.5-4-OG-EA		
TPS2.5-4-BU-EA			TPS2.5-4-BU-EA		
订货号Order NO.			订货号Order NO.		
*			*		
订货号Order NO.			订货号Order NO.		
TJA5.2-2			TJA5.2-2		
TJA5.2-3			TJA5.2-3		
TJA5.2-4			TJA5.2-4		
.....				
TJA5.2-9			TJA5.2-9		
TJA5.2-10			TJA5.2-10		
订货号Order NO.			订货号Order NO.		
305801或TMB5.2-120			305801或TMB5.2-120		
订货号Order NO.			订货号Order NO.		
*			*		

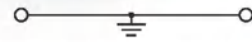

2.5mm² 斜面一进一接地端子
1-1 Feed Through Angled Ground Terminal Block

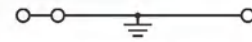

2.5mm² 斜面一进二出接地端子
1-2 Feed Through Angled Ground Terminal Block

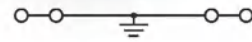
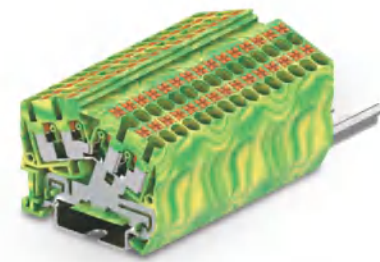

2.5mm² 斜面二进二出接地端子
2-2 Feed Through Angled Ground Terminal Block

尺寸Size	
注: 安装NS35/7.5导轨后的高度 Note: Height With DIN Rail NS 35/7.5	[mm]
额定参数Rated Parameters	
额定电压Rated Voltage	[V]
额定电流Rated Current	[A]
接线容量Wire Range	
	[mm ²]
	[AWG]
其他参数Other Parameters	
绝缘材料/阻燃等级, 符合UL94 Insulating Material / Flame Retardant Grade, Conforming To UL94	
剥线长度Strip length	[mm]
产品Product	
颜色Colour	黄绿Yellow green
适配NS 35/7.5导轨 Can Be Used For DIN Rail NS 35/7.5	
端板Cover Plate	
厚度2.2mm Thickness2.2mm	灰Gray 橙Orange 蓝Blue
补偿端板Compensatory Plate	
厚度1.00mm Thickness1.00mm	灰Gray
跨接件Jumper	
位数Poles No.	颜色Colour
2	黄Yellow
3	黄Yellow
4	黄Yellow
...
9	黄Yellow
10	黄Yellow
正面标记Front Marker	
10位PCS	
正面标记和侧面标记Front And Side Marker	
可提供印字服务Printing Service	

技术参数Technical Parameter		
厚度Thickness	宽度Width	高度Height
5.2	50.9	41.4
IEC	UL	
*	*	
*	*	
刚性Solid	柔性Fine Stranded	带冷压头Furrule
0.2-4	0.2-2.5	0.2-2.5
26-12	26-14	26-14
订货信息Order Information		
订货号Order NO.		
TPS2.5-2-PE		
*		
*		
配套附件Accessory		
订货号Order NO.		
TPS2.5-2-GY-EA		
TPS2.5-2-OG-EA		
TPS2.5-2-BU-EA		
订货号Order NO.		
*		
跨接件Jumper		
订货号Order NO.		
*		
*		
*		
.....		
*		
*		
正面标记Front Marker		
订货号Order NO.		
305801或TMB5.2-120		
正面标记和侧面标记Front And Side Marker		
订货号Order NO.		
*		

技术参数Technical Parameter		
厚度Thickness	宽度Width	高度Height
5.2	50.9	41.4
IEC	UL	
*	*	
*	*	
刚性Solid	柔性Fine Stranded	带冷压头Furrule
0.2-4	0.2-2.5	0.2-2.5
26-12	26-14	26-14
订货信息Order Information		
订货号Order NO.		
TPS2.5-3-PE		
*		
*		
配套附件Accessory		
订货号Order NO.		
TPS2.5-2-GY-EA		
TPS2.5-2-OG-EA		
TPS2.5-2-BU-EA		
订货号Order NO.		
*		
跨接件Jumper		
订货号Order NO.		
*		
*		
*		
.....		
*		
*		
正面标记Front Marker		
订货号Order NO.		
305801或TMB5.2-120		
正面标记和侧面标记Front And Side Marker		
订货号Order NO.		
*		

技术参数Technical Parameter		
厚度Thickness	宽度Width	高度Height
5.2	50.9	41.4
IEC	UL	
*	*	
*	*	
刚性Solid	柔性Fine Stranded	带冷压头Furrule
0.2-4	0.2-2.5	0.2-2.5
26-12	26-14	26-14
订货信息Order Information		
订货号Order NO.		
TPS2.5-4-PE		
*		
*		
配套附件Accessory		
订货号Order NO.		
TPS2.5-2-GY-EA		
TPS2.5-2-OG-EA		
TPS2.5-2-BU-EA		
订货号Order NO.		
*		
跨接件Jumper		
订货号Order NO.		
*		
*		
*		
.....		
*		
*		
正面标记Front Marker		
订货号Order NO.		
305801或TMB5.2-120		
正面标记和侧面标记Front And Side Marker		
订货号Order NO.		
*		

技术参数Technical Parameter		
厚度Thickness	宽度Width	高度Height
5.2	50.9	41.4
IEC	UL	
*	*	
*	*	
刚性Solid	柔性Fine Stranded	带冷压头Furrule
0.2-4	0.2-2.5	0.2-2.5
26-12	26-14	26-14
订货信息Order Information		
订货号Order NO.		
TPS2.5-4-PE		
*		
*		
配套附件Accessory		
订货号Order NO.		
TPS2.5-2-GY-EA		
TPS2.5-2-OG-EA		
TPS2.5-2-BU-EA		
订货号Order NO.		
*		
跨接件Jumper		
订货号Order NO.		
*		
*		
*		
.....		
*		
*		
正面标记Front Marker		
订货号Order NO.		
305801或TMB5.2-120		
正面标记和侧面标记Front And Side Marker		
订货号Order NO.		
*		

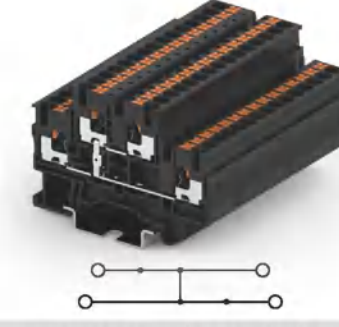
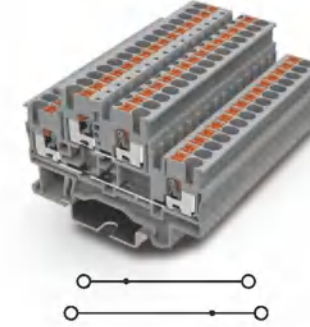
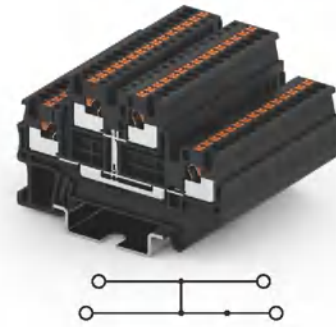
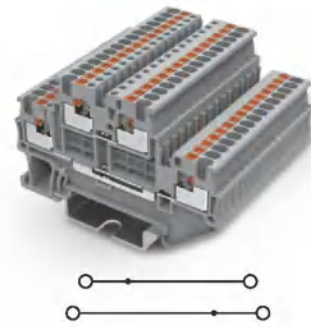

		1.5mm ² 双层接线端子 Double Level Terminal Block			1.5mm ² 双层等电位接线端子 Double Level Terminal Block			
		技术参数Technical Parameter			技术参数Technical Parameter			
尺寸Size		厚度Thickness	宽度Width	高度Height	厚度Thickness	宽度Width	高度Height	
注: 安装NS35/7.5导轨后的高度 Note: Height With DIN Rail NS 35/7.5		[mm]	3.5	65.4	41.1	3.5	65.4	41.1
额定参数Rated Parameters		IEC	UL		IEC	UL		
额定电压Rated Voltage		[V]	500	600	500	600		
额定电流Rated Current		[A]	16	15	16	15		
接线容量Wire Range		刚性Solid	柔性Fine Stranded	带冷压头Furrule	刚性Solid	柔性Fine Stranded	带冷压头Furrule	
[mm ²]		0.2-1.5	0.2-1.5	0.2-1.5	0.2-1.5	0.2-1.5	0.2-1.5	
[AWG]		26-14	26-14	26-14	26-14	26-14	26-14	
其余参数Other Parameters		V0			V0			
绝缘材料/阻燃等级, 符合UL94 Insulating Material / Flame Retardant Grade, Conforming To UL94		8-9			8-9			
剥线长度Strip length		[mm]			8-9			
产品Product		颜色Colour			订货信息Order Information			
适配NS 35/7.5导轨 Can Be Used For DIN Rail NS 35/7.5		灰Gray	订货号Order NO.		订货号Order NO.			
		橙Orange	TPD1.5-2-GY		TPD1.5-2-PV(黑色)			
		蓝Blue	TPD1.5-2-OG		*			
			TPD1.5-2-BU		*			
端板Cover Plate		配套附件Accessory			配套附件Accessory			
厚度2.2mm Thickness2.2mm		灰Gray	订货号Order NO.		订货号Order NO.			
		橙Orange	TPD1.5-2-GY-EA		TPD1.5-2-GY-EA			
		蓝Blue	TPD1.5-2-OG-EA		TPD1.5-2-OG-EA			
			TPD1.5-2-BU-EA		TPD1.5-2-BU-EA			
补偿端板Compensatory Plate		订货号Order NO.			订货号Order NO.			
厚度1.00mm Thickness1.00mm		灰Gray	*		*			
跨接件Jumper		订货号Order NO.			订货号Order NO.			
位数Poles No.		颜色Colour	订货号Order NO.		订货号Order NO.			
2		黄Yellow	TJA3.5-2		TJA3.5-2			
3		黄Yellow	TJA3.5-3		TJA3.5-3			
4		黄Yellow	TJA3.5-4		TJA3.5-4			
...				
9		黄Yellow	TJA3.5-9		TJA3.5-9			
10		黄Yellow	TJA3.5-10		TJA3.5-10			
正面标记Front Marker		订货号Order NO.			订货号Order NO.			
10位PCS			*		*			
正面标记和侧面标记Front And Side Marker		订货号Order NO.			订货号Order NO.			
可提供印字服务Printing Service			TMB3.5-100		TMB3.5-100			

		2.5mm ² 双层接线端子 Double Level Terminal Block			2.5mm ² 双层等电位接线端子 Double Level With Equipotential Bonder Terminal Block			
		技术参数Technical Parameter			技术参数Technical Parameter			
尺寸Size		厚度Thickness	宽度Width	高度Height	厚度Thickness	宽度Width	高度Height	
注: 安装NS35/7.5导轨后的高度 Note: Height With DIN Rail NS 35/7.5		[mm]	5.2	68.2	45.8	5.2	68.2	45.8
额定参数Rated Parameters		IEC	UL		IEC	UL		
额定电压Rated Voltage		[V]	500	600	500	600		
额定电流Rated Current		[A]	22	20	22	20		
接线容量Wire Range		刚性Solid	柔性Fine Stranded	带冷压头Furrule	刚性Solid	柔性Fine Stranded	带冷压头Furrule	
[mm ²]		0.2-4	0.2-2.5	0.2-2.5	0.2-4	0.2-2.5	0.2-2.5	
[AWG]		26-12	26-14	26-14	26-12	26-14	26-14	
其余参数Other Parameters		V0			V0			
绝缘材料/阻燃等级, 符合UL94 Insulating Material / Flame Retardant Grade, Conforming To UL94		8-10			8-10			
剥线长度Strip length		[mm]			8-10			
产品Product		颜色Colour			订货信息Order Information			
适配NS 35/7.5导轨 Can Be Used For DIN Rail NS 35/7.5		灰Gray	订货号Order NO.		订货号Order NO.			
		橙Orange	TPD2.5-2-GY		TPD2.5-2-PV (黑色)			
		蓝Blue	TPD2.5-2-OG		*			
			TPD2.5-2-BU		*			
端板Cover Plate		配套附件Accessory			配套附件Accessory			
厚度2.2mm Thickness2.2mm		灰Gray	订货号Order NO.		订货号Order NO.			
		橙Orange	TPD2.5-2-GY-EA		TPD2.5-2-GY-EA			
		蓝Blue	TPD2.5-2-OG-EA		TPD2.5-2-OG-EA			
			TPD2.5-2-BU-EA		TPD2.5-2-BU-EA			
补偿端板Compensatory Plate		订货号Order NO.			订货号Order NO.			
厚度1.00mm Thickness1.00mm		灰Gray	*		*			
跨接件Jumper		订货号Order NO.			订货号Order NO.			
位数Poles No.		颜色Colour	订货号Order NO.		订货号Order NO.			
2		黄Yellow	TJA5.2-2		TJA5.2-2			
3		黄Yellow	TJA5.2-3		TJA5.2-3			
4		黄Yellow	TJA5.2-4		TJA5.2-4			
...				
9		黄Yellow	TJA5.2-9		TJA5.2-9			
10		黄Yellow	TJA5.2-10		TJA5.2-10			
正面标记Front Marker		订货号Order NO.			订货号Order NO.			
10位PCS			*		*			
正面标记和侧面标记Front And Side Marker		订货号Order NO.			订货号Order NO.			
可提供印字服务Printing Service			TMB5.2-120		TMB5.2-120			

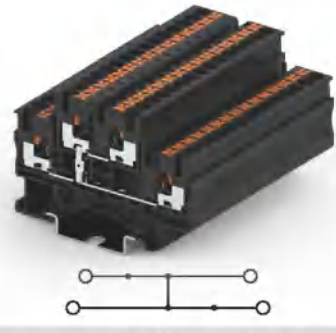
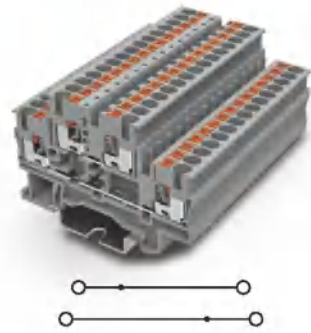

4mm² 双层接线端子
Double Level Terminal Block

4mm² 双层等电位接线端子
Double Level With Equipotential Bonding Terminal Block

尺寸Size	
注: 安装NS35/7.5导轨后的高度 Note: Height With DIN Rail NS 35/7.5	[mm]
额定电压Rated Voltage	[V]
额定电流Rated Current	[A]
接线容量Wire Range	
	[mm ²]
	[AWG]
其余参数Other Parameters	
绝缘材料/阻燃等级, 符合UL94 Insulating Material / Flame Retardant Grade, Conforming To UL94	
剥线长度Strip length	[mm]

技术参数Technical Parameter		
厚度Thickness	宽度Width	高度Height
6.2	84	46.2
IEC	UL	
500	600	
28	28	
接线容量Wire Range		
刚性Solid	柔性Fine Stranded	带冷压头Furrule
0.2-6	0.2-4	0.2-4
24-10	24-10	24-10
其余参数Other Parameters		
	V0	
	12	

技术参数Technical Parameter		
厚度Thickness	宽度Width	高度Height
6.2	84	46.2
IEC	UL	
500	600	
28	28	
接线容量Wire Range		
刚性Solid	柔性Fine Stranded	带冷压头Furrule
0.2-6	0.2-4	0.2-4
24-10	24-10	24-10
其余参数Other Parameters		
	V0	
	12	

产品信息Order Information	
产品Product	颜色Colour
适配NS 35/7.5导轨 Can Be Used For DIN Rail NS 35/7.5	灰Gray 橙Orange 蓝Blue

产品信息Order Information	
订货号Order NO.	TPD4-2-GY TPD4-2-OG TPD4-2-BU

产品信息Order Information	
订货号Order NO.	TPD4-2-PV(黑色)

配套附件Accessory	
端板Cover Plate	厚度2.2mm Thickness2.2mm
	灰Gray 橙Orange 蓝Blue

配套附件Accessory	
订货号Order NO.	TPD4-2-GY-EA TPD4-2-OG-EA TPD4-2-BU-EA

配套附件Accessory	
订货号Order NO.	TPD4-2-GY-EA TPD4-2-OG-EA TPD4-2-BU-EA

补偿端板Compensatory Plate	
厚度1.00mm Thickness1.00mm	灰Gray

补偿端板Compensatory Plate	
订货号Order NO.	*

补偿端板Compensatory Plate	
订货号Order NO.	*

跨接件Jumper	
位数Poles No.	颜色Colour
2	黄Yellow
3	黄Yellow
4	黄Yellow
...
9	黄Yellow
10	黄Yellow

跨接件Jumper	
订货号Order NO.	TJA6.2-2 TJA6.2-3 TJA6.2-4 TJA6.2-9 TJA6.2-10

跨接件Jumper	
订货号Order NO.	TJA6.2-2 TJA6.2-3 TJA6.2-4 TJA6.2-9 TJA6.2-10

正面标记Front Marker	
5PCS一条	*
正面标记Lightning Marker	
10PCS一条	306801
正面标记和侧面标记Front And Side Marker	
可提供印字服务Printing Service	TMB6.2-100

正面标记Front Marker	
订货号Order NO.	*
订货号Order NO.	306801
订货号Order NO.	TMB6.2-100

正面标记Front Marker	
订货号Order NO.	*
订货号Order NO.	306801
订货号Order NO.	TMB6.2-100

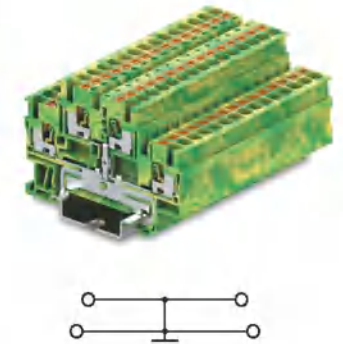
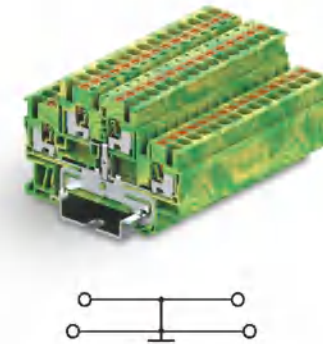
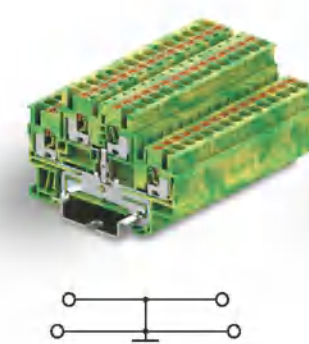

1.5mm² 双层接地端子
Double Level Ground Terminal Block

2.5mm² 双层接地端子
Double Level Ground Terminal Block

4mm² 双层接地端子
Double Level Ground Terminal Block

尺寸Size	
注: 安装NS35/7.5导轨后的高度 Note: Height With DIN Rail NS 35/7.5	[mm]
额定电压Rated Voltage	[V]
额定电流Rated Current	[A]
接线容量Wire Range	
	[mm ²]
	[AWG]
其余参数Other Parameters	
绝缘材料/阻燃等级, 符合UL94 Insulating Material / Flame Retardant Grade, Conforming To UL94	
剥线长度Strip length	[mm]

技术参数Technical Parameter		
厚度Thickness	宽度Width	高度Height
3.5	65.4	41.1
IEC	UL	
*	*	
*	*	
接线容量Wire Range		
刚性Solid	柔性Fine Stranded	带冷压头Furrule
0.2-1.5	0.2-1.5	0.2-1.5
26-14	26-14	26-14
其余参数Other Parameters		
	V0	
	8-9	

技术参数Technical Parameter		
厚度Thickness	宽度Width	高度Height
5.2	68.2	45.8
IEC	UL	
*	*	
*	*	
接线容量Wire Range		
刚性Solid	柔性Fine Stranded	带冷压头Furrule
0.2-4	0.2-2.5	0.2-2.5
26-12	26-14	26-14
其余参数Other Parameters		
	V0	
	8-10	

技术参数Technical Parameter		
厚度Thickness	宽度Width	高度Height
6.2	84	46.2
IEC	UL	
*	*	
*	*	
接线容量Wire Range		
刚性Solid	柔性Fine Stranded	带冷压头Furrule
0.2-6	0.2-4	0.2-4
24-10	24-10	24-10
其余参数Other Parameters		
	V0	
	12	

产品信息Order Information	
产品Product	颜色Colour
适配NS 35/7.5导轨 Can Be Used For DIN Rail NS 35/7.5	黄Yellow green * *

产品信息Order Information	
订货号Order NO.	TPD1.5-2-PE * *

产品信息Order Information	
订货号Order NO.	TPD2.5-2-PE * *

产品信息Order Information	
订货号Order NO.	TPD4-2-PE * *

配套附件Accessory	
端板Cover Plate	厚度2.2mm Thickness2.2mm
	灰Gray 橙Orange 蓝Blue

配套附件Accessory	
订货号Order NO.	TPD1.5-2-GY-EA TPD1.5-2-OG-EA TPD1.5-2-BU-EA

配套附件Accessory	
订货号Order NO.	TPD2.5-2-GY-EA TPD2.5-2-OG-EA TPD2.5-2-BU-EA

配套附件Accessory	
订货号Order NO.	TPD4-2-GY-EA TPD4-2-OG-EA TPD4-2-BU-EA

补偿端板Compensatory Plate	
厚度1.00mm Thickness1.00mm	灰Gray

补偿端板Compensatory Plate	
订货号Order NO.	*

补偿端板Compensatory Plate	
订货号Order NO.	*

补偿端板Compensatory Plate	
订货号Order NO.	*

跨接件Jumper	
位数Poles No.	颜色Colour
2	黄Yellow
3	黄Yellow
4	黄Yellow
...
9	黄Yellow
10	黄Yellow

跨接件Jumper	
订货号Order NO.	TJA3.5-2 TJA3.5-3 TJA3.5-4 TJA3.5-9 TJA3.5-10

跨接件Jumper	
订货号Order NO.	TJA5.2-2 TJA5.2-3 TJA5.2-4 TJA5.2-9 TJA5.2-10

跨接件Jumper	
订货号Order NO.	TJA6.2-2 TJA6.2-3 TJA6.2-4 TJA6.2-9 TJA6.2-10

正面标记Front Marker	
10位PCS	*
正面标记和侧面标记Front And Side Marker	
可提供印字服务Printing Service	*

正面标记Front Marker	
订货号Order NO.	*
订货号Order NO.	*
订货号Order NO.	TMB3.5-100

正面标记Front Marker	
订货号Order NO.	*
订货号Order NO.	*
订货号Order NO.	TMB5.2-120

正面标记Front Marker	
订货号Order NO.	*
订货号Order NO.	306801
订货号Order NO.	TMB6.2-100



斜面双层八线接线端子
Double level angled type terminal block 8-wire

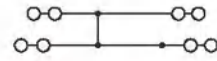

斜面双层八线等电位接线端子
Double level angled type terminal block with equipotential bonder 8-wire

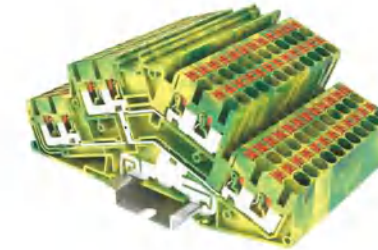

斜面双层八线接地端子
Double level angled type ground terminal block 8-wire

尺寸Size	
注: 安装NS35/7.5导轨后的高度 Note: Height With DIN Rail NS 35/7.5	[mm]
额定参数Rated Parameters	
额定电压Rated Voltage	[V]
额定电流Rated Current	[A]
接线容量Wire Range	
	[mm ²]
	[AWG]
其余参数Other Parameters	
绝缘材料/阻燃等级, 符合UL94 Insulating Material / Flame Retardant Grade, Conforming To UL94	
剥线长度Strip length	[mm]

技术参数Technical Parameter		
厚度Thickness	宽度Width	高度Height
5.2	115.2	53
IEC	UL	
800	*	
20	*	
刚性Solid	柔性Fine Stranded	带冷压头Furrule
0.2-4.0	0.2-2.5	0.2-2.5
26-12	26-12	26-12
V0		
8-10		

技术参数Technical Parameter		
厚度Thickness	宽度Width	高度Height
5.2	115.2	53
IEC	UL	
800	*	
20	*	
刚性Solid	柔性Fine Stranded	带冷压头Furrule
0.2-4.0	0.2-2.5	0.2-2.5
26-12	26-12	26-12
V0		
8-10		

尺寸Size	
注: 安装NS35/7.5导轨后的高度 Note: Height With DIN Rail NS 35/7.5	[mm]
额定参数Rated Parameters	
额定电压Rated Voltage	[V]
额定电流Rated Current	[A]
接线容量Wire Range	
	[mm ²]
	[AWG]
其余参数Other Parameters	
绝缘材料/阻燃等级, 符合UL94 Insulating Material / Flame Retardant Grade, Conforming To UL94	
剥线长度Strip length	[mm]

技术参数Technical Parameter		
厚度Thickness	宽度Width	高度Height
5.2	115.2	53
IEC	UL	
800	*	
20	*	
刚性Solid	柔性Fine Stranded	带冷压头Furrule
0.2-4.0	0.2-2.5	0.2-2.5
26-12	26-12	26-12
V0		
8-10		

产品Product		颜色Colour		
适配NS 35/7.5导轨 Can Be Used For DIN Rail NS 35/7.5	灰Gray	橙Orange	蓝Blue	
盖板Cover Plate		灰Gray	橙Orange	蓝Blue
厚度2.2mm Thickness2.2mm				
补偿盖板Compensatory Plate		灰Gray		
厚度1.00mm Thickness1.00mm				
跨接件Jumper				
位数Poles No.	颜色Colour			
2	黄Yellow			
3	黄Yellow			
4	黄Yellow			
...	...			
9	黄Yellow			
10	黄Yellow			
闪电标记Front Marker				
5PCS一条	*			
正面标记Lightning Marker				
10PCS一条	*			
正面标记和侧面标记Front And Side Marker				
可提供印字服务Printing Service	TMB5.2-120			

订货信息Order Information			
订货号Order NO.	TPDS2.5-4-GY	TPDS2.5-4-OG	TPDS2.5-4-BU
配套附件Accessory			
订货号Order NO.	TPDS2.5-4-GY-EC	TPDS2.5-4-OG-EC	*
订货号Order NO.	*	*	*
订货号Order NO.	TJA5.2-2	TJA5.2-3	TJA5.2-4

	TJA5.2-9	TJA5.2-10	
订货号Order NO.	*	*	*
订货号Order NO.	*	*	*
订货号Order NO.	TMB5.2-120		

订货信息Order Information			
订货号Order NO.	TPDS2.5-4-PV(黑色)		
配套附件Accessory			
订货号Order NO.	TPDS2.5-4-GY-EC	TPDS2.5-4-OG-EC	*
订货号Order NO.	*	*	*
订货号Order NO.	TJA5.2-2	TJA5.2-3	TJA5.2-4

	TJA5.2-9	TJA5.2-10	
订货号Order NO.	*	*	*
订货号Order NO.	*	*	*
订货号Order NO.	TMB5.2-120		

产品Product		颜色Colour		
适配NS 35/7.5导轨 Can Be Used For DIN Rail NS 35/7.5	灰Gray	橙Orange	蓝Blue	
盖板Cover Plate		灰Gray	橙Orange	蓝Blue
厚度2.2mm Thickness2.2mm				
补偿盖板Compensatory Plate		灰Gray		
厚度1.00mm Thickness1.00mm				
跨接件Jumper				
位数Poles No.	颜色Colour			
2	黄Yellow			
3	黄Yellow			
4	黄Yellow			
...	...			
9	黄Yellow			
10	黄Yellow			
闪电标记Front Marker				
5PCS一条	*			
正面标记Lightning Marker				
10PCS一条	*			
正面标记和侧面标记Front And Side Marker				
可提供印字服务Printing Service	TMB5.2-120			

订货信息Order Information			
订货号Order NO.	TPDS2.5-4-PE		
配套附件Accessory			
订货号Order NO.	TPDS2.5-4-GY-EC	TPDS2.5-4-OG-EC	*
订货号Order NO.	*	*	*
订货号Order NO.	TJA5.2-2	TJA5.2-3	TJA5.2-4

	TJA5.2-9	TJA5.2-10	
订货号Order NO.	*	*	*
订货号Order NO.	*	*	*
订货号Order NO.	TMB5.2-120		



2.5mm² 三层接线端子
Triple Level Terminal Block



2.5mm² 三层等电位接线端子
Triple Level With Equipotential Bonding Terminal Block



2.5mm² 三层斜面接线端子
Triple level angled type terminal block

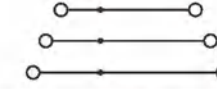

2.5mm² 三层斜面接线端子带支架
Triple level angled type terminal block with marker carrier

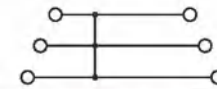

2.5mm² 三层斜面等电位接线端子
Triple level angled type terminal block with equipotential bonding

尺寸Size	
注: 安装NS35/7.5导轨后的高度 Note: Height With DIN Rail NS 35/7.5	[mm]
额定电压Rated Voltage	[V]
额定电流Rated Current	[A]
接线容量Wire Range	
	[mm ²]
	[AWG]
其余参数Other Parameters	
绝缘材料/阻燃等级, 符合UL94 Insulating Material / Flame Retardant Grade, Conforming To UL94	
剥线长度Strip length	[mm]
产品Product	
颜色Colour	灰Gray 橙Orange 蓝Blue
适配NS 35/7.5导轨 Can Be Used For DIN Rail NS 35/7.5	
端板Cover Plate	
厚度2.2mm Thickness2.2mm	灰Gray 橙Orange 蓝Blue
补偿端板Compensatory Plate	
厚度1.00mm Thickness1.00mm	灰Gray
跨接件Jumper	
位数Poles No.	颜色Colour
2	黄Yellow
3	黄Yellow
4	黄Yellow
...
9	黄Yellow
10	黄Yellow
正面标记Front Marker	
10位PCS	*
正面标记和侧面标记Front And Side Marker	
可提供印字服务Printing Service	TMB5.2-120

技术参数Technical Parameter		
厚度Thickness	宽度Width	高度Height
5.2	100.7	56.4
IEC	UL	
500	300	
20	20	
接线容量Wire Range		
刚性Solid	柔性Fine Stranded	带冷压头Furrule
0.2-4	0.2-2.5	0.2-2.5
26-12	26-12	26-12
其余参数Other Parameters		
绝缘材料/阻燃等级, 符合UL94 Insulating Material / Flame Retardant Grade, Conforming To UL94		
剥线长度Strip length [mm]		
8-10		
订货信息Order Information		
订货号Order NO.		
TPT2.5-2-GY		
TPT2.5-2-OG		
TPT2.5-2-BU		
配套附件Accessory		
订货号Order NO.		
TPT2.5-2-GY-EA		
TPT2.5-2-OG-EA		
TPT2.5-2-BU-EA		
订货号Order NO.		
*		
跨接件Jumper		
订货号Order NO.		
TJA5.2-2		
TJA5.2-3		
TJA5.2-4		
.....		
TJA5.2-9		
TJA5.2-10		
正面标记Front Marker		
订货号Order NO.		
*		
正面标记和侧面标记Front And Side Marker		
订货号Order NO.		
TMB5.2-120		

技术参数Technical Parameter		
厚度Thickness	宽度Width	高度Height
5.2	100.7	56.4
IEC	UL	
500	300	
20	20	
接线容量Wire Range		
刚性Solid	柔性Fine Stranded	带冷压头Furrule
0.2-4	0.2-2.5	0.2-2.5
26-12	26-12	26-12
其余参数Other Parameters		
绝缘材料/阻燃等级, 符合UL94 Insulating Material / Flame Retardant Grade, Conforming To UL94		
剥线长度Strip length [mm]		
8-10		
订货信息Order Information		
订货号Order NO.		
TPT2.5-2-PV(黑色)		
*		
*		
配套附件Accessory		
订货号Order NO.		
TPT2.5-2-GY-EA		
TPT2.5-2-OG-EA		
TPT2.5-2-BU-EA		
订货号Order NO.		
*		
跨接件Jumper		
订货号Order NO.		
TJA5.2-2		
TJA5.2-3		
TJA5.2-4		
.....		
TJA5.2-9		
TJA5.2-10		
正面标记Front Marker		
订货号Order NO.		
*		
正面标记和侧面标记Front And Side Marker		
订货号Order NO.		
TMB5.2-120		

技术参数Technical Parameter		
厚度Thickness	宽度Width	高度Height
5.2	89.4	91
IEC	UL	
800	600	
20	20	
接线容量Wire Range		
刚性Solid	柔性Fine Stranded	带冷压头Furrule
0.14-2.5	0.14-2.5	0.14-2.5
26-12	26-12	26-12
其余参数Other Parameters		
绝缘材料/阻燃等级, 符合UL94 Insulating Material / Flame Retardant Grade, Conforming To UL94		
剥线长度Strip length [mm]		
8-10		
订货信息Order Information		
订货号Order NO.		
TPTS2.5-2-GY		
TPTS2.5-2-OG		
TPTS2.5-2-BU		
配套附件Accessory		
订货号Order NO.		
TPTS2.5-2-GY-EC		
TPTS2.5-2-OG-EC		
订货号Order NO.		
*		
跨接件Jumper		
订货号Order NO.		
TJA5.2-2		
TJA5.2-3		
TJA5.2-4		
.....		
TJA5.2-9		
TJA5.2-10		
正面标记Front Marker		
订货号Order NO.		
*		
正面标记和侧面标记Front And Side Marker		
订货号Order NO.		
TMB5.2-120		

技术参数Technical Parameter		
厚度Thickness	宽度Width	高度Height
5.2	89.4	91
IEC	UL	
800	600	
20	20	
接线容量Wire Range		
刚性Solid	柔性Fine Stranded	带冷压头Furrule
0.14-2.5	0.14-2.5	0.14-2.5
26-12	26-12	26-12
其余参数Other Parameters		
绝缘材料/阻燃等级, 符合UL94 Insulating Material / Flame Retardant Grade, Conforming To UL94		
剥线长度Strip length [mm]		
8-10		
订货信息Order Information		
订货号Order NO.		
TPTS2.5-2T-GY		
TPTS2.5-2T-OG		
TPTS2.5-2T-BU		
配套附件Accessory		
订货号Order NO.		
TPTS2.5-2-GY-EC		
TPTS2.5-2-OG-EC		
订货号Order NO.		
*		
跨接件Jumper		
订货号Order NO.		
TJA5.2-2		
TJA5.2-3		
TJA5.2-4		
.....		
TJA5.2-9		
TJA5.2-10		
正面标记Front Marker		
订货号Order NO.		
*		
正面标记和侧面标记Front And Side Marker		
订货号Order NO.		
TMB5.2-120		

技术参数Technical Parameter		
厚度Thickness	宽度Width	高度Height
5.2	89.1	91
IEC	UL	
800	600	
20	20	
接线容量Wire Range		
刚性Solid	柔性Fine Stranded	带冷压头Furrule
0.14-2.5	0.14-2.5	0.14-2.5
26-12	26-12	26-12
其余参数Other Parameters		
绝缘材料/阻燃等级, 符合UL94 Insulating Material / Flame Retardant Grade, Conforming To UL94		
剥线长度Strip length [mm]		
8-10		
订货信息Order Information		
订货号Order NO.		
TPTS2.5-2-PV(黑色)		
*		
*		
配套附件Accessory		
订货号Order NO.		
TPTS2.5-2-GY-EC		
TPTS2.5-2-OG-EC		
订货号Order NO.		
*		
跨接件Jumper		
订货号Order NO.		
TJA5.2-2		
TJA5.2-3		
TJA5.2-4		
.....		
TJA5.2-9		
TJA5.2-10		
正面标记Front Marker		
订货号Order NO.		
*		
正面标记和侧面标记Front And Side Marker		
订货号Order NO.		
TMB5.2-120		

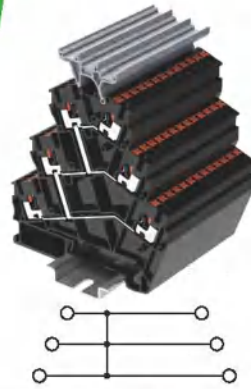

2.5mm² 三层斜面等电位接线端子带支架
Triple level angled type terminal block with equipotential bonder and marker carrier

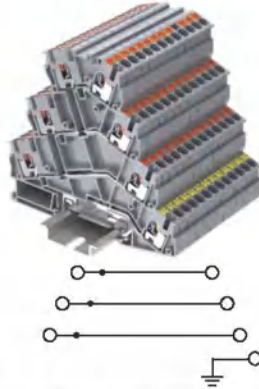

2.5mm² 四层斜面接线端子, 带PE支脚
Quadruple level angled type terminal block with grounding foot

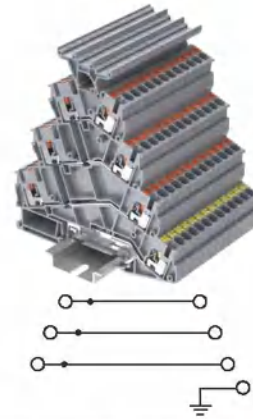

2.5mm² 四层斜面接线端子, 带PE支脚带支架
Quadruple level angled type terminal block with grounding foot and marker carrier

尺寸Size	
注: 安装NS35/7.5导轨后的高度 Note: Height With DIN Rail NS 35/7.5	[mm]
额定参数Rated Parameters	
额定电压Rated Voltage	[V]
额定电流Rated Current	[A]
接线容量Wire Range	
	[mm ²]
	[AWG]
其余参数Other Parameters	
绝缘材料/阻燃等级, 符合UL94 Insulating Material / Flame Retardant Grade, Conforming To UL94	
剥线长度Strip length	[mm]
产品Product	
颜色Colour	灰Gray
适配NS 35/7.5导轨 Can Be Used For DIN Rail NS 35/7.5	橙Orange
	蓝Blue
端板Cover Plate	
厚度2.2mm Thickness2.2mm	灰Gray
	橙Orange
	蓝Blue
补偿端板Compensatory Plate	
厚度1.00mm Thickness1.00mm	灰Gray
跨接件Jumper	
位数Poles No.	
	颜色Colour
2	黄Yellow
3	黄Yellow
4	黄Yellow
...	—
9	黄Yellow
10	黄Yellow
正面标记Front Marker	
10位PCS	*
正面标记和侧面标记Front And Side Marker	
可提供印字服务Printing Service	

技术参数Technical Parameter		
厚度Thickness	宽度Width	高度Height
5.2	89.4	91
IEC	UL	
800	600	
20	20	
刚性Solid		
0.14-2.5	0.14-2.5	0.14-2.5
柔性Fine Stranded		
26-12	26-12	26-12
带冷压头Furrule		
0.14-2.5	0.14-2.5	0.14-2.5
26-12	26-12	26-12
其余参数Other Parameters		
绝缘材料/阻燃等级, 符合UL94 Insulating Material / Flame Retardant Grade, Conforming To UL94		
剥线长度Strip length [mm]		
V0		
8-10		
订货信息Order Information		
订货号Order NO.		
TPTS2.5-2T-PV(黑色)		
*		
*		
配套附件Accessory		
订货号Order NO.		
TPTS2.5-2-GY-EC		
TPTS2.5-2-OG-EC		
订货号Order NO.		
*		
跨接件Jumper		
订货号Order NO.		
TJA5.2-2		
TJA5.2-3		
TJA5.2-4		
.....		
TJA5.2-9		
TJA5.2-10		
正面标记Front Marker		
订货号Order NO.		
*		
正面标记和侧面标记Front And Side Marker		
订货号Order NO.		
TMB5.2-120		

技术参数Technical Parameter		
厚度Thickness	宽度Width	高度Height
5.2	99.4	91
IEC	UL	
800	600	
20	20	
刚性Solid		
0.14-2.5	0.14-2.5	0.14-2.5
柔性Fine Stranded		
26-12	26-12	26-12
带冷压头Furrule		
0.14-2.5	0.14-2.5	0.14-2.5
26-12	26-12	26-12
其余参数Other Parameters		
绝缘材料/阻燃等级, 符合UL94 Insulating Material / Flame Retardant Grade, Conforming To UL94		
剥线长度Strip length [mm]		
V0		
8-10		
订货信息Order Information		
订货号Order NO.		
TPFS2.5-2-GY		
TPFS2.5-2-OG		
TPFS2.5-2-BU		
配套附件Accessory		
订货号Order NO.		
TPFS2.5-2-GY-EC		
TPFS2.5-2-OG-EC		
订货号Order NO.		
*		
跨接件Jumper		
订货号Order NO.		
TJA5.2-2		
TJA5.2-3		
TJA5.2-4		
.....		
TJA5.2-9		
TJA5.2-10		
正面标记Front Marker		
订货号Order NO.		
305801		
正面标记和侧面标记Front And Side Marker		
订货号Order NO.		
TMB5.2-120		

技术参数Technical Parameter		
厚度Thickness	宽度Width	高度Height
5.2	99.4	91
IEC	UL	
800	600	
20	20	
刚性Solid		
0.14-2.5	0.14-2.5	0.14-2.5
柔性Fine Stranded		
26-12	26-12	26-12
带冷压头Furrule		
0.14-2.5	0.14-2.5	0.14-2.5
26-12	26-12	26-12
其余参数Other Parameters		
绝缘材料/阻燃等级, 符合UL94 Insulating Material / Flame Retardant Grade, Conforming To UL94		
剥线长度Strip length [mm]		
V0		
8-10		
订货信息Order Information		
订货号Order NO.		
TPFS2.5-2T-GY		
TPFS2.5-2T-OG		
TPFS2.5-2T-BU		
配套附件Accessory		
订货号Order NO.		
TPFS2.5-2-GY-EC		
TPFS2.5-2-OG-EC		
订货号Order NO.		
*		
跨接件Jumper		
订货号Order NO.		
TJA5.2-2		
TJA5.2-3		
TJA5.2-4		
.....		
TJA5.2-9		
TJA5.2-10		
正面标记Front Marker		
订货号Order NO.		
305801		
正面标记和侧面标记Front And Side Marker		
订货号Order NO.		
*		

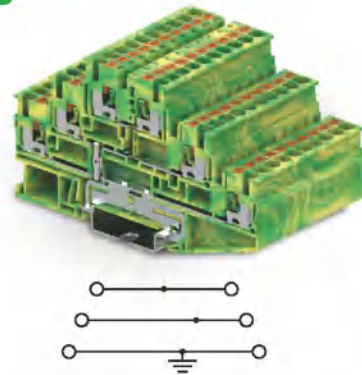

2.5mm² 三层接地端子
Triple Level Ground Terminal Block

技术参数Technical Parameter		
厚度Thickness	宽度Width	高度Height
5.2	100.7	56.4
IEC	UL	
*	*	
*	*	
接线容量Wire Range		
	刚性Solid	柔性Fine Stranded
	0.2-4	0.2-2.5
	26-12	26-12
		带冷压头Furrule
		0.2-2.5
		26-12
其余参数Other Parameters		
绝缘材料/阻燃等级, 符合UL94 Insulating Material / Flame Retardant Grade, Conforming To UL94		
	V0	
剥线长度Strip length	8-10	

订货信息Order Information

产品Product	颜色Colour	订货号Order NO.
适配NS 35/7.5导轨 Can Be Used For DIN Rail NS 35/7.5	黄绿Yellow green	TPT2.5-2-PL
		*
		*

配套附件Accessory

端板Cover Plate	订货号Order NO.
厚度2.2mm Thickness2.2mm	TPT2.5-2-GY-EA
	TPT2.5-2-OG-EA
	TPT2.5-2-BU-EA
补偿端板Compensatory Plate	订货号Order NO.
厚度1.00mm Thickness1.00mm	*
跨接件Jumper	订货号Order NO.
位数Poles No.	颜色Colour
2	黄Yellow
3	黄Yellow
4	黄Yellow
...
9	黄Yellow
10	黄Yellow
正面标记Front Marker	订货号Order NO.
10位PCS	*
正面标记和侧面标记Front And Side Marker	订货号Order NO.
可提供印字服务Printing Service	TMB5.2-120

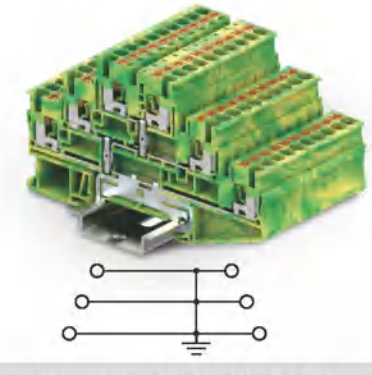

2.5mm² 三层等电位接地端子
Triple Level With Equipotential Bonding Ground Terminal Block

技术参数Technical Parameter		
厚度Thickness	宽度Width	高度Height
5.2	100.7	56.4
IEC	UL	
*	*	
*	*	
接线容量Wire Range		
	刚性Solid	柔性Fine Stranded
	0.2-4	0.2-2.5
	26-12	26-12
		带冷压头Furrule
		0.2-2.5
		26-12
其余参数Other Parameters		
绝缘材料/阻燃等级, 符合UL94 Insulating Material / Flame Retardant Grade, Conforming To UL94		
	V0	
剥线长度Strip length	8-10	

订货信息Order Information

产品Product	颜色Colour	订货号Order NO.
适配NS 35/7.5导轨 Can Be Used For DIN Rail NS 35/7.5	黄绿Yellow green	TPT2.5-2-PE
		*
		*

配套附件Accessory

端板Cover Plate	订货号Order NO.
厚度2.2mm Thickness2.2mm	TPT2.5-2-GY-EA
	TPT2.5-2-OG-EA
	TPT2.5-2-BU-EA
补偿端板Compensatory Plate	订货号Order NO.
厚度1.00mm Thickness1.00mm	*
跨接件Jumper	订货号Order NO.
位数Poles No.	颜色Colour
2	黄Yellow
3	黄Yellow
4	黄Yellow
...
9	黄Yellow
10	黄Yellow
正面标记Front Marker	订货号Order NO.
10位PCS	*
正面标记和侧面标记Front And Side Marker	订货号Order NO.
可提供印字服务Printing Service	TMB5.2-120

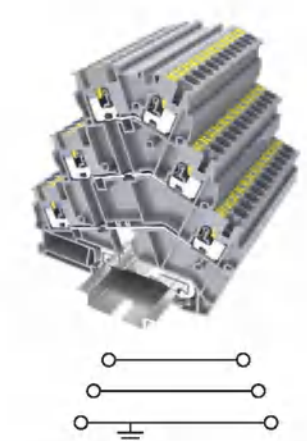

2.5mm² 三层斜面接地端子
Tripe level angled type ground terminal block

技术参数Technical Parameter		
厚度Thickness	宽度Width	高度Height
5.2	89.4	91
IEC	UL	
*	*	
*	*	
接线容量Wire Range		
	刚性Solid	柔性Fine Stranded
	0.14-2.5	0.14-2.5
	26-12	26-12
		带冷压头Furrule
		0.14-2.5
		26-12
其余参数Other Parameters		
绝缘材料/阻燃等级, 符合UL94 Insulating Material / Flame Retardant Grade, Conforming To UL94		
	V0	
剥线长度Strip length	8-10	

订货信息Order Information

产品Product	颜色Colour	订货号Order NO.
适配NS 35/7.5导轨 Can Be Used For DIN Rail NS 35/7.5	黄绿Yellow green	TPTS2.5-2-PET
		*
		*

配套附件Accessory

端板Cover Plate	订货号Order NO.
厚度2.2mm Thickness2.2mm	TPTS2.5-2-GY-EC
	TPTS2.5-2-OG-EC
补偿端板Compensatory Plate	订货号Order NO.
厚度1.00mm Thickness1.00mm	*
跨接件Jumper	订货号Order NO.
位数Poles No.	颜色Colour
2	黄Yellow
3	黄Yellow
4	黄Yellow
...
9	黄Yellow
10	黄Yellow
正面标记Front Marker	订货号Order NO.
10位PCS	*
正面标记和侧面标记Front And Side Marker	订货号Order NO.
可提供印字服务Printing Service	TMB5.2-120

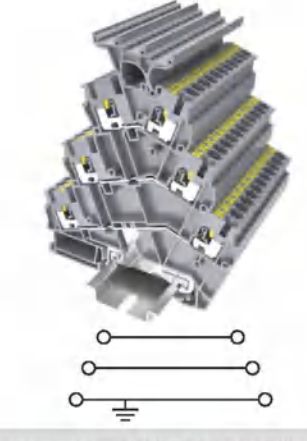

2.5mm² 三层斜面接地端子带支架
Tripe level angled type ground terminal block with marker carrier

技术参数Technical Parameter		
厚度Thickness	宽度Width	高度Height
5.2	89.4	91
IEC	UL	
*	*	
*	*	
接线容量Wire Range		
	刚性Solid	柔性Fine Stranded
	0.14-2.5	0.14-2.5
	26-12	26-12
		带冷压头Furrule
		0.14-2.5
		26-12
其余参数Other Parameters		
绝缘材料/阻燃等级, 符合UL94 Insulating Material / Flame Retardant Grade, Conforming To UL94		
	V0	
剥线长度Strip length	8-10	

订货信息Order Information

产品Product	颜色Colour	订货号Order NO.
适配NS 35/7.5导轨 Can Be Used For DIN Rail NS 35/7.5	黄绿Yellow green	TPTS2.5-2T-PET
		*
		*

配套附件Accessory

端板Cover Plate	订货号Order NO.
厚度2.2mm Thickness2.2mm	TPTS2.5-2-GY-EC
	TPTS2.5-2-OG-EC
补偿端板Compensatory Plate	订货号Order NO.
厚度1.00mm Thickness1.00mm	*
跨接件Jumper	订货号Order NO.
位数Poles No.	颜色Colour
2	黄Yellow
3	黄Yellow
4	黄Yellow
...
9	黄Yellow
10	黄Yellow
正面标记Front Marker	订货号Order NO.
10位PCS	*
正面标记和侧面标记Front And Side Marker	订货号Order NO.
可提供印字服务Printing Service	TMB5.2-120

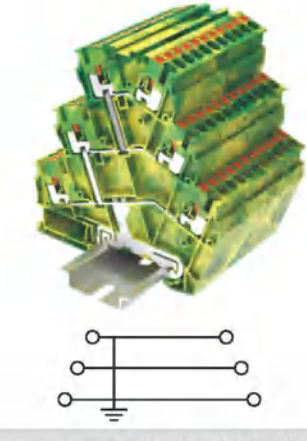

2.5mm² 三层斜面等电位接地端子
Tripe level angled type ground terminal block with equipotential bonding

技术参数Technical Parameter		
厚度Thickness	宽度Width	高度Height
5.2	89.1	91
IEC	UL	
*	*	
*	*	
接线容量Wire Range		
	刚性Solid	柔性Fine Stranded
	0.14-2.5	0.14-2.5
	26-12	26-12
		带冷压头Furrule
		0.14-2.5
		26-12
其余参数Other Parameters		
绝缘材料/阻燃等级, 符合UL94 Insulating Material / Flame Retardant Grade, Conforming To UL94		
	V0	
剥线长度Strip length	8-10	

订货信息Order Information

产品Product	颜色Colour	订货号Order NO.
适配NS 35/7.5导轨 Can Be Used For DIN Rail NS 35/7.5	黄绿Yellow green	TPTS2.5-2-PE
		*
		*

配套附件Accessory

端板Cover Plate	订货号Order NO.
厚度2.2mm Thickness2.2mm	TPTS2.5-2-GY-EC
	TPTS2.5-2-OG-EC
补偿端板Compensatory Plate	订货号Order NO.
厚度1.00mm Thickness1.00mm	*
跨接件Jumper	订货号Order NO.
位数Poles No.	颜色Colour
2	黄Yellow
3	黄Yellow
4	黄Yellow
...
9	黄Yellow
10	黄Yellow
正面标记Front Marker	订货号Order NO.
10位PCS	*
正面标记和侧面标记Front And Side Marker	订货号Order NO.
可提供印字服务Printing Service	TMB5.2-120

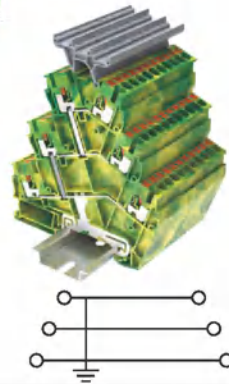

2.5mm² 三层斜面等电位接地端子带支架
Tripe level angled type ground terminal block with equipotential bond and marker carrier

技术参数Technical Parameter

厚度Thickness	宽度Width	高度Height
5.2	89.4	91
IEC	UL	
*	*	
*	*	
刚性Solid	柔性Fine Stranded	带冷压头Furrule
0.14-2.5	0.14-2.5	0.14-2.5
26-12	26-12	26-12

尺寸Size	
注: 安装NS35/7.5导轨后的高度 Note: Height With DIN Rail NS 35/7.5	[mm]
额定参数Rated Parameters	
额定电压Rated Voltage	[V]
额定电流Rated Current	[A]
接线容量Wire Range	
	[mm²]
	[AWG]

其余参数Other Parameters	
绝缘材料/阻燃等级, 符合UL94 Insulating Material / Flame Retardant Grade, Conforming To UL94	V0
剥线长度Strip length	[mm] 8-10

订货信息Order Information

产品Product	颜色Colour	订货号Order NO.
适配NS 35/7.5导轨 Can Be Used For DIN Rail NS 35/7.5	黄Yellow green	TPTS2.5-2T-PE
		*
		*

配套附件Accessory

端板Cover Plate	厚度2.2mm Thickness2.2mm	订货号Order NO.
灰Gray	橙Orange	TPTS2.5-2-GY-EC
	蓝Blue	TPTS2.5-2-OG-EC

端板Cover Plate	厚度2.2mm Thickness2.2mm
灰Gray	橙Orange
	蓝Blue

补偿端板Compensatory Plate	厚度1.00mm Thickness1.00mm	订货号Order NO.
灰Gray		*

补偿端板Compensatory Plate	厚度1.00mm Thickness1.00mm
灰Gray	

跨接件Jumper	位数Poles No.	颜色Colour	订货号Order NO.
	2	黄Yellow	TJA5.2-2
	3	黄Yellow	TJA5.2-3
	4	黄Yellow	TJA5.2-4

	9	黄Yellow	TJA5.2-9
	10	黄Yellow	TJA5.2-10

跨接件Jumper	位数Poles No.	颜色Colour
	2	黄Yellow
	3	黄Yellow
	4	黄Yellow

	9	黄Yellow
	10	黄Yellow

正面标记Front Marker	10位PCS	正面标记和侧面标记Front And Side Marker	可提供印字服务Printing Service
	*	订货号Order NO.	TMB5.2-120

正面标记Front Marker	10位PCS	正面标记和侧面标记Front And Side Marker	可提供印字服务Printing Service
	*	订货号Order NO.	TMB5.2-120

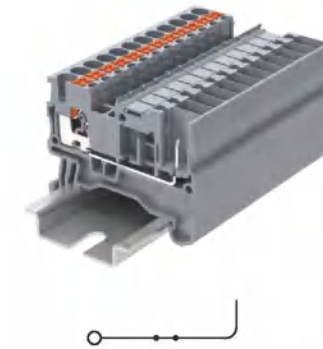

2.5mm² 一针一线接线端子
Carrier terminal block

技术参数Technical Parameter

厚度Thickness	宽度Width	高度Height
5.2	48.5	36.5
IEC	UL	
500	600	
24	20	
刚性Solid	柔性Fine Stranded	带冷压头Furrule
0.2-4	0.2-2.5	0.2-2.5
26-12	26-12	26-12

尺寸Size	
注: 安装NS35/7.5导轨后的高度 Note: Height With DIN Rail NS 35/7.5	[mm]
额定参数Rated Parameters	
额定电压Rated Voltage	[V]
额定电流Rated Current	[A]
接线容量Wire Range	
	[mm²]
	[AWG]

其余参数Other Parameters	
绝缘材料/阻燃等级, 符合UL94 Insulating Material / Flame Retardant Grade, Conforming To UL94	V0
剥线长度Strip length	[mm] 8-10

订货信息Order Information

产品Product	颜色Colour	订货号Order NO.
适配NS 35/7.5导轨 Can Be Used For DIN Rail NS 35/7.5	灰Gray	TP2.5-2-1-GY
	橙Orange	TP2.5-2-1-OG
	蓝Blue	TP2.5-2-1-BU

产品Product	颜色Colour
适配NS 35/7.5导轨 Can Be Used For DIN Rail NS 35/7.5	灰Gray
	橙Orange
	蓝Blue

配套附件Accessory

端板Cover Plate	厚度2.2mm Thickness2.2mm	订货号Order NO.
灰Gray	橙Orange	TP2.5-2-1-GY-EA
	蓝Blue	TP2.5-2-1-OG-EA
		TP2.5-2-1-BU-EA

端板Cover Plate	厚度2.2mm Thickness2.2mm
灰Gray	橙Orange
	蓝Blue

补偿端板Compensatory Plate	厚度1.00mm Thickness1.00mm	订货号Order NO.
灰Gray		*

补偿端板Compensatory Plate	厚度1.00mm Thickness1.00mm
灰Gray	

跨接件Jumper	位数Poles No.	颜色Colour	订货号Order NO.
	2	黄Yellow	TJA5.2-2
	3	黄Yellow	TJA5.2-3
	4	黄Yellow	TJA5.2-4

	9	黄Yellow	TJA5.2-9
	10	黄Yellow	TJA5.2-10

跨接件Jumper	位数Poles No.	颜色Colour
	2	黄Yellow
	3	黄Yellow
	4	黄Yellow

	9	黄Yellow
	10	黄Yellow

正面标记Front Marker	10位PCS	正面标记和侧面标记Front And Side Marker	可提供印字服务Printing Service
	*	订货号Order NO.	TMB5.2-120

正面标记Front Marker	10位PCS	正面标记和侧面标记Front And Side Marker	可提供印字服务Printing Service
	*	订货号Order NO.	TMB5.2-120



2.5mm² 插头 Plug

技术参数Technical Parameter

尺寸Size	
注: 安装NS35/7.5导轨后的高度 Note: Height With DIN Rail NS 35/7.5	[mm]
额定参数Rated Parameters	
额定电压Rated Voltage	[V]
额定电流Rated Current	[A]
接线容量Wire Range	
	[mm²]
	[AWG]
其余参数Other Parameters	
绝缘材料/阻燃等级, 符合UL94 Insulating Material / Flame Retardant Grade, Conforming To UL94	V0
剥线长度Strip length	[mm]

厚度Thickness	宽度Width	高度Height
IEC	UL	
500	300	
24	20	
接线容量Wire Range		
刚性Solid	柔性Fine Stranded	带冷压头Furrule
0.2-4	0.2-2.5	0.2-2.5
26-12	26-12	26-12
其余参数Other Parameters		
绝缘材料/阻燃等级, 符合UL94 Insulating Material / Flame Retardant Grade, Conforming To UL94	V0	
剥线长度Strip length	[mm]	8-10

位数Poles No.	颜色Colour
1	灰
2	灰
...	...
14	灰
15	灰
1	橙Orange
1	蓝Blue
1	黄绿Yellow green

跨接件Jumper	
位数Poles No.	颜色Colour
2	黄Yellow
3	黄Yellow
4	黄Yellow
...
9	黄Yellow
10	黄Yellow
闪电标记Lightning Marker	
5位PCS	*
正面标记Front Marker	
10位PCS	*
正面标记和侧面标记Front And Side Marker	
可提供印字服务Printing Service	TMB5.2-120

订货信息Order Information	
订货号Order NO.	TPP2.5-1-GY
	TPP2.5-2-GY
	...
	TPP2.5-14-GY
	TPP2.5-15-GY
	TPP2.5-1-OG
	TPP2.5-1-BU
	TPP2.5-1-PE
跨接件Jumper	
位数Poles No.	颜色Colour
2	黄Yellow
3	黄Yellow
4	黄Yellow
...
9	黄Yellow
10	黄Yellow
闪电标记Lightning Marker	
5位PCS	*
正面标记Front Marker	
10位PCS	*
正面标记和侧面标记Front And Side Marker	
可提供印字服务Printing Service	TMB5.2-120



1.5mm² 一进一出直插式微型接线端子
1.5mm² Conductor push-in mini terminal block

技术参数Technical Parameter

厚度Thickness	宽度Width	高度Height
3.5	31	26.4
IEC	UL	
500	600	
17.5	15	
接线容量Wire Range		
刚性Solid	柔性Fine Stranded	带冷压头Furrule
0.2-1.5	0.2-1.5	0.2-1.5
16-14	16-14	16-14
其余参数Other Parameters		
绝缘材料/阻燃等级, 符合UL94 Insulating Material / Flame Retardant Grade, Conforming To UL94	V0	
剥线长度Strip length	[mm]	8-9

订货信息Order Information	
订货号Order NO.	TPM1.5-2-GY
	TPM1.5-2-OG
	TPM1.5-2-BU

配套附件Accessory	
订货号Order NO.	TPM1.5-2-GY-EA
	TPM1.5-2-OG-EA
	TPM1.5-2-BU-EA

跨接件Jumper	
位数Poles No.	颜色Colour
2	黄Yellow
3	黄Yellow
4	黄Yellow
...
9	黄Yellow
10	黄Yellow
闪电标记Lightning Marker	
5位PCS	*
正面标记Front Marker	
10位PCS	*
正面标记和侧面标记Front And Side Marker	
可提供印字服务Printing Service	TMB3.5-100



1.5mm² 一进一出直插式微型接地端子
1.5mm² Conductor push-in mini grounding terminal block

技术参数Technical Parameter

厚度Thickness	宽度Width	高度Height
3.5	31	26.4
IEC	UL	
500	600	
17.5	15	
接线容量Wire Range		
刚性Solid	柔性Fine Stranded	带冷压头Furrule
0.2-1.5	0.2-1.5	0.2-1.5
16-14	16-14	16-14
其余参数Other Parameters		
绝缘材料/阻燃等级, 符合UL94 Insulating Material / Flame Retardant Grade, Conforming To UL94	V0	
剥线长度Strip length	[mm]	8-9

订货信息Order Information	
订货号Order NO.	TPM1.5-2-PE
	*
	*
	*

配套附件Accessory	
订货号Order NO.	TPM1.5-2-GY-EA
	TPM1.5-2-OG-EA
	TPM1.5-2-BU-EA

跨接件Jumper	
位数Poles No.	颜色Colour
2	黄Yellow
3	黄Yellow
4	黄Yellow
...
9	黄Yellow
10	黄Yellow
闪电标记Lightning Marker	
5位PCS	*
正面标记Front Marker	
10位PCS	*
正面标记和侧面标记Front And Side Marker	
可提供印字服务Printing Service	TMB3.5-100

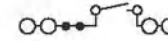
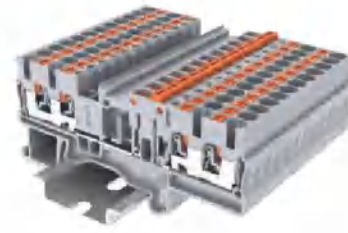
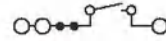
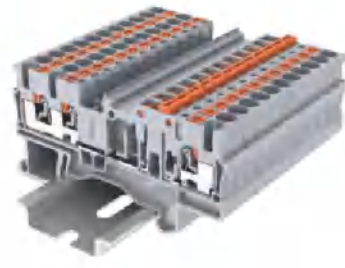
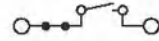

2.5mm²一进一出带刀闸正面接线
1-1 feed through knife disconnect terminal blocks

2.5mm²两进一出带刀闸正面接线
2-1 feed through knife disconnect terminal blocks

2.5mm²两进两出带刀闸正面接线
2-2 feed through knife disconnect terminal blocks

6mm²闸刀试验端子
Disconnect test terminal

6mm²闸刀试验端子带测试柱
Disconnect test terminal with test tube

尺寸Size	
注: 安装NS35/7.5导轨后的高度 Note: Height With DIN Rail NS 35/7.5	[mm]
额定电压Rated Voltage	[V]
额定电流Rated Current	[A]
接线容量Wire Range	[mm ²] [AWG]
其余参数Other Parameters	
绝缘材料/阻燃等级, 符合UL94 Insulating Material / Flame Retardant Grade, Conforming To UL94	
剥线长度Strip length	[mm]

技术参数Technical Parameter		
厚度Thickness	宽度Width	高度Height
5.2	61.7	33.5
IEC	UL	
400	300	
20	20	
刚性Solid	柔性Fine Stranded	带冷压头Furrule
0.2-4	0.2-2.5	0.2-2.5
26-12	26-12	26-12
V0		
8-10		

技术参数Technical Parameter		
厚度Thickness	宽度Width	高度Height
5.2	71.9	33.5
IEC	UL	
400	300	
20	20	
刚性Solid	柔性Fine Stranded	带冷压头Furrule
0.2-4	0.2-2.5	0.2-2.5
26-12	26-12	26-12
V0		
8-10		

技术参数Technical Parameter		
厚度Thickness	宽度Width	高度Height
5.2	82.2	33.5
IEC	UL	
400	300	
20	20	
刚性Solid	柔性Fine Stranded	带冷压头Furrule
0.2-4	0.2-2.5	0.2-2.5
26-12	26-12	26-12
V0		
8-10		

技术参数Technical Parameter		
厚度Thickness	宽度Width	高度Height
8.2	103.2	48.5
IEC	UL	
1000	600	
30	30	
刚性Solid	柔性Fine Stranded	带冷压头Furrule
0.5-10	0.5-6	0.5-6
20-8	20-8	20-8
V0		
12		

技术参数Technical Parameter		
厚度Thickness	宽度Width	高度Height
82	103.2	48.5
IEC	UL	
1000	600	
30	30	
刚性Solid	柔性Fine Stranded	带冷压头Furrule
0.5-10	0.5-6	0.5-6
20-8	20-8	20-8
V0		
12		

产品Product	
颜色Colour	灰Gray
	橙Orange
	蓝Blue

订货信息Order Information	
订货号Order NO.	TPK2.5-2-GY
	TPK2.5-2-OG
	TPK2.5-2-BU

订货信息Order Information	
订货号Order NO.	TPK2.5-3-GY
	TPK2.5-3-OG
	TPK2.5-3-BU

订货信息Order Information	
订货号Order NO.	TPK2.5-4-GY
	TPK2.5-4-OG
	TPK2.5-4-BU

订货信息Order Information	
订货号Order NO.	TPME6-2-GY

订货信息Order Information	
订货号Order NO.	TPME6-2-JP-GY

配件附件Accessory	
盖板Cover Plate	灰Gray
厚度2.2mm Thickness2.2mm	橙Orange
	蓝Blue
补偿端板Compensatory Plate	灰Gray
厚度1.00mm Thickness1.00mm	
跨接件Jumper	
位数Poles No.	颜色Colour
2	黄Yellow
3	黄Yellow
4	黄Yellow
...	...
9	黄Yellow
10	黄Yellow
闪电标记Lightning Marker	
5位PCS	
正面标记Front Marker	
10位PCS	
正面标记和侧面标记Front And Side Marker	
可提供印字服务Printing Service	

配件附件Accessory	
订货号Order NO.	TPK2.5-2-GY-EA
	TPK2.5-2-OG-EA
	TPK2.5-2-BU-EA
订货号Order NO.	*
订货号Order NO.	
订货号Order NO.	TJA5.2-2
	TJA5.2-3
	TJA5.2-4

	TJA5.2-9
	TJA5.2-10
订货号Order NO.	*
订货号Order NO.	*
订货号Order NO.	305801
订货号Order NO.	*
订货号Order NO.	TMB5.2-120

配件附件Accessory	
订货号Order NO.	TPK2.5-3-GY-EA
	TPK2.5-3-OG-EA
	TPK2.5-3-BU-EA
订货号Order NO.	*
订货号Order NO.	
订货号Order NO.	TJA5.2-2
	TJA5.2-3
	TJA5.2-4

	TJA5.2-9
	TJA5.2-10
订货号Order NO.	*
订货号Order NO.	*
订货号Order NO.	305801
订货号Order NO.	*
订货号Order NO.	TMB5.2-120

配件附件Accessory	
订货号Order NO.	TPME6-2-JP-GY-EA
	*
	*
订货号Order NO.	*
订货号Order NO.	
订货号Order NO.	TJA8.2-2
	TJA8.2-3
	TJA8.2-4

	TJA8.2-9
	TJA8.2-10
订货号Order NO.	*
订货号Order NO.	*
订货号Order NO.	308801
订货号Order NO.	*
订货号Order NO.	TMB8.2-50

配件附件Accessory	
订货号Order NO.	TPME6-2-JP-GY-EA
	*
	*
订货号Order NO.	*
订货号Order NO.	
订货号Order NO.	TJA8.2-2
	TJA8.2-3
	TJA8.2-4

	TJA8.2-9
	TJA8.2-10
订货号Order NO.	*
订货号Order NO.	*
订货号Order NO.	308801
订货号Order NO.	*
订货号Order NO.	TMB8.2-50

配件附件Accessory	
订货号Order NO.	TPME6-2-JP-GY-EA
	*
	*
订货号Order NO.	*
订货号Order NO.	
订货号Order NO.	TJA8.2-2
	TJA8.2-3
	TJA8.2-4

	TJA8.2-9
	TJA8.2-10
订货号Order NO.	*
订货号Order NO.	*
订货号Order NO.	308801
订货号Order NO.	*
订货号Order NO.	TMB8.2-50

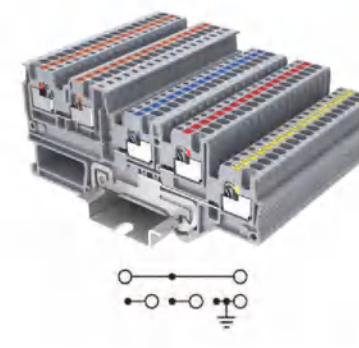
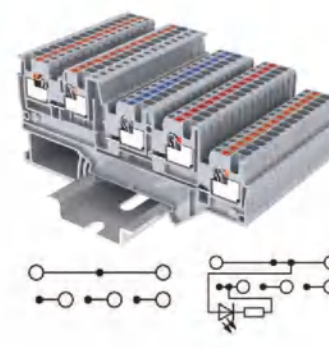
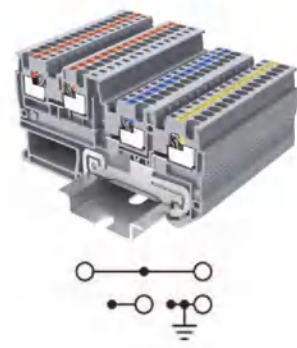
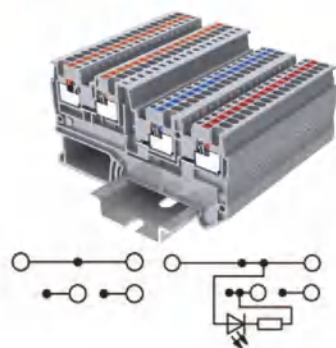

尺寸Size	
注: 安装NS35/7.5导轨后的高度 Note: Height With DIN Rail NS 35/7.5	[mm]
额定参数Rated Parameters	
额定电压Rated Voltage	[V]
额定电流Rated Current	[A]
接线容量Wire Range	
	[mm²]
	[AWG]
其余参数Other Parameters	
绝缘材料/阻燃等级, 符合UL94 Insulating Material / Flame Retardant Grade, Conforming To UL94	
剥线长度Strip length	[mm]
产品Product	颜色Colour
适配NS 35/7.5导轨 Can Be Used For DIN Rail NS 35/7.5	灰Gray
	灰, 带红灯With red light
	灰, 带绿灯With green light
	橙Orange
端板Cover Plate	
厚度2.2mm Thickness2.2mm	灰Gray
	橙Orange
	蓝Blue
补偿端板Compensatory Plate	
厚度1.00mm Thickness1.00mm	灰Gray
跨接件Jumper	
位数Poles No.	颜色Colour
2	黄Yellow
3	黄Yellow
4	黄Yellow
...
9	黄Yellow
10	黄Yellow
正面标记Front Marker	
10位PCS	*
正面标记和侧面标记Front And Side Marker	
可提供印字服务Printing Service	

1.5mm² 三线启动器端子 Initiator terminal block 3-wire			
技术参数Technical Parameter			
厚度Thickness	宽度Width	高度Height	
3.5	74.5	41.5	
IEC	UL		
250	*		
13.5	*		
刚性Solid	柔性Fine Stranded	带冷压头Furrule	
0.14-1.5	0.14-1.5	0.14-1.5	
26-14	26-14	26-14	
其余参数Other Parameters			
绝缘材料/阻燃等级, 符合UL94 Insulating Material / Flame Retardant Grade, Conforming To UL94			
剥线长度Strip length [mm]			
V0			
8-9			
订货信息Order Information			
订货号Order NO.			
TPIO1.5-S-3			
TPIO1.5-S-3-LR24			
TPIO1.5-S-3-LG24			
*			
配套附件Accessory			
订货号Order NO.			
TPIO1.5-S-3-GY-EA			
TPIO1.5-S-3-OG-EA			
TPIO1.5-S-3-BU-EA			
订货号Order NO.			
*			
位数Poles No.	颜色Colour	订货号Order NO.	
2	黄Yellow	TJA3.5-2	
3	黄Yellow	TJA3.5-3	
4	黄Yellow	TJA3.5-4	
...	
9	黄Yellow	TJA3.5-9	
10	黄Yellow	TJA3.5-10	
正面标记Front Marker		订货号Order NO.	
10位PCS		*	
正面标记和侧面标记Front And Side Marker		订货号Order NO.	
可提供印字服务Printing Service		TMB3.5-100	

1.5mm² 三线执行器端子 Actuator terminal block 3-wire			
技术参数Technical Parameter			
厚度Thickness	宽度Width	高度Height	
3.5	74.5	41.5	
IEC	UL		
250	*		
13.5	*		
刚性Solid	柔性Fine Stranded	带冷压头Furrule	
0.14-1.5	0.14-1.5	0.14-1.5	
26-14	26-14	26-14	
其余参数Other Parameters			
绝缘材料/阻燃等级, 符合UL94 Insulating Material / Flame Retardant Grade, Conforming To UL94			
剥线长度Strip length [mm]			
V0			
8-9			
订货信息Order Information			
订货号Order NO.			
TPIO1.5-S-3-PE			
*			
*			
配套附件Accessory			
订货号Order NO.			
TPIO1.5-S-3-GY-EA			
TPIO1.5-S-3-OG-EA			
TPIO1.5-S-3-BU-EA			
订货号Order NO.			
*			
位数Poles No.	颜色Colour	订货号Order NO.	
2	黄Yellow	TJA3.5-2	
3	黄Yellow	TJA3.5-3	
4	黄Yellow	TJA3.5-4	
...	
9	黄Yellow	TJA3.5-9	
10	黄Yellow	TJA3.5-10	
正面标记Front Marker		订货号Order NO.	
10位PCS		*	
正面标记和侧面标记Front And Side Marker		订货号Order NO.	
可提供印字服务Printing Service		TMB3.5-100	

1.5mm² 四线启动器端子 Initiator terminal block 4-wire			
技术参数Technical Parameter			
厚度Thickness	宽度Width	高度Height	
3.5	90.8	41.5	
IEC	UL		
250	*		
13.5	*		
刚性Solid	柔性Fine Stranded	带冷压头Furrule	
0.14-1.5	0.14-1.5	0.14-1.5	
26-14	26-14	26-14	
其余参数Other Parameters			
绝缘材料/阻燃等级, 符合UL94 Insulating Material / Flame Retardant Grade, Conforming To UL94			
剥线长度Strip length [mm]			
V0			
8-9			
订货信息Order Information			
订货号Order NO.			
TPIO1.5-S-4			
TPIO1.5-S-4-LR24			
TPIO1.5-S-4-LG24			
*			
*			
配套附件Accessory			
订货号Order NO.			
TPIO1.5-S-4-GY-EA			
TPIO1.5-S-4-OG-EA			
TPIO1.5-S-4-BU-EA			
订货号Order NO.			
*			
位数Poles No.	颜色Colour	订货号Order NO.	
2	黄Yellow	TJA3.5-2	
3	黄Yellow	TJA3.5-3	
4	黄Yellow	TJA3.5-4	
...	
9	黄Yellow	TJA3.5-9	
10	黄Yellow	TJA3.5-10	
正面标记Front Marker		订货号Order NO.	
10位PCS		*	
正面标记和侧面标记Front And Side Marker		订货号Order NO.	
可提供印字服务Printing Service		TMB3.5-100	

1.5mm² 四线执行器端子 Actuator terminal block 4-wire			
技术参数Technical Parameter			
厚度Thickness	宽度Width	高度Height	
3.5	90.8	41.5	
IEC	UL		
250	*		
13.5	*		
刚性Solid	柔性Fine Stranded	带冷压头Furrule	
0.14-1.5	0.14-1.5	0.14-1.5	
26-14	26-14	26-14	
其余参数Other Parameters			
绝缘材料/阻燃等级, 符合UL94 Insulating Material / Flame Retardant Grade, Conforming To UL94			
剥线长度Strip length [mm]			
V0			
8-9			
订货信息Order Information			
订货号Order NO.			
TPIO1.5-S-4-PE			
*			
*			
配套附件Accessory			
订货号Order NO.			
TPIO1.5-S-4-GY-EA			
TPIO1.5-S-4-OG-EA			
TPIO1.5-S-4-BU-EA			
订货号Order NO.			
*			
位数Poles No.	颜色Colour	订货号Order NO.	
2	黄Yellow	TJA3.5-2	
3	黄Yellow	TJA3.5-3	
4	黄Yellow	TJA3.5-4	
...	
9	黄Yellow	TJA3.5-9	
10	黄Yellow	TJA3.5-10	
正面标记Front Marker		订货号Order NO.	
10位PCS		*	
正面标记和侧面标记Front And Side Marker		订货号Order NO.	
可提供印字服务Printing Service		TMB3.5-100	

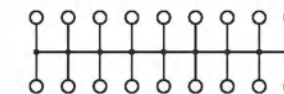
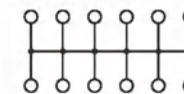

2.5mm² 直插式2位配电块
Push-in Type Power Distribution Block
2.5mm² 2 Terminal Points

2.5mm² 直插式6位配电块
Push-in Type Power Distribution Block
2.5mm² 6 Terminal Points

2.5mm² 直插式12位配电块
Push-in Type Power Distribution Block
2.5mm² 12 Terminal Points

2.5mm² 直插式18位配电块
Push-in Type Power Distribution Block
2.5mm² 18 Terminal Points

尺寸Size	
[mm]	
厚度Thickness	5.2
长度Length	28.6
高度Height	21.7
额定参数Rated Parameters	
额定电压Rated Voltage [V]	500
额定电流Rated Current [A]	24
接线容量Wire Range	
[mm ²]	0.2-4
[AWG]	24-14
其余参数Other Parameters	
绝缘材料/阻燃等级, 符合UL94 Insulating Material / Flame Retardant Grade, Conforming To UL94	V0
剥线长度Strip Length [mm]	8-10

技术参数Technical Parameter		
厚度Thickness	长度Length	高度Height
5.2	28.6	21.7
IEC		
500		
24		
刚性Solid	柔性Fine Stranded	带冷压头Furrule
0.2-4	0.2-2.5	0.2-2.5
24-14	24-14	24-14
V0		
8-10		

技术参数Technical Parameter		
厚度Thickness	长度Length	高度Height
16.1	28.6	21.7
IEC		
500		
24		
刚性Solid	柔性Fine Stranded	带冷压头Furrule
0.2-4	0.2-2.5	0.2-2.5
24-14	24-14	24-14
V0		
8-10		

尺寸Size	
[mm]	
厚度Thickness	31.6
长度Length	28.6
高度Height	21.7
额定参数Rated Parameters	
额定电压Rated Voltage [V]	500
额定电流Rated Current [A]	24
接线容量Wire Range	
[mm ²]	0.2-4
[AWG]	24-14
其余参数Other Parameters	
绝缘材料/阻燃等级, 符合UL94 Insulating Material / Flame Retardant Grade, Conforming To UL94	V0
剥线长度Strip Length [mm]	8-10

技术参数Technical Parameter		
厚度Thickness	长度Length	高度Height
31.6	28.6	21.7
IEC		
500		
24		
刚性Solid	柔性Fine Stranded	带冷压头Furrule
0.2-4	0.2-2.5	0.2-2.5
24-14	24-14	24-14
V0		
8-10		

技术参数Technical Parameter		
厚度Thickness	长度Length	高度Height
47	28.6	21.7
IEC		
500		
24		
刚性Solid	柔性Fine Stranded	带冷压头Furrule
0.2-4	0.2-2.5	0.2-2.5
24-14	24-14	24-14
V0		
8-10		

产品Product		颜色Colour
		灰Gray
		橙Orange
		蓝Blue
配套附件Accessory		
		订货号Order NO.
大导轨转换器 Din rail adapter for NS35	灰Gray	TPA NS 35
小导轨转换器 Din rail adapter for NS15	灰Gray	TPA NS 15
导轨卡板 Din rail bracket	灰Gray	TPA NS 35T
螺钉法兰 Flange for screw mounting	灰Gray	TPA2.5 NF
法兰标记支架 Marking carrier	灰Gray	TPA-KLM3

订货信息Order Information	
	订货号Order NO.
	TPA 2.5-2-GY
	TPA 2.5-2-OG
	TPA 2.5-2-BU
配套附件Accessory	
	订货号Order NO.
	TPA NS 35
	TPA NS 15
	TPA NS 35T
	TPA2.5 NF
	TPA-KLM3

订货信息Order Information	
	订货号Order NO.
	TPA 2.5-6-GY
	TPA 2.5-6-OG
	TPA 2.5-6-BU
配套附件Accessory	
	订货号Order NO.
	TPA NS 35
	TPA NS 15
	TPA NS 35T
	TPA2.5 NF
	TPA-KLM3

产品Product		颜色Colour
		灰Gray
		橙Orange
		蓝Blue
配套附件Accessory		
		订货号Order NO.
大导轨转换器 Din rail adapter for NS35	灰Gray	TPA NS 35
小导轨转换器 Din rail adapter for NS15	灰Gray	TPA NS 15
导轨卡板 Din rail bracket	灰Gray	TPA NS 35T
螺钉法兰 Flange for screw mounting	灰Gray	TPA2.5 NF
法兰标记支架 Marking carrier	灰Gray	TPA-KLM3

订货信息Order Information	
	订货号Order NO.
	TPA 2.5-12-GY
	TPA 2.5-12-OG
	TPA 2.5-12-BU
配套附件Accessory	
	订货号Order NO.
	TPA NS 35
	TPA NS 15
	TPA NS 35T
	TPA2.5 NF
	TPA-KLM3

订货信息Order Information	
	订货号Order NO.
	TPA 2.5-18-GY
	TPA 2.5-18-OG
	TPA 2.5-18-BU
配套附件Accessory	
	订货号Order NO.
	TPA NS 35
	TPA NS 15
	TPA NS 35T
	TPA2.5 NF
	TPA-KLM3

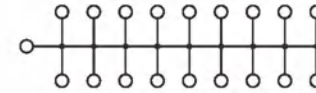
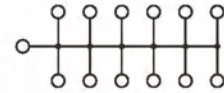
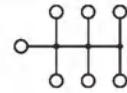

2.5mm² 直插式带输入7位配电块
Push-in Type Power Distribution Block
2.5mm² 7 Terminal Points

2.5mm² 直插式带输入13位配电块
Push-in Type Power Distribution Block
2.5mm² 13 Terminal Points

2.5mm² 直插式带输入19位配电块
Push-in Type Power Distribution Block
2.5mm² 19 Terminal Points

尺寸Size	
	[mm]
额定参数Rated Parameters	IEC
输入端Input	
额定电压Rated Voltage	[V] 500
额定电流Rated Current	[A] 41
输出端Output	
额定电压Rated Voltage	[V] 500
额定电流Rated Current	[A] 24
接线容量Wire Range	
输入端Input	
	[mm ²] 0.5-10
	[AWG] 20-10
输出端Output	
	[mm ²] 0.2-4
	[AWG] 24-14
其余参数Other Parameters	
绝缘材料/阻燃等级, 符合UL94 Insulating Material / Flame Retardant Grade, Conforming To UL94	V0
输入端Input	
剥线长度Strip Length	[mm] 10-12
输出端Output	
剥线长度Strip Length	[mm] 8-10
产品Product	颜色Colour
	灰Gray
	橙Orange
	蓝Blue
大导轨转换器 Din rail adapter for NS35	灰Gray
小导轨转换器 Din rail adapter for NS15	灰Gray
导轨卡板 Din rail bracket	灰Gray
螺钉法兰 Flange for screw mounting	灰Gray
法兰标记支架 Marking carrier	灰Gray

技术参数Technical Parameter		
厚度Thickness	长度Length	高度Height
25.6	28.6	21.7
IEC		
500		
41		
500		
24		
刚性Solid	柔性Fine Stranded	带冷压头Furrule
0.5-10	0.5-6	0.5-6
20-10	20-10	20-10
0.2-4	0.2-2.5	0.2-2.5
24-14	24-14	24-14
订货信息Order Information		
订货号Order NO.		
TPA 6/2.5-7-GY		
TPA 6/2.5-7-OG		
TPA 6/2.5-7-BU		
配套附件Accessory		
订货号Order NO.		
TPA NS 35		
TPA NS 15		
TPA NS 35T		
TPA2.5 NF		
TPA-KLM3		

技术参数Technical Parameter		
厚度Thickness	长度Length	高度Height
41.1	28.6	21.7
IEC		
500		
41		
500		
24		
刚性Solid	柔性Fine Stranded	带冷压头Furrule
0.5-10	0.5-6	0.5-6
20-10	20-10	20-10
0.2-4	0.2-2.5	0.2-2.5
24-14	24-14	24-14
订货信息Order Information		
订货号Order NO.		
TPA 6/2.5-13-GY		
TPA 6/2.5-13-OG		
TPA 6/2.5-13-BU		
配套附件Accessory		
订货号Order NO.		
TPA NS 35		
TPA NS 15		
TPA NS 35T		
TPA2.5 NF		
TPA-KLM3		

技术参数Technical Parameter		
厚度Thickness	长度Length	高度Height
56.5	28.6	21.7
IEC		
500		
41		
500		
24		
刚性Solid	柔性Fine Stranded	带冷压头Furrule
0.5-10	0.5-6	0.5-6
20-10	20-10	20-10
0.2-4	0.2-2.5	0.2-2.5
24-14	24-14	24-14
订货信息Order Information		
订货号Order NO.		
TPA 6/2.5-19-GY		
TPA 6/2.5-19-OG		
TPA 6/2.5-19-BU		
配套附件Accessory		
订货号Order NO.		
TPA NS 35		
TPA NS 15		
TPA NS 35T		
TPA2.5 NF		
TPA-KLM3		

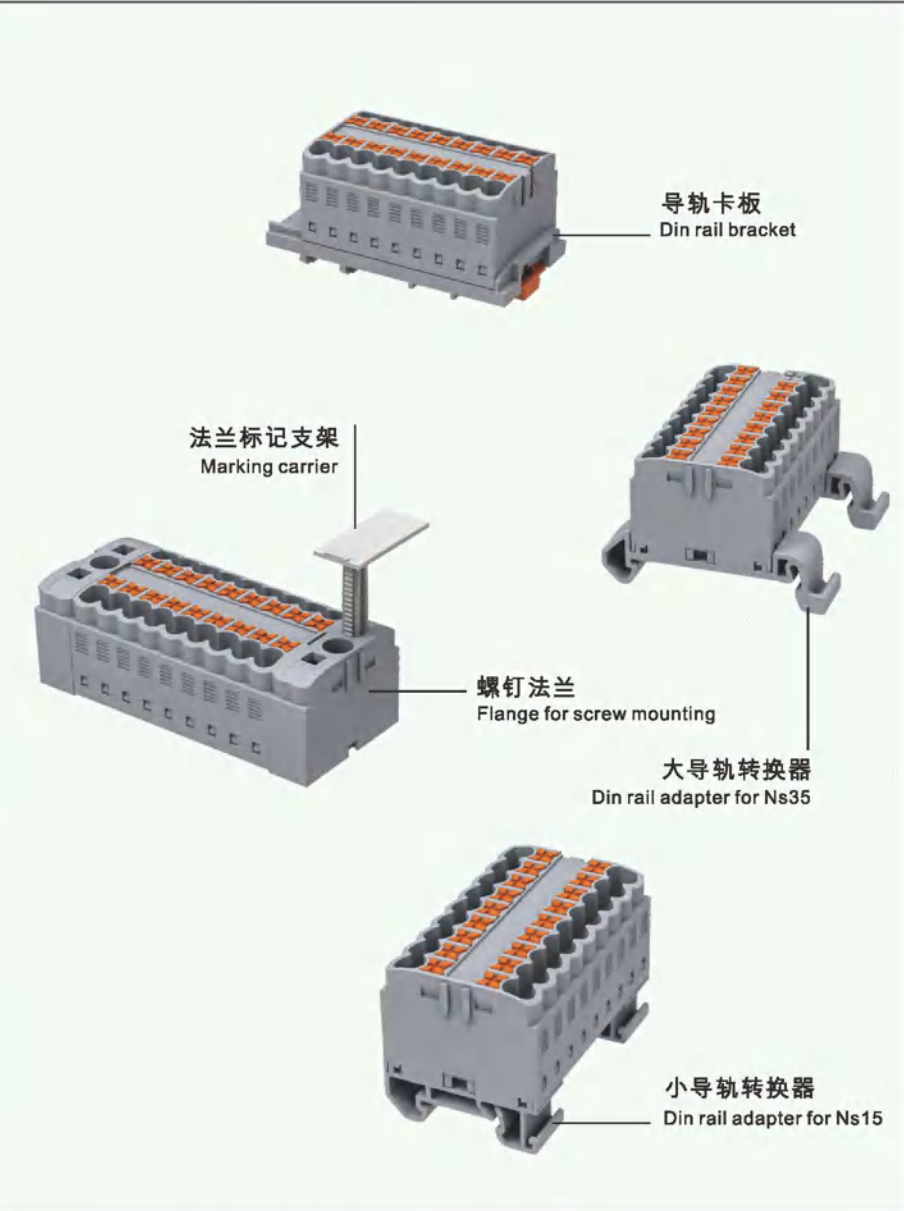

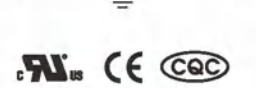
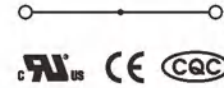
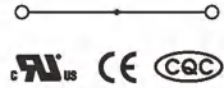
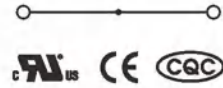
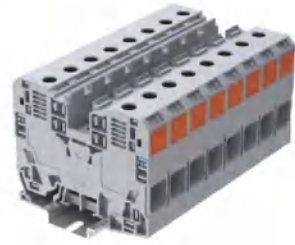

35mm²,大电流接线端子
High current terminal block

50mm²,大电流接线端子
High current terminal block

95mm²,大电流接线端子
High current terminal block

35mm²,大电流接地端子
High current ground terminal block

尺寸Size	
注: 安装NS35/7.5导轨后的高度 Note: Height With DIN Rail NS 35/7.5	[mm]
额定参数Rated Parameters	
额定电压Rated Voltage	[V]
额定电流Rated Current	[A]
接线容量Wire Range	
	[mm²]
	[AWG]
螺钉类型Screw Type	[*]
扭矩Torque	[N.m]
其余参数Other Parameters	
绝缘材料/阻燃等级, 符合UL94 Insulating Material / Flame Retardant Grade, Conforming To UL94	
剥线长度Strip length	[mm]

技术参数Technical Parameter		
厚度Thickness	宽度Width	高度Height
16	86	70.8
IEC		UL
1000	600	
125	115	
刚性Solid	柔性Fine Stranded	带冷压头Furrule
6-35	6-35	6-35
10-2	10-2	10-2
*		
V0		
25		

技术参数Technical Parameter		
厚度Thickness	宽度Width	高度Height
20	94	93
IEC		UL
1000	600	
150	150	
刚性Solid	柔性Fine Stranded	带冷压头Furrule
10-70	10-50	10-50
8-1/0	8-1/0	8-1/0
*		
V0		
30		

技术参数Technical Parameter		
厚度Thickness	宽度Width	高度Height
25	91	101.3
IEC		UL
1000	600	
232	200	
刚性Solid	柔性Fine Stranded	带冷压头Furrule
25-95	25-95	25-95
4-4/0	4-4/0	4-4/0
*		
V0		
35		

尺寸Size	
注: 安装NS35/7.5导轨后的高度 Note: Height With DIN Rail NS 35/7.5	[mm]
额定参数Rated Parameters	
额定电压Rated Voltage	[V]
额定电流Rated Current	[A]
接线容量Wire Range	
	[mm²]
	[AWG]
螺钉类型Screw Type	[*]
扭矩Torque	[N.m]
其余参数Other Parameters	
绝缘材料/阻燃等级, 符合UL94 Insulating Material / Flame Retardant Grade, Conforming To UL94	
剥线长度Strip length	[mm]

技术参数Technical Parameter		
厚度Thickness	宽度Width	高度Height
16	86	70.8
IEC		UL
1000	600	
125	115	
刚性Solid	柔性Fine Stranded	带冷压头Furrule
6-35	6-35	6-35
10-2	10-2	10-2
*		
V0		
25		

产品Product	
颜色Colour	灰Gray
	橙Orange
	蓝Blue

订货信息Order Information	
订货号Order NO.	TAPO35-2-GY
	TAPO35-2-OG
	TAPO35-2-BU

订货信息Order Information	
订货号Order NO.	TAPO50-2-GY
	TAPO50-2-OG
	TAPO50-2-BU

订货信息Order Information	
订货号Order NO.	TAPO95-2-GY
	TAPO95-2-OG
	TAPO95-2-BU

产品Product	
颜色Colour	黄绿Yellow green
	*
	*

订货信息Order Information	
订货号Order NO.	TAPO35-2-PE
	*
	*

端板Cover Plate	
颜色Colour	灰Gray
	橙Orange

配套附件Accessory	
订货号Order NO.	*
	*

配套附件Accessory	
订货号Order NO.	*
	*

配套附件Accessory	
订货号Order NO.	*
	*

端板Cover Plate	
颜色Colour	灰Gray
	橙Orange

配套附件Accessory	
订货号Order NO.	*
	*

跨接件Jumper	
位数Poles No.	
2	*
3	*
4	*
...
9	*
10	*

订货信息Order NO.	
	*
	*
	*

	*
	*

订货信息Order NO.	
	TJEB20-2
	*
	*
	*

	*
	*

订货信息Order NO.	
	*
	*
	*
	*

	*
	*

跨接件Jumper	
位数Poles No.	
2	*
3	*
4	*
...
9	*
10	*

订货信息Order NO.	
	*
	*
	*

	*
	*

正面标记(小)Front Marker(Small)	
订货号Order NO.	*
可提供印字服务Printing Service	

正面标记(大)Front Marker(Big)	
订货号Order NO.	225801
可提供印字服务Printing Service	

正面标记(小)Front Marker(Small)	
订货号Order NO.	*
可提供印字服务Printing Service	

正面标记(大)Front Marker(Big)	
订货号Order NO.	225801
可提供印字服务Printing Service	

正面标记(小)Front Marker(Small)	
订货号Order NO.	*
可提供印字服务Printing Service	

正面标记(大)Front Marker(Big)	
订货号Order NO.	225801
可提供印字服务Printing Service	

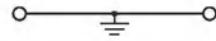

50mm²,大电流接地端子
High current ground terminal block

技术参数Technical Parameter

尺寸Size	厚度Thickness	宽度Width	高度Height
注: 安装NS35/7.5导轨后的高度 Note: Height With DIN Rail NS 35/7.5	20	94	93
额定参数Rated Parameters	IEC	UL	
额定电压Rated Voltage [V]	1000	600	
额定电流Rated Current [A]	150	150	
接线容量Wire Range	刚性Solid	柔性Fine Stranded	带冷压头Furrule
[mm²]	10-70	10-50	10-50
[AWG]	8-1/0	8-1/0	8-1/0
螺钉类型Screw Type [*]	*		
扭矩Torque [N.m]	*		
其余参数Other Parameters	绝缘材料/阻燃等级, 符合UL94 Insulating Material / Flame Retardant Grade, Conforming To UL94		
剥线长度Strip length [mm]	30		

订货信息Order Information

产品Product	颜色Colour	订货号Order NO.
适配NS 35/7.5导轨 Can Be Used For DIN Rail NS 35/7.5	黄绿Yellow green	TAPO50-2-PE
	*	*
	*	*

配套附件Accessory

端板Cover Plate	颜色Colour	订货号Order NO.
端板Cover Plate	灰Gray	*
	橙Orange	*

跨接件Jumper

位数Poles No.	订货号Order NO.
2	TJEB20-2
3	*
4	*
...
9	*
10	*

正面标记(小)Front Marker(Small)

可提供印字服务Printing Service *

正面标记(大)Front Marker(Big)

可提供印字服务Printing Service 225801

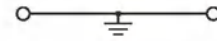

95mm²,大电流接地端子
High current ground terminal block

技术参数Technical Parameter

尺寸Size	厚度Thickness	宽度Width	高度Height
注: 安装NS35/7.5导轨后的高度 Note: Height With DIN Rail NS 35/7.5	25	91	101.3
额定参数Rated Parameters	IEC	UL	
额定电压Rated Voltage [V]	1000	600	
额定电流Rated Current [A]	232	200	
接线容量Wire Range	刚性Solid	柔性Fine Stranded	带冷压头Furrule
[mm²]	25-95	25-95	25-95
[AWG]	4-4/0	4-4/0	4-4/0
螺钉类型Screw Type [*]	*		
扭矩Torque [N.m]	*		
其余参数Other Parameters	绝缘材料/阻燃等级, 符合UL94 Insulating Material / Flame Retardant Grade, Conforming To UL94		
剥线长度Strip length [mm]	35		

订货信息Order Information

产品Product	颜色Colour	订货号Order NO.
适配NS 35/7.5导轨 Can Be Used For DIN Rail NS 35/7.5	灰Gray	TAPO95-2-PE
	*	*
	*	*

配套附件Accessory

端板Cover Plate	颜色Colour	订货号Order NO.
端板Cover Plate	灰Gray	*
	橙Orange	*

跨接件Jumper

位数Poles No.	订货号Order NO.
2	TJEB25-2
3	*
4	*
...
9	*
10	*

正面标记(小)Front Marker(Small)

可提供印字服务Printing Service *

正面标记(大)Front Marker(Big)

可提供印字服务Printing Service 225801



6mm²,等电位分线插头
Power distribution plug

技术参数Technical Parameter

尺寸Size	厚度Thickness	宽度Width	高度Height
注: 安装NS35/7.5导轨后的高度 Note: Height With DIN Rail NS 35/7.5	16		
额定参数Rated Parameters	IEC	UL	
额定电压Rated Voltage [V]	1000	600	
额定电流Rated Current [A]	41	30	
接线容量Wire Range	刚性Solid	柔性Fine Stranded	带冷压头Furrule
[mm²]	0.2-6	0.2-6	0.2-6
[AWG]	24-10	24-10	24-10
螺钉类型Screw Type [*]	*		
扭矩Torque [N.m]	*		
其余参数Other Parameters	绝缘材料/阻燃等级, 符合UL94 Insulating Material / Flame Retardant Grade, Conforming To UL94		
剥线长度Strip length [mm]	12-13		

订货信息Order Information

产品Product	颜色Colour	订货号Order NO.
适配NS 35/7.5导轨 Can Be Used For DIN Rail NS 35/7.5	灰Gray	TAAG6-2-GY
	*	*
	*	*

配套附件Accessory

端板Cover Plate	颜色Colour	订货号Order NO.
端板Cover Plate	灰Gray	*
	橙Orange	*

跨接件Jumper

位数Poles No.	订货号Order NO.
2	*
3	*
4	*
...
9	*
10	*

正面标记(小)Front Marker(Small)

可提供印字服务Printing Service *

正面标记(大)Front Marker(Big)

可提供印字服务Printing Service 225801



10mm²,等电位分线插头
Power distribution plug

技术参数Technical Parameter

尺寸Size	厚度Thickness	宽度Width	高度Height
注: 安装NS35/7.5导轨后的高度 Note: Height With DIN Rail NS 35/7.5	20	68.3	34
额定参数Rated Parameters	IEC	UL	
额定电压Rated Voltage [V]	1000	600	
额定电流Rated Current [A]	57	50	
接线容量Wire Range	刚性Solid	柔性Fine Stranded	带冷压头Furrule
[mm²]	0.2-16	0.2-16	0.2-16
[AWG]	24-8	24-8	24-8
螺钉类型Screw Type [*]	*		
扭矩Torque [N.m]	*		
其余参数Other Parameters	绝缘材料/阻燃等级, 符合UL94 Insulating Material / Flame Retardant Grade, Conforming To UL94		
剥线长度Strip length [mm]	12-13		

订货信息Order Information

产品Product	颜色Colour	订货号Order NO.
适配NS 35/7.5导轨 Can Be Used For DIN Rail NS 35/7.5	灰Gray	TAAG10-2-GY
	*	*
	*	*

配套附件Accessory

端板Cover Plate	颜色Colour	订货号Order NO.
端板Cover Plate	灰Gray	*
	橙Orange	*

跨接件Jumper

位数Poles No.	订货号Order NO.
2	*
3	*
4	*
...
9	*
10	*

正面标记(小)Front Marker(Small)

可提供印字服务Printing Service *

正面标记(大)Front Marker(Big)

可提供印字服务Printing Service 225801

TC系列弹簧接线端子

TC Rail-mounted Terminal Blocks With Spring-cage Clamp

TC系列弹簧接线端子采用笼式弹簧接线技术，具有节约空间的设计和最优接线方案两大特点。产品广泛应用于电梯、轨道交通、船舶、楼宇智能、重型设备及工业自动化等领域。产品设计制造符合IEC/EN60947、UL1059等相关国际标准。

TC series spring-cage terminal blocks adopt spring cage technology, which have 2 advantages, one is saving design space and the other one is best wire connection solution. The products can be widely used in elevator, rail way industry, ship building, building wire, heavy duty equipment, automation industry etc. The product design and manufacturing in line with relevant international standards such as IEC60947, UL1059.

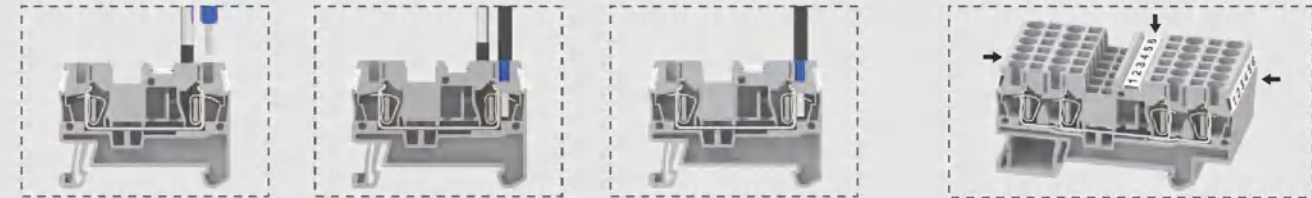
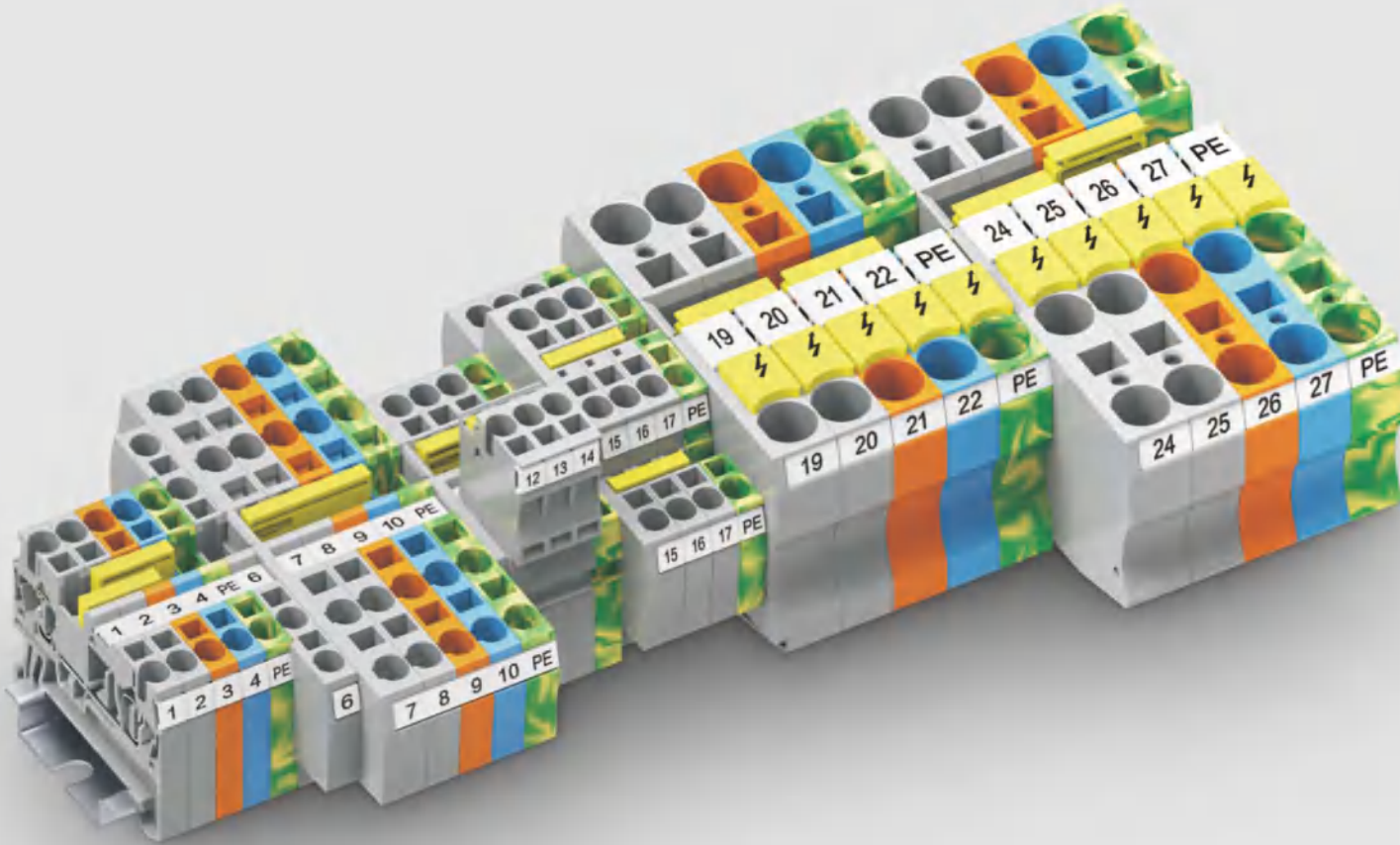

- ▲ 采用笼式弹簧接线技术，拥有更大的锁线力，能保证端子在震动环境中长期稳定的工作。
- ▲ 使用标准螺丝刀打开弹簧后将导线插入接线孔内，移除螺丝刀口即完成接线工作。
- ▲ 产品不单可接额定接线范围的软硬线，也可接额定接线范围带绝缘管冷压头，最大接线容量可达35mm²。
- ▲ Spring-cage connection technology has more locking force, which makes sure steady working in vibration surrounding.
- ▲ Easy operation: open the spring by screwdriver, insert wire. It's done when removing the screw driver.
- ▲ It's workable not only for solid or flexible wire by the rated cross section, but also for wire with furrule by the rated cross section. Max wire cross section is 35mm².

- 标识 Marking
- ▲ 采用三侧标识位设计，可在多个角度位置观察到端子标识，方便操作。
 - ▲ The marker are designed by 3 sides to make it easy to be observed, which makes operation easier.

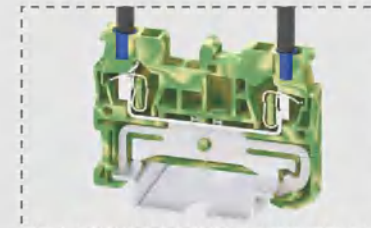

- 接地端子 Ground Terminal Block
- ▲ 使用黄绿色绝缘外壳，尺寸外形与接线端子相同。
 - ▲ 端子满足IEC60947-7-2标准中的要求。
 - ▲ Used the green-yellow insulation shell, the dimension is same as terminal blocks.
 - ▲ Approval for IEC 60947-7-2.

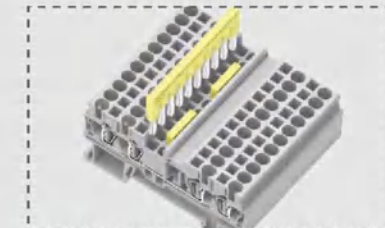

- 跨接系统 Jumper System
- ▲ 采用双排跨接槽设计，跨接件最多可达10极，可实现多种复杂的电路设计。
 - ▲ Adopting double row jumper slot design, the jumper can reach up to 10 pins at most, can achieve many kinds of complicated circuit design.

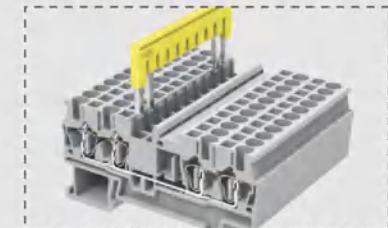

- 跨接 Staggered Jumper
- ▲ 折断跨接间的金属齿，可实现不相邻端子间的跨接。
 - ▲ The adjacent poles can be connected by breaking down the comb's pin.

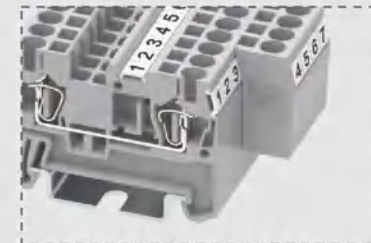

- 补偿端板 Compensatory Plate
- ▲ 不同位数端子并排拼接时，补偿端板可封闭裸露的载流体与夹零件。
 - ▲ The compensatory plates can be used to pretend from conductor parts when different poles terminal blocks assemble.

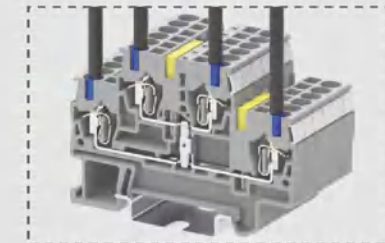

- 双层接线端子 Double-level Feed Through Terminal Block
- ▲ 双层端子上下两层即可实现独立工作也可实现两层间相互连接，其优点在于的空间内相比较传统两进两出端子长度大大节省。
 - ▲ 双层端子的标识系统、跨接系统等附件可与TC系列产品共用。
 - ▲ The up or down level can work separately or connected. It can connect more wires in same length than 2-2 terminal blocks.
 - ▲ It shares the accessory like markers jumpers with TC series.

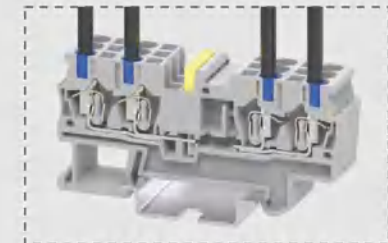

- 两进两出分断式接线端子 2-2 Feed Through Terminal Block With Interrupted Power Rail
- ▲ 两进两出分断式端子相较两进两出接线端子其载流体为中间断开结构，在同一端子的左右两侧实现两个独立的电位。
 - ▲ 一侧电位可使用跨接桥进行多位置桥接件与夹零件。
 - ▲ The conduction part is divided in middle compared to normal 2-2 terminal blocks. Which can get 2 individual circuits on a terminal block both sides.
 - ▲ And bridges can connected at random on one side.

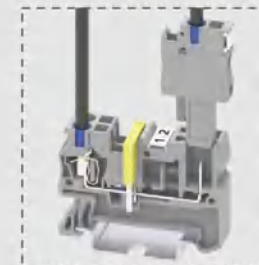

插拔式接线端子 Pluggable Terminal Block

- ▲ 带插拔功能接线端子将TC回拉式弹簧接线端子与插头相结合，提供了灵活的连接方式。
- ▲ 插头与插座都带有防触电保护，端子与插头都可接入电源。
- ▲ 插头可实现单根导线连接、两根导线连接，还可实现跨接件连接多位插头。
- ▲ 插头可被客户需求提供多位数，最高可达15位，并且提供灰、蓝、橙、黄-绿多种颜色。
- ▲ It joins from TC spring-cage connection terminal blocks and plug. Which get flexible connection solution.
- ▲ Both Plug-in and plug parts are protection against electric shock. Both can be connected to electricity.
- ▲ Plug can be connected by single or double wires. Or multi plugs connected by bridges.
- ▲ Plug can be provided from 2-15 poles. And gray, blue, orange, yellow-green colors are available.

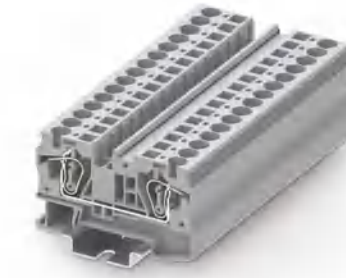
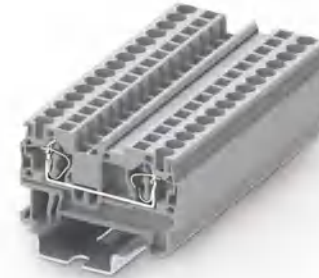
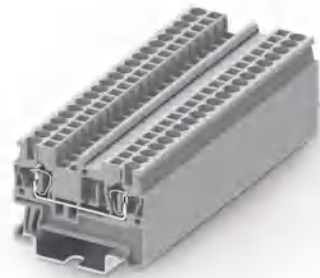
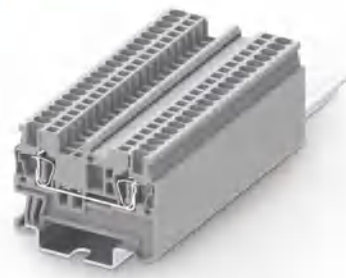

	1.5mm ² 一进一出接线端子 1-1 Feed Through Terminal Block			2.5mm ² 一进一出接线端子 1-1 Feed Through Terminal Block			4mm ² 一进一出接线端子 1-1 Feed Through Terminal Block			6mm ² 一进一出接线端子 1-1 Feed Through Terminal Block			10mm ² 一进一出接线端子 1-1 Feed Through Terminal Block				
	技术参数Technical Parameter			技术参数Technical Parameter			技术参数Technical Parameter			技术参数Technical Parameter			技术参数Technical Parameter				
尺寸Size	厚度Thickness	宽度Width	高度Height	厚度Thickness	宽度Width	高度Height	厚度Thickness	宽度Width	高度Height	厚度Thickness	宽度Width	高度Height	厚度Thickness	宽度Width	高度Height		
注: 安装NS35/7.5导轨后的高度 Note: Height With DIN Rail NS 35/7.5	4.2	48.2	36.8	5.2	48.2	36.8	6.2	56.2	36.8	8.2	69.5	43.5	10.2	71.5	49.6		
额定电压Rated Voltage [V]	IEC	UL		IEC	UL		IEC	UL		IEC	UL		IEC	UL			
额定电流Rated Current [A]	500	300		800	600		800	600		1000	600		1000	600			
接线容量Wire Range [mm ²]	17.5	15		24	20		32	30		41	50		57	65			
接线容量Wire Range [AWG]	刚性Solid	柔性Fine Stranded	带冷压头Furrule	刚性Solid	柔性Fine Stranded	带冷压头Furrule	刚性Solid	柔性Fine Stranded	带冷压头Furrule	刚性Solid	柔性Fine Stranded	带冷压头Furrule	刚性Solid	柔性Fine Stranded	带冷压头Furrule		
	0.2-1.5	0.2-1.5	0.2-1.5	0.2-4	0.2-2.5	0.2-2.5	0.2-6	0.2-4	0.2-4	0.2-10	0.2-6	0.2-6	0.2-16	0.2-10	0.2-10		
	24-16	24-16	24-16	24-12	24-12	24-12	24-10	24-10	24-10	24-8	24-8	24-8	24-6	24-6	24-6		
其余参数Other Parameters																	
绝缘材料/阻燃等级, 符合UL94 Insulating Material / Flame Retardant Grade, Conforming To UL94	V0			V0			V0			V0			V0				
剥线长度Strip length [mm]	10			10			10			12			18				
订货信息Order Information																	
产品Product	颜色Colour		订货号Order NO.			订货号Order NO.			订货号Order NO.			订货号Order NO.			订货号Order NO.		
适配NS 35/7.5 NS 35/15导轨 Can Be Used For DIN Rail NS 35/7.5 NS35/15	灰Gray		TC1.5-2-GY			TC2.5-2-GY			TC4-2-GY			TC6-2-GY			TC10-2-GY		
	橙Orange		TC1.5-2-OG			TC2.5-2-OG			TC4-2-OG			TC6-2-OG			TC10-2-OG		
	蓝Blue		TC1.5-2-BU			TC2.5-2-BU			TC4-2-BU			TC6-2-BU			TC10-2-BU		
配套附件Accessory																	
端板Cover Plate	颜色Colour		订货号Order NO.			订货号Order NO.			订货号Order NO.			订货号Order NO.			订货号Order NO.		
厚度2.2mm Thickness2.2mm	灰Gray		TC1.5-2-GY-EA			TC1.5-2-GY-EA			TC4-2-GY-EA			TC6-2-GY-EA			TC10-2-GY-EA		
	橙Orange		TC1.5-2-OG-EA			TC1.5-2-OG-EA			TC4-2-OG-EA			TC6-2-OG-EA			TC10-2-OG-EA		
	蓝Blue		TC1.5-2-BU-EA			TC1.5-2-BU-EA			TC4-2-BU-EA			TC6-2-BU-EA			TC10-2-BU-EA		
补偿端板Compensatory Plate	颜色Colour		订货号Order NO.			订货号Order NO.			订货号Order NO.			订货号Order NO.			订货号Order NO.		
厚度1.00mm Thickness1.00mm	灰Gray		TC1.5-4-GY-EB			TC1.5-4-GY-EB			TC4-4-GY-EB			*			*		
跨接件Jumper	颜色Colour		Imax/17.5A			Imax/24A			Imax/32A			Imax/41A			Imax/57A		
位数Poles No.	颜色Colour		订货号Order NO.			订货号Order NO.			订货号Order NO.			订货号Order NO.			订货号Order NO.		
2	黄Yellow		TJA4.2-2			TJA5.2-2			TJA6.2-2			TJA8.2-2			TJA10.2-2		
3	黄Yellow		TJA4.2-3			TJA5.2-3			TJA6.2-3			TJA8.2-3			*		
4	黄Yellow		TJA4.2-4			TJA5.2-4			TJA6.2-4			TJA8.2-4			*		
...		
9	黄Yellow		TJA4.2-9			TJA5.2-9			TJA6.2-9			TJA8.2-9			*		
10	黄Yellow		TJA4.2-10			TJA5.2-10			TJA6.2-10			TJA8.2-10			*		
安全警告标记 Protective Warning Marker	颜色Colour		订货号Order NO.			订货号Order NO.			订货号Order NO.			订货号Order NO.			订货号Order NO.		
5位PCS			TMD4.2-5			TMD5.2-5			TMD6.2-5			TMD8.2-5			TMD10.2-5		
正面标记Front Marker	颜色Colour		订货号Order NO.			订货号Order NO.			订货号Order NO.			订货号Order NO.			订货号Order NO.		
10位PCS			*			305801			306801			308801			TMB10.2-10		
正面标记和侧面标记Front And Side Marker	颜色Colour		订货号Order NO.			订货号Order NO.			订货号Order NO.			订货号Order NO.			订货号Order NO.		
可提供印字服务Printing Service			TMB4.2-100			TMB5.2-120			TMB6.2-100			TMB8.2-50			TMB8.2-50		

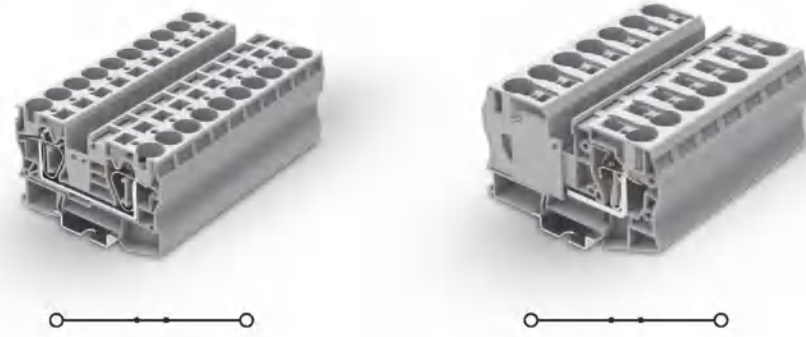

16mm² 一进一出接线端子
1-1 Feed Through Terminal Block

35mm² 一进一出接线端子
1-1 Feed Through Terminal Block

尺寸Size	
注: 安装NS35/7.5导轨后的高度 Note: Height With DIN Rail NS 35/7.5	[mm]
额定参数Rated Parameters	
额定电压Rated Voltage	[V]
额定电流Rated Current	[A]
接线容量Wire Range	
	[mm²]
	[AWG]
其余参数Other Parameters	
绝缘材料/阻燃等级, 符合UL94 Insulating Material / Flame Retardant Grade, Conforming To UL94	
剥线长度Strip length	[mm]

技术参数Technical Parameter		
厚度Thickness	宽度Width	高度Height
12.2	80	51.5
IEC	UL	
1000	600	
76	85	
接线容量Wire Range		
刚性Solid	柔性Fine Stranded	带冷压头Furrule
0.2-25	0.2-16	0.25-16
24-4	24-4	24-4
其余参数Other Parameters		
	V0	
	18	

技术参数Technical Parameter		
厚度Thickness	宽度Width	高度Height
16.1	100	59
IEC	UL	
1000	600	
125	115	
接线容量Wire Range		
刚性Solid	柔性Fine Stranded	带冷压头Furrule
2.5-35	2.5-35	2.5-35
14-2	14-2	14-2
其余参数Other Parameters		
	V0	
	25	

产品Product		颜色Colour
适配NS 35/7.5 NS 35/15导轨 Can Be Used For DIN Rail NS 35/7.5 NS35/15		灰Gray
		橙Orange
		蓝Blue

订货信息Order Information	
产品Product	颜色Colour
适配NS 35/7.5 NS 35/15导轨 Can Be Used For DIN Rail NS 35/7.5 NS35/15	灰Gray
	橙Orange
	蓝Blue

订货信息Order Information	
产品Product	颜色Colour
适配NS 35/7.5 NS 35/15导轨 Can Be Used For DIN Rail NS 35/7.5 NS35/15	灰Gray
	橙Orange
	蓝Blue

端板Cover Plate	
厚度2.2mm Thickness2.2mm	灰Gray
	橙Orange
	蓝Blue

配套附件Accessory	
端板Cover Plate	厚度Thickness
灰Gray	2.2mm
橙Orange	2.2mm
蓝Blue	2.2mm

配套附件Accessory	
端板Cover Plate	厚度Thickness
灰Gray	2.2mm
橙Orange	2.2mm
蓝Blue	2.2mm

补偿端板Compensatory Plate	
厚度1.00mm Thickness1.00mm	灰Gray

补偿端板Compensatory Plate	
厚度Thickness	颜色Colour
1.00mm	灰Gray

补偿端板Compensatory Plate	
厚度Thickness	颜色Colour
1.00mm	灰Gray

跨接件Jumper	
位数Poles No.	颜色Colour
2	黄Yellow
3	黄Yellow
4	黄Yellow
...
9	黄Yellow
10	黄Yellow

跨接件Jumper	
位数Poles No.	颜色Colour
2	黄Yellow
3	黄Yellow
4	黄Yellow
...
9	黄Yellow
10	黄Yellow

跨接件Jumper	
位数Poles No.	颜色Colour
2	黄Yellow
3	黄Yellow
4	黄Yellow
...
9	黄Yellow
10	黄Yellow

安全警告标记 Protective Warning Marker	
5位PCS	TMD10.2-5
正面标记Front Marker	10位PCS
正面标记和侧面标记Front And Side Marker	可提供印字服务Printing Service

安全警告标记 Protective Warning Marker	
5位PCS	TMD10.2-5
正面标记Front Marker	10位PCS
正面标记和侧面标记Front And Side Marker	可提供印字服务Printing Service

安全警告标记 Protective Warning Marker	
5位PCS	TMD10.2-5
正面标记Front Marker	10位PCS
正面标记和侧面标记Front And Side Marker	可提供印字服务Printing Service

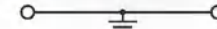
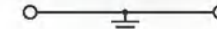
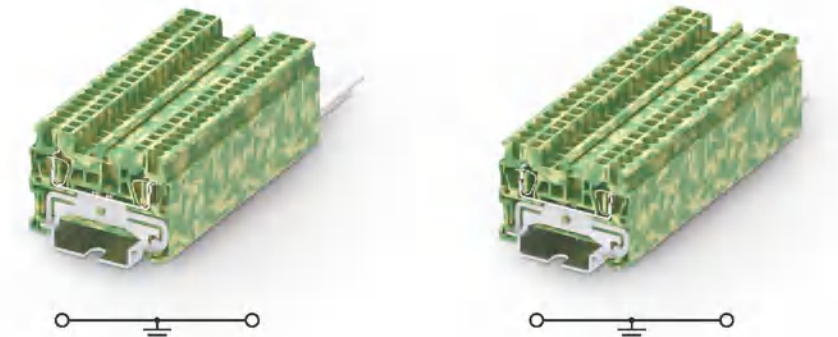

1.5mm² 一进一出接地端子
1-1 Feed Through Ground Terminal Block

2.5mm² 一进一出接地端子
1-1 Feed Through Ground Terminal Block

尺寸Size	
注: 安装NS35/7.5导轨后的高度 Note: Height With DIN Rail NS 35/7.5	[mm]
额定参数Rated Parameters	
额定电压Rated Voltage	[V]
额定电流Rated Current	[A]
接线容量Wire Range	
	[mm²]
	[AWG]
其余参数Other Parameters	
绝缘材料/阻燃等级, 符合UL94 Insulating Material / Flame Retardant Grade, Conforming To UL94	
剥线长度Strip length	[mm]

技术参数Technical Parameter		
厚度Thickness	宽度Width	高度Height
4.2	48.2	36.8
IEC	UL	
500	300	
*	*	
接线容量Wire Range		
刚性Solid	柔性Fine Stranded	带冷压头Furrule
0.2-1.5	0.2-1.5	0.2-1.5
24-16	24-16	24-16
其余参数Other Parameters		
	V0	
	10	

技术参数Technical Parameter		
厚度Thickness	宽度Width	高度Height
5.2	48.2	36.8
IEC	UL	
800	600	
*	*	
接线容量Wire Range		
刚性Solid	柔性Fine Stranded	带冷压头Furrule
0.2-4	0.2-2.5	0.2-2.5
24-12	24-12	24-12
其余参数Other Parameters		
	V0	
	10	

产品Product		颜色Colour
适配NS 35/7.5 NS 35/15导轨 Can Be Used For DIN Rail NS 35/7.5 NS35/15		黄Yellow green
		*
		*

订货信息Order Information	
产品Product	颜色Colour
适配NS 35/7.5 NS 35/15导轨 Can Be Used For DIN Rail NS 35/7.5 NS35/15	黄Yellow green
	*
	*

订货信息Order Information	
产品Product	颜色Colour
适配NS 35/7.5 NS 35/15导轨 Can Be Used For DIN Rail NS 35/7.5 NS35/15	黄Yellow green
	*
	*

端板Cover Plate	
厚度2.2mm Thickness2.2mm	灰Gray
	橙Orange
	蓝Blue

端板Cover Plate	
厚度Thickness	颜色Colour
2.2mm	灰Gray
	橙Orange
	蓝Blue

端板Cover Plate	
厚度Thickness	颜色Colour
2.2mm	灰Gray
	橙Orange
	蓝Blue

补偿端板Compensatory Plate	
厚度1.00mm Thickness1.00mm	灰Gray

补偿端板Compensatory Plate	
厚度Thickness	颜色Colour
1.00mm	灰Gray

补偿端板Compensatory Plate	
厚度Thickness	颜色Colour
1.00mm	灰Gray

跨接件Jumper	
位数Poles No.	颜色Colour
2	黄Yellow
3	黄Yellow
4	黄Yellow
...
9	黄Yellow
10	黄Yellow

跨接件Jumper	
位数Poles No.	颜色Colour
2	黄Yellow
3	黄Yellow
4	黄Yellow
...
9	黄Yellow
10	黄Yellow

跨接件Jumper	
位数Poles No.	颜色Colour
2	黄Yellow
3	黄Yellow
4	黄Yellow
...
9	黄Yellow
10	黄Yellow

安全警告标记 Protective Warning Marker	
5位PCS	TMD4.2-5
正面标记Front Marker	10位PCS
正面标记和侧面标记Front And Side Marker	可提供印字服务Printing Service

安全警告标记 Protective Warning Marker	
5位PCS	TMD4.2-5
正面标记Front Marker	10位PCS
正面标记和侧面标记Front And Side Marker	可提供印字服务Printing Service

安全警告标记 Protective Warning Marker	
5位PCS	TMD5.2-5
正面标记Front Marker	305801
正面标记和侧面标记Front And Side Marker	可提供印字服务Printing Service

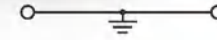
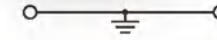
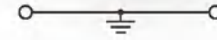
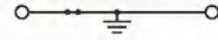
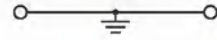

4mm² 一进一出接地端子
1-1 Feed Through Ground Terminal Block

6mm² 一进一出接地端子
1-1 Feed Through Ground Terminal Block

10mm² 一进一出接地端子
1-1 Feed Through Ground Terminal Block

16mm² 一进一出接地端子
1-1 Feed Through Ground Terminal Block

35mm² 一进一出接地端子
1-1 Feed Through Ground Terminal Block

尺寸Size	
注: 安装NS35/7.5导轨后的高度 Note: Height With DIN Rail NS 35/7.5	[mm]
额定电压Rated Voltage	[V]
额定电流Rated Current	[A]
接线容量Wire Range	
	[mm ²]
	[AWG]
其余参数Other Parameters	
绝缘材料/阻燃等级, 符合UL94 Insulating Material / Flame Retardant Grade, Conforming To UL94	
剥线长度Strip length	[mm]

技术参数Technical Parameter		
厚度Thickness	宽度Width	高度Height
6.2	56.2	36.8
IEC	UL	
800	600	
*	*	
接线容量Wire Range		
刚性Solid	柔性Fine Stranded	带冷压头Furrule
0.2-6	0.2-4	0.2-4
24-10	24-10	24-10
其余参数Other Parameters		
	V0	
	10	

技术参数Technical Parameter		
厚度Thickness	宽度Width	高度Height
8.2	69.5	43.5
IEC	UL	
1000	600	
*	*	
接线容量Wire Range		
刚性Solid	柔性Fine Stranded	带冷压头Furrule
0.2-10	0.2-6	0.2-6
24-8	24-8	24-8
其余参数Other Parameters		
	V0	
	12	

技术参数Technical Parameter		
厚度Thickness	宽度Width	高度Height
10.2	71.5	49.6
IEC	UL	
800	600	
*	*	
接线容量Wire Range		
刚性Solid	柔性Fine Stranded	带冷压头Furrule
0.2-16	0.2-10	0.2-10
24-6	24-6	24-6
其余参数Other Parameters		
	V0	
	18	

技术参数Technical Parameter		
厚度Thickness	宽度Width	高度Height
12.2	80	51.5
IEC	UL	
1000	600	
*	*	
接线容量Wire Range		
刚性Solid	柔性Fine Stranded	带冷压头Furrule
0.2-25	0.2-16	0.25-16
24-4	24-4	24-4
其余参数Other Parameters		
	V0	
	18	

技术参数Technical Parameter		
厚度Thickness	宽度Width	高度Height
16.1	100	59
IEC	UL	
1000	600	
*	*	
接线容量Wire Range		
刚性Solid	柔性Fine Stranded	带冷压头Furrule
2.5-35	2.5-35	2.5-35
14-2	14-2	14-2
其余参数Other Parameters		
	V0	
	25	

产品信息Product	
颜色Colour	黄绿Yellow green
适配NS 35/7.5 NS 35/15导轨 Can Be Used For DIN Rail NS 35/7.5 NS35/15	*

订货信息Order Information	
订货号Order NO.	TC4-2-PE
	*
	*

订货信息Order Information	
订货号Order NO.	TC6-2-PE
	*
	*

订货信息Order Information	
订货号Order NO.	TC10-2-PE
	*
	*

订货信息Order Information	
订货号Order NO.	TC16-2-PE
	*
	*

订货信息Order Information	
订货号Order NO.	TC35-2-PE
	*
	*

配套附件Accessory	
端板Cover Plate	灰Gray
厚度2.2mm Thickness2.2mm	橙Orange
	蓝Blue
补偿端板Compensatory Plate	灰Gray
厚度1.00mm Thickness1.00mm	
跨接件Jumper	
位数Poles No.	颜色Colour
2	黄Yellow
3	黄Yellow
4	黄Yellow
...
9	黄Yellow
10	黄Yellow
安全警告标记 Protective Warning Marker	
5位PCS	
正面标记Front Marker	
10位PCS	
正面标记和侧面标记Front And Side Marker	
可提供印字服务Printing Service	

配套附件Accessory	
订货号Order NO.	TC4-2-GY-EA
	TC4-2-OG-EA
	TC4-2-BU-EA
订货号Order NO.	TC4-4-GY-EB
	*
订货号Order NO.	
	*
	*
	*
	*
	*
订货号Order NO.	TMD6.2-5
订货号Order NO.	306801
订货号Order NO.	TMB6.2-100

配套附件Accessory	
订货号Order NO.	TC6-2-GY-EA
	TC6-2-OG-EA
	TC6-2-BU-EA
订货号Order NO.	*
订货号Order NO.	
	TJA8.2-2
	TJA8.2-3
	TJA8.2-4

	TJA8.2-9
	TJA8.2-10
订货号Order NO.	TMD8.2-5
订货号Order NO.	308801
订货号Order NO.	TMB8.2-50

配套附件Accessory	
订货号Order NO.	TC10-2-GY-EA
	TC10-2-OG-EA
	TC10-2-BU-EA
订货号Order NO.	TC10-4-GY-EB
	*
订货号Order NO.	
	*
	*
	*
	*
	*
订货号Order NO.	TMD10.2-5
订货号Order NO.	310801
订货号Order NO.	TMB10.2-10

配套附件Accessory	
订货号Order NO.	TC16-2-GY-EA
	TC16-2-OG-EA
	TC16-2-BU-EA
订货号Order NO.	*
订货号Order NO.	
	*
	*
	*
	*
	*
订货号Order NO.	TMD10.2-5
订货号Order NO.	TMB10.2-10
订货号Order NO.	TMB8.2-50

配套附件Accessory	
订货号Order NO.	*
	*
	*
订货号Order NO.	*
订货号Order NO.	
	*
	*
	*
	*
订货号Order NO.	TMD10.2-5
订货号Order NO.	TMB10.2-10
订货号Order NO.	TMB8.2-50

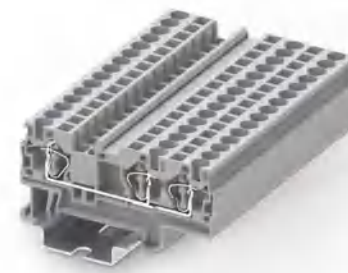
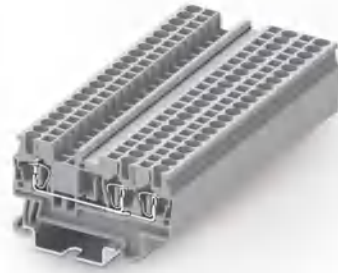
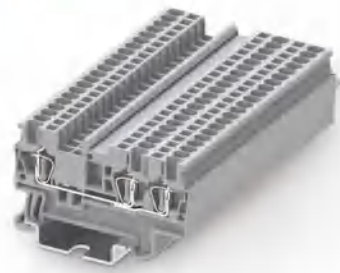

1.5mm² 一进两出接线端子
1.5mm² 1-2 Feed Through Terminal Block

2.5mm² 一进两出接线端子
2.5mm² 1-2 Feed Through Terminal Block

4mm² 一进两出接线端子
1-2 Feed Through Terminal Block

6mm² 一进两出接线端子
1-2 Feed Through Terminal Block

10mm² 一进两出接线端子
1-2 Feed Through Terminal Block

尺寸Size	
注: 安装NS35/7.5导轨后的高度 Note: Height With DIN Rail NS 35/7.5	[mm]
额定电压Rated Voltage	[V]
额定电流Rated Current	[A]
接线容量Wire Range	[mm ²] [AWG]
其余参数Other Parameters	
绝缘材料/阻燃等级, 符合UL94 Insulating Material / Flame Retardant Grade, Conforming To UL94	
剥线长度Strip length	[mm]

技术参数Technical Parameter		
厚度Thickness	宽度Width	高度Height
4.2	60.2	36.8
IEC	UL	
500	300	
17.5	15	
刚性Solid	柔性Fine Stranded	带冷压头Furrule
0.2-1.5	0.2-1.5	0.2-1.5
24-16	24-16	24-16
V0		
10		

技术参数Technical Parameter		
厚度Thickness	宽度Width	高度Height
5.2	60.2	36.8
IEC	UL	
800	600	
24	20	
刚性Solid	柔性Fine Stranded	带冷压头Furrule
0.2-4	0.2-2.5	0.2-2.5
24-12	24-12	24-12
V0		
10		

技术参数Technical Parameter		
厚度Thickness	宽度Width	高度Height
6.2	71.8	36.8
IEC	UL	
800	600	
32	30	
刚性Solid	柔性Fine Stranded	带冷压头Furrule
0.2-6	0.2-4	0.2-4
24-10	24-10	24-10
V0		
10		

技术参数Technical Parameter		
厚度Thickness	宽度Width	高度Height
8.2	90.5	43.5
IEC	UL	
1000	600	
41	50	
刚性Solid	柔性Fine Stranded	带冷压头Furrule
0.2-10	0.2-6	0.2-6
24-8	24-8	24-8
V0		
12		

技术参数Technical Parameter		
厚度Thickness	宽度Width	高度Height
10.2	97	50.4
IEC	UL	
1000	600	
57	65	
刚性Solid	柔性Fine Stranded	带冷压头Furrule
0.2-16	0.2-10	0.2-10
24-6	24-6	24-6
V0		
18		

产品信息Product	
颜色Colour	灰Gray 橙Orange 蓝Blue
适配NS 35/7.5 NS 35/15导轨 Can Be Used For DIN Rail NS 35/7.5 NS35/15	

订货信息Order Information	
订货号Order NO.	TC1.5-3-GY TC1.5-3-OG TC1.5-3-BU

订货信息Order Information	
订货号Order NO.	TC2.5-3-GY TC2.5-3-OG TC2.5-3-BU

订货信息Order Information	
订货号Order NO.	TC4-3-GY TC4-3-OG TC4-3-BU

订货信息Order Information	
订货号Order NO.	TC6-3-GY TC6-3-OG TC6-3-BU

订货信息Order Information	
订货号Order NO.	TC10-3-GY TC10-3-OG TC10-3-BU

配套附件Accessory	
盖板Cover Plate	灰Gray 橙Orange 蓝Blue
厚度2.2mm Thickness2.2mm	
补偿盖板Compensatory Plate	灰Gray
厚度1.00mm Thickness1.00mm	
跨接件Jumper	黄Yellow
位数Poles No.	黄Yellow
2	黄Yellow
3	黄Yellow
4	黄Yellow
...
9	黄Yellow
10	黄Yellow
安全警告标记 Protective Warning Marker	
5位PCS	
正面标记Front Marker	
10位PCS	
正面标记和侧面标记Front And Side Marker	
可提供印字服务Printing Service	

配套附件Accessory	
订货号Order NO.	TC1.5-3-GY-EA TC1.5-3-OG-EA TC1.5-3-BU-EA
订货号Order NO.	TC1.5-4-GY-EB
Imax/17.5A	
订货号Order NO.	TJA4.2-2 TJA4.2-3 TJA4.2-4 TJA4.2-9 TJA4.2-10
订货号Order NO.	TMD4.2-5
订货号Order NO.	*
订货号Order NO.	TMB4.2-100

配套附件Accessory	
订货号Order NO.	TC1.5-3-GY-EA TC1.5-3-OG-EA TC1.5-3-BU-EA
订货号Order NO.	TC1.5-4-GY-EB
Imax/24A	
订货号Order NO.	TJA5.2-2 TJA5.2-3 TJA5.2-4 TJA5.2-9 TJA5.2-10
订货号Order NO.	TMD5.2-5
订货号Order NO.	305801
订货号Order NO.	TMB5.2-120

配套附件Accessory	
订货号Order NO.	TC4-3-GY-EA TC4-3-OG-EA TC4-3-BU-EA
订货号Order NO.	TC4-4-GY-EB
Imax/32A	
订货号Order NO.	TJA6.2-2 TJA6.2-3 TJA6.2-4 TJA6.2-9 TJA6.2-10
订货号Order NO.	TMD6.2-5
订货号Order NO.	306801
订货号Order NO.	TMB6.2-100

配套附件Accessory	
订货号Order NO.	TC6-3-GY-EA TC6-3-OG-EA TC6-3-BU-EA
订货号Order NO.	*
Imax/41A	
订货号Order NO.	TJA8.2-2 TJA8.2-3 TJA8.2-4 TJA8.2-9 TJA8.2-10
订货号Order NO.	TMD8.2-5
订货号Order NO.	308801
订货号Order NO.	TMB8.2-50

配套附件Accessory	
订货号Order NO.	TC10-3-GY-EA TC10-3-OG-EA TC10-3-BU-EA
订货号Order NO.	*
Imax/57A	
订货号Order NO.	TJA10.2-2 * * *
订货号Order NO.	TMD10.2-5
订货号Order NO.	TMB10.2-10
订货号Order NO.	TMB8.2-50

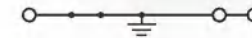
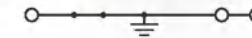
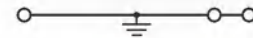
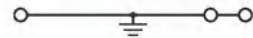
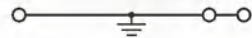
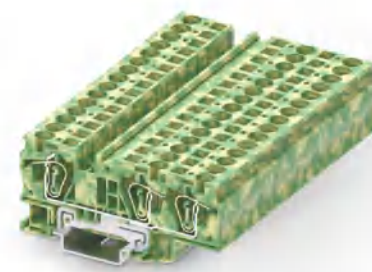
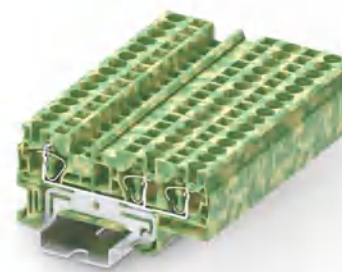
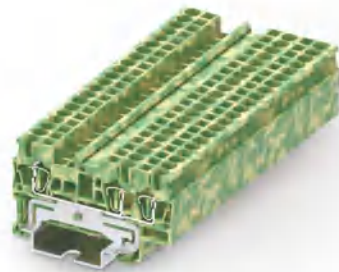
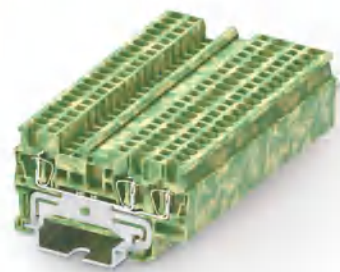

1.5mm² 一进两出接地端子
1-2 Feed Through Ground Terminal Block

2.5mm² 一进两出接地端子
1-2 Feed Through Ground Terminal Block

4mm² 一进两出接地端子
1-2 Feed Through Ground Terminal Block

6mm² 一进两出接地端子
1-2 Feed Through Ground Terminal Block

10mm² 一进两出接地端子
1-2 Feed Through Ground Terminal Block

尺寸Size	
注: 安装NS35/7.5导轨后的高度 Note: Height With DIN Rail NS 35/7.5	[mm]
额定电压Rated Voltage	[V]
额定电流Rated Current	[A]
接线容量Wire Range	[mm ²] [AWG]
其余参数Other Parameters	
绝缘材料/阻燃等级, 符合UL94 Insulating Material / Flame Retardant Grade, Conforming To UL94	
剥线长度Strip length	[mm]

技术参数Technical Parameter		
厚度Thickness	宽度Width	高度Height
4.2	60.2	36.8
IEC	UL	
500	300	
*	*	
刚性Solid	柔性Fine Stranded	带冷压头Furrule
0.2-1.5	0.2-1.5	0.2-1.5
24-16	24-16	24-16

技术参数Technical Parameter		
厚度Thickness	宽度Width	高度Height
5.2	60.2	36.8
IEC	UL	
800	600	
*	*	
刚性Solid	柔性Fine Stranded	带冷压头Furrule
0.2-4	0.2-2.5	0.2-2.5
24-12	24-12	24-12

技术参数Technical Parameter		
厚度Thickness	宽度Width	高度Height
6.2	71.8	36.8
IEC	UL	
800	600	
*	*	
刚性Solid	柔性Fine Stranded	带冷压头Furrule
0.2-6	0.2-4	0.2-4
24-10	24-10	24-10

技术参数Technical Parameter		
厚度Thickness	宽度Width	高度Height
8.2	90.5	43.5
IEC	UL	
1000	600	
*	*	
刚性Solid	柔性Fine Stranded	带冷压头Furrule
0.2-10	0.2-6	0.2-6
24-8	24-8	24-8

技术参数Technical Parameter		
厚度Thickness	宽度Width	高度Height
10.2	97	50.4
IEC	UL	
1000	600	
*	*	
刚性Solid	柔性Fine Stranded	带冷压头Furrule
0.2-16	0.2-10	0.2-10
24-6	24-6	24-6

订货信息Order Information	
产品Product	颜色Colour
适配NS 35/7.5 NS 35/15导轨 Can Be Used For DIN Rail NS 35/7.5 NS35/15	黄Yellow green

订货信息Order Information	
订货号Order NO.	TC1.5-3-PE

订货信息Order Information	
订货号Order NO.	TC2.5-3-PE

订货信息Order Information	
订货号Order NO.	TC4-3-PE

订货信息Order Information	
订货号Order NO.	TC6-3-PE

订货信息Order Information	
订货号Order NO.	TC10-3-PE

配套附件Accessory	
端板Cover Plate	灰Gray
厚度2.2mm Thickness2.2mm	橙Orange
	蓝Blue
补偿端板Compensatory Plate	灰Gray
厚度1.00mm Thickness1.00mm	
跨接件Jumper	
位数Poles No.	颜色Colour
2	黄Yellow
3	黄Yellow
4	黄Yellow
...
9	黄Yellow
10	黄Yellow
安全警告标记 Protective Warning Marker	
5位PCS	
正面标记Front Marker	
10位PCS	
正面标记和侧面标记Front And Side Marker	
可提供印字服务Printing Service	

配套附件Accessory	
订货号Order NO.	TC1.5-3-GY-EA
	TC1.5-3-OG-EA
	TC1.5-3-BU-EA
订货号Order NO.	TC1.5-4-GY-EB
订货号Order NO.	
订货号Order NO.	
订货号Order NO.	
订货号Order NO.	
订货号Order NO.	
订货号Order NO.	
订货号Order NO.	
订货号Order NO.	
订货号Order NO.	
订货号Order NO.	
订货号Order NO.	
订货号Order NO.	

配套附件Accessory	
订货号Order NO.	TC1.5-3-GY-EA
	TC1.5-3-OG-EA
	TC1.5-3-BU-EA
订货号Order NO.	TC1.5-4-GY-EB
订货号Order NO.	
订货号Order NO.	
订货号Order NO.	
订货号Order NO.	
订货号Order NO.	
订货号Order NO.	
订货号Order NO.	
订货号Order NO.	
订货号Order NO.	
订货号Order NO.	
订货号Order NO.	
订货号Order NO.	

配套附件Accessory	
订货号Order NO.	TC4-3-GY-EA
	TC4-3-OG-EA
	TC4-3-BU-EA
订货号Order NO.	TC4-4-GY-EB
订货号Order NO.	
订货号Order NO.	
订货号Order NO.	
订货号Order NO.	
订货号Order NO.	
订货号Order NO.	
订货号Order NO.	
订货号Order NO.	
订货号Order NO.	
订货号Order NO.	
订货号Order NO.	

配套附件Accessory	
订货号Order NO.	TC6-3-GY-EA
	TC6-3-OG-EA
	TC6-3-BU-EA
订货号Order NO.	*
订货号Order NO.	
订货号Order NO.	
订货号Order NO.	
订货号Order NO.	
订货号Order NO.	
订货号Order NO.	
订货号Order NO.	
订货号Order NO.	
订货号Order NO.	
订货号Order NO.	
订货号Order NO.	

配套附件Accessory	
订货号Order NO.	TC10-3-GY-EA
	TC10-3-OG-EA
	TC10-3-BU-EA
订货号Order NO.	*
订货号Order NO.	
订货号Order NO.	
订货号Order NO.	
订货号Order NO.	
订货号Order NO.	
订货号Order NO.	
订货号Order NO.	
订货号Order NO.	
订货号Order NO.	
订货号Order NO.	
订货号Order NO.	

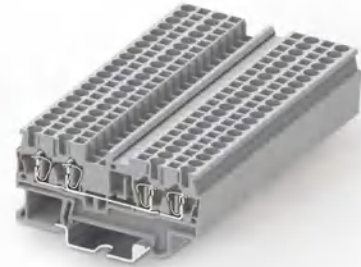

1.5mm² 两进两出接线端子
2-2 Feed Through Terminal Block

2.5mm² 两进两出接线端子
2-2 Feed Through Terminal Block

4mm² 两进两出接线端子
2-2 Feed Through Terminal Block

尺寸Size	
注: 安装NS35/7.5导轨后的高度 Note: Height With DIN Rail NS 35/7.5	[mm]
额定参数Rated Parameters	
额定电压Rated Voltage	[V]
额定电流Rated Current	[A]
接线容量Wire Range	
	[mm ²]
	[AWG]
其余参数Other Parameters	
绝缘材料/阻燃等级, 符合UL94 Insulating Material / Flame Retardant Grade, Conforming To UL94	
剥线长度Strip length	[mm]
产品Product	
颜色Colour	灰Gray
适配NS 35/7.5 NS 35/15导轨 Can Be Used For DIN Rail NS 35/7.5 NS35/15	橙Orange
	蓝Blue
端板Cover Plate	
厚度2.2mm Thickness2.2mm	灰Gray
	橙Orange
	蓝Blue
补偿端板Compensatory Plate	
厚度1.00mm Thickness1.00mm	灰Gray
跨接件Jumper	
位数Poles No.	
	颜色Colour
2	黄Yellow
3	黄Yellow
4	黄Yellow
...	—
9	黄Yellow
10	黄Yellow
安全警告标记 Protective Warning Marker	
5位PCS	
正面标记Front Marker	
10位PCS	
正面标记和侧面标记Front And Side Marker	
可提供印字服务Printing Service	

技术参数Technical Parameter		
厚度Thickness	宽度Width	高度Height
4.2	72.2	36.8
IEC	UL	
500	300	
17.5	15	
刚性Solid	柔性Fine Stranded	带冷压头Furrule
0.2-1.5	0.2-1.5	0.2-1.5
24-16	24-16	24-16
其余参数Other Parameters		
绝缘材料/阻燃等级, 符合UL94 Insulating Material / Flame Retardant Grade, Conforming To UL94		
剥线长度Strip length [mm]		
10		

技术参数Technical Parameter		
厚度Thickness	宽度Width	高度Height
5.2	72.2	36.8
IEC	UL	
800	600	
24	20	
刚性Solid	柔性Fine Stranded	带冷压头Furrule
0.2-4	0.2-2.5	0.2-2.5
24-12	24-12	24-12
其余参数Other Parameters		
绝缘材料/阻燃等级, 符合UL94 Insulating Material / Flame Retardant Grade, Conforming To UL94		
剥线长度Strip length [mm]		
10		

技术参数Technical Parameter		
厚度Thickness	宽度Width	高度Height
6.2	87.4	36.8
IEC	UL	
800	600	
32	30	
刚性Solid	柔性Fine Stranded	带冷压头Furrule
0.2-6	0.2-4	0.2-4
24-10	24-10	24-10
其余参数Other Parameters		
绝缘材料/阻燃等级, 符合UL94 Insulating Material / Flame Retardant Grade, Conforming To UL94		
剥线长度Strip length [mm]		
10		

订货信息Order Information	
订货号Order NO.	TC1.5-4-GY
	TC1.5-4-OG
	TC1.5-4-BU

订货信息Order Information	
订货号Order NO.	TC2.5-4-GY
	TC2.5-4-OG
	TC2.5-4-BU

订货信息Order Information	
订货号Order NO.	TC4-4-GY
	TC4-4-OG
	TC4-4-BU

配套附件Accessory	
订货号Order NO.	TC1.5-4-GY-EA
	TC1.5-4-OG-EA
	TC1.5-4-BU-EA

配套附件Accessory	
订货号Order NO.	TC1.5-4-GY-EA
	TC1.5-4-OG-EA
	TC1.5-4-BU-EA

配套附件Accessory	
订货号Order NO.	TC4-4-GY-EA
	TC4-4-OG-EA
	TC4-4-BU-EA

配套附件Accessory	
订货号Order NO.	TC1.5-4-GY-EB

配套附件Accessory	
订货号Order NO.	TC1.5-4-GY-EB

配套附件Accessory	
订货号Order NO.	TC4-4-GY-EB

跨接件Jumper	
Imax/17.5A	

跨接件Jumper	
Imax/24A	

跨接件Jumper	
Imax/32A	

安全警告标记 Protective Warning Marker	
订货号Order NO.	TMD4.2-5
5位PCS	
正面标记Front Marker	
10位PCS	*
正面标记和侧面标记Front And Side Marker	
可提供印字服务Printing Service	TMB4.2-100

安全警告标记 Protective Warning Marker	
订货号Order NO.	TMD5.2-5
5位PCS	
正面标记Front Marker	
10位PCS	305801
正面标记和侧面标记Front And Side Marker	
可提供印字服务Printing Service	TMB5.2-120

安全警告标记 Protective Warning Marker	
订货号Order NO.	TMD6.2-5
5位PCS	
正面标记Front Marker	
10位PCS	306801
正面标记和侧面标记Front And Side Marker	
可提供印字服务Printing Service	TMB6.2-100

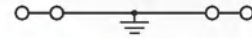
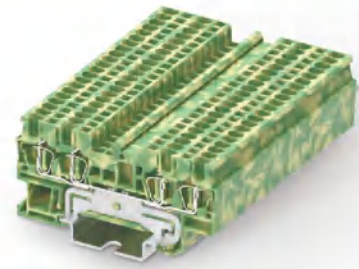

1.5mm² 两进两出接地端子
2-2 Feed Through Ground Terminal Block

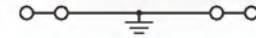
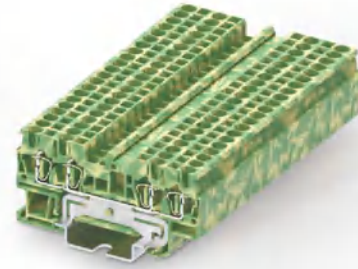

2.5mm² 两进两出接地端子
2-2 Feed Through Ground Terminal Block

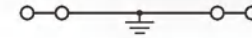
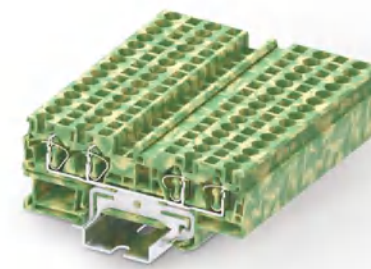

4mm² 两进两出接地端子
2-2 Feed Through Ground Terminal Block

尺寸Size	
注: 安装NS35/7.5导轨后的高度 Note: Height With DIN Rail NS 35/7.5	[mm]
额定参数Rated Parameters	
额定电压Rated Voltage	[V]
额定电流Rated Current	[A]
接线容量Wire Range	
	[mm ²]
	[AWG]
其余参数Other Parameters	
绝缘材料/阻燃等级, 符合UL94 Insulating Material / Flame Retardant Grade, Conforming To UL94	
剥线长度Strip length	[mm]
产品Product	
颜色Colour	黄绿Yellow green
适配NS 35/7.5 NS 35/15导轨 Can Be Used For DIN Rail NS 35/7.5 NS35/15	*
	*
盖板Cover Plate	
厚度2.2mm Thickness2.2mm	灰Gray 橙Orange 蓝Blue
补偿盖板Compensatory Plate	
厚度1.00mm Thickness1.00mm	灰Gray
跨接件Jumper	
位数Poles No.	颜色Colour
2	黄Yellow
3	黄Yellow
4	黄Yellow
...
9	黄Yellow
10	黄Yellow
安全警告标记 Protective Warning Marker	
5位PCS	
正面标记Front Marker	
10位PCS	
正面标记和侧面标记Front And Side Marker	
可提供印字服务Printing Service	

技术参数Technical Parameter		
厚度Thickness	宽度Width	高度Height
4.2	72.2	36.8
IEC	UL	
500	300	
*	*	
刚性Solid	柔性Fine Stranded	带冷压头Furrule
0.2-1.5	0.2-1.5	0.2-1.5
24-16	24-16	24-16
V0		
10		

订货信息Order Information	
订货号Order NO.	TC1.5-4-PE
*	*
*	*

配套附件Accessory	
订货号Order NO.	TC1.5-4-GY-EA
	TC1.5-4-OG-EA
	TC1.5-4-BU-EA
订货号Order NO.	TC1.5-4-GY-EB

订货号Order NO.	*
	*
	*

	*
	*

订货号Order NO.	TMD4.2-5
订货号Order NO.	*
订货号Order NO.	TMB4.2-100

技术参数Technical Parameter		
厚度Thickness	宽度Width	高度Height
5.2	72.2	36.8
IEC	UL	
800	600	
*	*	
刚性Solid	柔性Fine Stranded	带冷压头Furrule
0.2-4	0.2-2.5	0.2-2.5
24-12	24-12	24-12
V0		
10		

订货信息Order Information	
订货号Order NO.	TC2.5-4-PE
*	*
*	*

配套附件Accessory	
订货号Order NO.	TC1.5-4-GY-EA
	TC1.5-4-OG-EA
	TC1.5-4-BU-EA
订货号Order NO.	TC1.5-4-GY-EB

订货号Order NO.	*
	*
	*

	*
	*

订货号Order NO.	TMD5.2-5
订货号Order NO.	305801
订货号Order NO.	TMB5.2-120

技术参数Technical Parameter		
厚度Thickness	宽度Width	高度Height
6.2	87.4	36.8
IEC	UL	
800	600	
*	*	
刚性Solid	柔性Fine Stranded	带冷压头Furrule
0.2-6	0.2-4	0.2-4
24-10	24-10	24-10
V0		
10		

订货信息Order Information	
订货号Order NO.	TC4-4-PE
*	*
*	*

配套附件Accessory	
订货号Order NO.	TC4-4-GY-EA
	TC4-4-OG-EA
	TC4-4-BU-EA
订货号Order NO.	TC4-4-GY-EB

订货号Order NO.	*
	*
	*

	*
	*

订货号Order NO.	TMD6.2-5
订货号Order NO.	306801
订货号Order NO.	TMB6.2-100

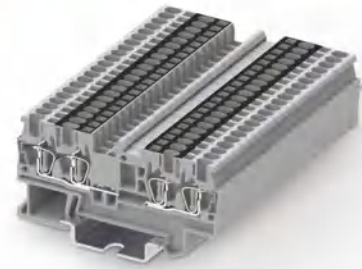

1.5mm² 两进两出分断式接线端子
2-2 Feed Through Terminal Block
With Interrupted Power Rail

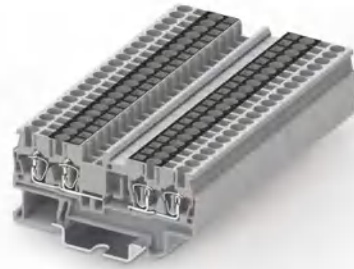

2.5mm² 两进两出分断式接线端子
2-2 Feed Through Terminal Block
With Interrupted Power Rail



4mm² 两进两出分断式接线端子
2-2 Feed Through Terminal Block
With Interrupted Power Rail

尺寸Size	
注: 安装NS35/7.5导轨后的高度 Note: Height With DIN Rail NS 35/7.5	[mm]
额定参数Rated Parameters	
额定电压Rated Voltage	[V]
额定电流Rated Current	[A]
接线容量Wire Range	
	[mm ²]
	[AWG]
其余参数Other Parameters	
绝缘材料/阻燃等级, 符合UL94 Insulating Material / Flame Retardant Grade, Conforming To UL94	
剥线长度Strip length	[mm]
产品Product	
颜色Colour	灰Gray 橙Orange 蓝Blue
适配NS 35/7.5 NS 35/15导轨 Can Be Used For DIN Rail NS 35/7.5 NS35/15	
端板Cover Plate	
厚度2.2mm Thickness2.2mm	灰Gray 橙Orange 蓝Blue
补偿端板Compensatory Plate	
厚度1.00mm Thickness1.00mm	灰Gray
跨接件Jumper	
位数Poles No.	
	颜色Colour
2	黄Yellow
3	黄Yellow
4	黄Yellow
...	...
9	黄Yellow
10	黄Yellow
安全警告标记 Protective Warning Marker	
5位PCS	
正面标记Front Marker	
10位PCS	
正面标记和侧面标记Front And Side Marker	
可提供印字服务Printing Service	

技术参数Technical Parameter		
厚度Thickness	宽度Width	高度Height
4.2	72.2	36.8
IEC	UL	
500	300	
17.5	15	
刚性Solid	柔性Fine Stranded	带冷压头Furrule
0.2-1.5	0.2-1.5	0.2-1.5
24-16	24-16	24-16
其余参数Other Parameters		
绝缘材料/阻燃等级, 符合UL94 Insulating Material / Flame Retardant Grade, Conforming To UL94		
剥线长度Strip length [mm]		
10		

订货信息Order Information	
订货号Order NO.	TC1.5-2X2-GY TC1.5-2X2-OG TC1.5-2X2-BU

配套附件Accessory	
端板Cover Plate	订货号Order NO. TC1.5-4-GY-EA TC1.5-4-OG-EA TC1.5-4-BU-EA
补偿端板Compensatory Plate	订货号Order NO. TC1.5-4-GY-EB

跨接件Jumper	
Imax/17.5A	订货号Order NO. TJA4.2-2 TJA4.2-3 TJA4.2-4 TJA4.2-9 TJA4.2-10

安全警告标记 Protective Warning Marker	订货号Order NO. TMD4.2-5
正面标记Front Marker	订货号Order NO. *
正面标记和侧面标记Front And Side Marker	订货号Order NO. TMB4.2-100

技术参数Technical Parameter		
厚度Thickness	宽度Width	高度Height
5.2	72.2	36.8
IEC	UL	
800	600	
24	20	
刚性Solid	柔性Fine Stranded	带冷压头Furrule
0.2-4	0.2-2.5	0.2-2.5
24-12	24-12	24-12
其余参数Other Parameters		
绝缘材料/阻燃等级, 符合UL94 Insulating Material / Flame Retardant Grade, Conforming To UL94		
剥线长度Strip length [mm]		
10		

订货信息Order Information	
订货号Order NO.	TC2.5-2X2-GY TC2.5-2X2-OG TC2.5-2X2-BU

配套附件Accessory	
端板Cover Plate	订货号Order NO. TC1.5-4-GY-EA TC1.5-4-OG-EA TC1.5-4-BU-EA

跨接件Jumper	
Imax/24A	订货号Order NO. TJA5.2-2 TJA5.2-3 TJA5.2-4 TJA5.2-9 TJA5.2-10

安全警告标记 Protective Warning Marker	订货号Order NO. TMD5.2-5
正面标记Front Marker	订货号Order NO. 305801
正面标记和侧面标记Front And Side Marker	订货号Order NO. TMB5.2-120

技术参数Technical Parameter		
厚度Thickness	宽度Width	高度Height
6.2	87.4	36.8
IEC	UL	
800	600	
32	30	
刚性Solid	柔性Fine Stranded	带冷压头Furrule
0.2-6	0.2-4	0.2-4
24-10	24-10	24-10
其余参数Other Parameters		
绝缘材料/阻燃等级, 符合UL94 Insulating Material / Flame Retardant Grade, Conforming To UL94		
剥线长度Strip length [mm]		
10		

订货信息Order Information	
订货号Order NO.	TC4-2X2-GY TC4-2X2-OG TC4-2X2-BU

配套附件Accessory	
端板Cover Plate	订货号Order NO. TC4-4-GY-EA TC4-4-OG-EA TC4-4-BU-EA

跨接件Jumper	
Imax/32A	订货号Order NO. TJA6.2-2 TJA6.2-3 TJA6.2-4 TJA6.2-9 TJA6.2-10

安全警告标记 Protective Warning Marker	订货号Order NO. TMD6.2-5
正面标记Front Marker	订货号Order NO. 306801
正面标记和侧面标记Front And Side Marker	订货号Order NO. TMB6.2-100

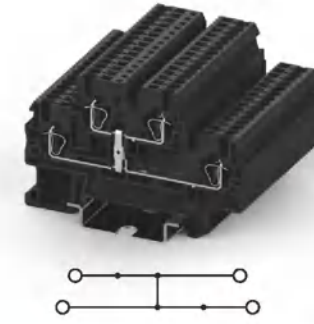
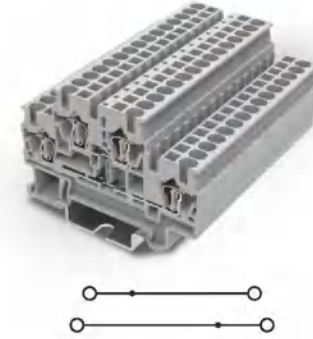
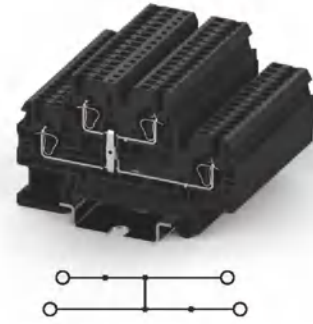
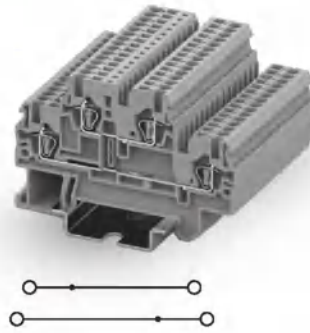

1.5mm² 双层接线端子
Double Level Terminal Block

1.5mm² 双层等电位接线端子
Double Level With Equipotential Bonder Terminal Block

2.5mm² 双层接线端子
Double Level Terminal Block

2.5mm² 双层等电位接线端子
Double Level With Equipotential Bonder Terminal Block

尺寸Size	
注: 安装NS35/7.5导轨后的高度 Note: Height With DIN Rail NS 35/7.5	[mm]
额定电压Rated Voltage	[V]
额定电流Rated Current	[A]
接线容量Wire Range	
	[mm ²]
	[AWG]
其余参数Other Parameters	
绝缘材料/阻燃等级, 符合UL94 Insulating Material / Flame Retardant Grade, Conforming To UL94	
剥线长度Strip length	[mm]

技术参数Technical Parameter		
厚度Thickness	宽度Width	高度Height
3.5	68	43.4
IEC	UL	
500	300	
16	15	
接线容量Wire Range		
刚性Solid	柔性Fine Stranded	带冷压头Furrule
0.2-1.5	0.2-1.5	0.2-1
26-14	26-14	18-14
其余参数Other Parameters		
绝缘材料/阻燃等级, 符合UL94 Insulating Material / Flame Retardant Grade, Conforming To UL94	V0	
剥线长度Strip length	10	

技术参数Technical Parameter		
厚度Thickness	宽度Width	高度Height
3.5	68	43.4
IEC	UL	
500	300	
16	15	
接线容量Wire Range		
刚性Solid	柔性Fine Stranded	带冷压头Furrule
0.2-1.5	0.2-1.5	0.2-1
26-14	26-14	18-14
其余参数Other Parameters		
绝缘材料/阻燃等级, 符合UL94 Insulating Material / Flame Retardant Grade, Conforming To UL94	V0	
剥线长度Strip length	10	

技术参数Technical Parameter		
厚度Thickness	宽度Width	高度Height
5.2	68	47.5
IEC	UL	
500	600	
22	20	
接线容量Wire Range		
刚性Solid	柔性Fine Stranded	带冷压头Furrule
0.2-4	0.2-2.5	0.2-2.5
24-12	24-12	24-12
其余参数Other Parameters		
绝缘材料/阻燃等级, 符合UL94 Insulating Material / Flame Retardant Grade, Conforming To UL94	V0	
剥线长度Strip length	10	

技术参数Technical Parameter		
厚度Thickness	宽度Width	高度Height
5.2	68	47.5
IEC	UL	
500	600	
22	20	
接线容量Wire Range		
刚性Solid	柔性Fine Stranded	带冷压头Furrule
0.2-4	0.2-2.5	0.2-2.5
24-12	24-12	24-12
其余参数Other Parameters		
绝缘材料/阻燃等级, 符合UL94 Insulating Material / Flame Retardant Grade, Conforming To UL94	V0	
剥线长度Strip length	10	

产品Product		颜色Colour
适配NS 35/7.5 NS 35/15导轨 Can Be Used For DIN Rail NS 35/7.5 NS35/15		灰Gray
		橙Orange
		蓝Blue

订货信息Order Information	
订货号Order NO.	
TCD1.5-2-GY	
TCD1.5-2-OG	*
TCD1.5-2-BU	*

订货信息Order Information	
订货号Order NO.	
TCD1.5-2-PV(黑色)	
*	
*	

端板Cover Plate	
厚度2.2mm Thickness2.2mm	灰Gray
	橙Orange
	蓝Blue

配套附件Accessory	
订货号Order NO.	
TCD1.5-2-GY-EA	
TCD1.5-2-OG-EA	
TCD1.5-2-BU-EA	

配套附件Accessory	
订货号Order NO.	
TCD1.5-2-GY-EA	
TCD1.5-2-OG-EA	
TCD1.5-2-BU-EA	

补偿端板Compensatory Plate	
厚度1.00mm Thickness1.00mm	灰Gray

配套附件Accessory	
订货号Order NO.	
*	

配套附件Accessory	
订货号Order NO.	
*	

跨接件Jumper	
位数Poles No.	颜色Colour
2	黄Yellow
3	黄Yellow
4	黄Yellow
...
9	黄Yellow
10	黄Yellow

跨接件Jumper	
Imax/24A	
订货号Order NO.	
2150-302	
2150-303	
2150-304	
.....	
2150-309	
2150-310	

跨接件Jumper	
Imax/24A	
订货号Order NO.	
2150-302	
2150-303	
2150-304	
.....	
2150-309	
2150-310	

安全警告标记 Protective Warning Marker	
5位PCS	*
正面标记Front Marker	订货号Order NO.
10位PCS	*
正面标记和侧面标记Front And Side Marker	订货号Order NO.
可提供印字服务Printing Service	TMB3.5-100

安全警告标记 Protective Warning Marker	
5位PCS	*
正面标记Front Marker	订货号Order NO.
10位PCS	*
正面标记和侧面标记Front And Side Marker	订货号Order NO.
可提供印字服务Printing Service	TMB3.5-100

安全警告标记 Protective Warning Marker	
5位PCS	*
正面标记Front Marker	订货号Order NO.
10位PCS	*
正面标记和侧面标记Front And Side Marker	订货号Order NO.
可提供印字服务Printing Service	TMB3.5-100

订货信息Order Information	
订货号Order NO.	
TCD2.5-2-GY	
TCD2.5-2-OG	*
TCD2.5-2-BU	*

订货信息Order Information	
订货号Order NO.	
TCD2.5-2-PV(黑色)	
*	
*	

配套附件Accessory	
订货号Order NO.	
TCD2.5-2-GY-EA	
TCD2.5-2-OG-EA	
TCD2.5-2-BU-EA	

配套附件Accessory	
订货号Order NO.	
TCD2.5-2-GY-EA	
TCD2.5-2-OG-EA	
TCD2.5-2-BU-EA	

跨接件Jumper	
Imax/20A	
订货号Order NO.	
TJA5.2-2	
TJA5.2-3	
TJA5.2-4	
.....	
TJA5.2-9	
TJA5.2-10	

跨接件Jumper	
Imax/20A	
订货号Order NO.	
TJA5.2-2	
TJA5.2-3	
TJA5.2-4	
.....	
TJA5.2-9	
TJA5.2-10	

安全警告标记 Protective Warning Marker	
5位PCS	*
正面标记Front Marker	订货号Order NO.
10位PCS	*
正面标记和侧面标记Front And Side Marker	订货号Order NO.
可提供印字服务Printing Service	TMB5.2-120

安全警告标记 Protective Warning Marker	
5位PCS	*
正面标记Front Marker	订货号Order NO.
10位PCS	*
正面标记和侧面标记Front And Side Marker	订货号Order NO.
可提供印字服务Printing Service	TMB5.2-120

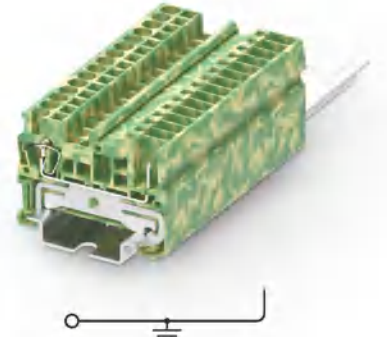
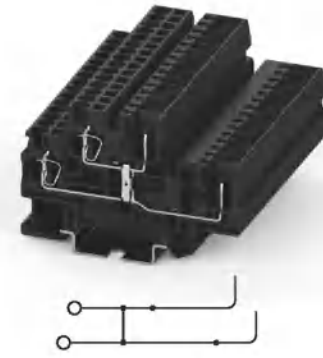
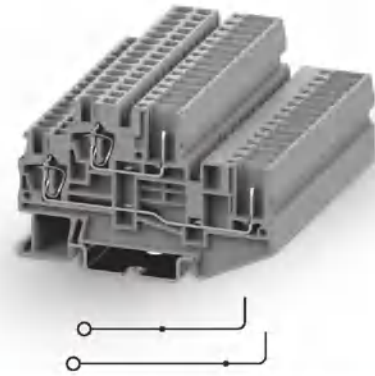
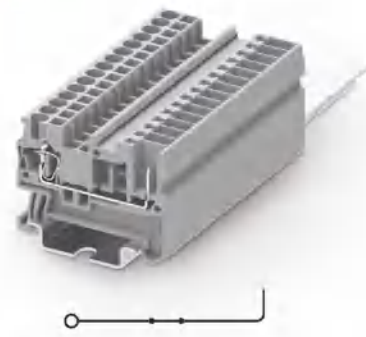

2.5mm² 一进一出插拔接线端子
1-1 Feed Through Plug-in Terminal Block

2.5mm² 双层插拔接线端子
Double-level Pluggable Terminal Block

2.5mm² 双层等电位插拔接线端子
Double Level With Equipotential Bonder Plug-in Terminal Block

2.5mm² 一进一出插拔接地端子
1-1 Feed Through Ground Plug-in Terminal Block

尺寸Size	
注: 安装NS35/7.5导轨后的高度 Note: Height With DIN Rail NS 35/7.5	[mm]
额定参数Rated Parameters	
额定电压Rated Voltage	[V]
额定电流Rated Current	[A]
接线容量Wire Range	
	[mm ²]
	[AWG]
其余参数Other Parameters	
绝缘材料/阻燃等级, 符合UL94 Insulating Material / Flame Retardant Grade, Conforming To UL94	
剥线长度Strip length	[mm]

技术参数Technical Parameter		
厚度Thickness	宽度Width	高度Height
5.2	68	47.5
IEC	UL	
500	300	
24	20	
接线容量Wire Range		
刚性Solid	柔性Fine Stranded	带冷压头Furrule
0.2-4	0.2-2.5	0.2-2.5
24-12	24-12	24-12
其余参数Other Parameters		
绝缘材料/阻燃等级, 符合UL94 Insulating Material / Flame Retardant Grade, Conforming To UL94		
剥线长度Strip length [mm]		
10		

技术参数Technical Parameter		
厚度Thickness	宽度Width	高度Height
5.2	71.5	46
IEC	UL	
500	600	
22	20	
接线容量Wire Range		
刚性Solid	柔性Fine Stranded	带冷压头Furrule
0.2-4	0.2-2.5	0.2-2.5
24-12	24-12	24-12
其余参数Other Parameters		
绝缘材料/阻燃等级, 符合UL94 Insulating Material / Flame Retardant Grade, Conforming To UL94		
剥线长度Strip length [mm]		
10		

技术参数Technical Parameter		
厚度Thickness	宽度Width	高度Height
5.2	71.5	46
IEC	UL	
500	600	
22	20	
接线容量Wire Range		
刚性Solid	柔性Fine Stranded	带冷压头Furrule
0.2-4	0.2-2.5	0.2-2.5
24-12	24-12	24-12
其余参数Other Parameters		
绝缘材料/阻燃等级, 符合UL94 Insulating Material / Flame Retardant Grade, Conforming To UL94		
剥线长度Strip length [mm]		
10		

尺寸Size	
注: 安装NS35/7.5导轨后的高度 Note: Height With DIN Rail NS 35/7.5	[mm]
额定参数Rated Parameters	
额定电压Rated Voltage	[V]
额定电流Rated Current	[A]
接线容量Wire Range	
	[mm ²]
	[AWG]
其余参数Other Parameters	
绝缘材料/阻燃等级, 符合UL94 Insulating Material / Flame Retardant Grade, Conforming To UL94	
剥线长度Strip length	[mm]

技术参数Technical Parameter		
厚度Thickness	宽度Width	高度Height
5.2	68	47.5
IEC	UL	
500	300	
*	*	
接线容量Wire Range		
刚性Solid	柔性Fine Stranded	带冷压头Furrule
0.2-4	0.2-2.5	0.2-2.5
24-12	24-12	24-12
其余参数Other Parameters		
绝缘材料/阻燃等级, 符合UL94 Insulating Material / Flame Retardant Grade, Conforming To UL94		
剥线长度Strip length [mm]		
10		

产品Product		颜色Colour
适配NS 35/7.5 NS 35/15导轨 Can Be Used For DIN Rail NS 35/7.5 NS35/15		灰Gray
		橙Orange
		蓝Blue

订货信息Order Information	
订货号Order NO.	产品Code
TC2.5-2-1-GY	TC2.5-2-1-GY
TC2.5-2-1-OG	TC2.5-2-1-OG
TC2.5-2-1-BU	TC2.5-2-1-BU

订货信息Order Information	
订货号Order NO.	产品Code
TCD2.5-2-1-GY	TCD2.5-2-1-GY
TCD2.5-2-1-OG	TCD2.5-2-1-OG
TCD2.5-2-1-BU	TCD2.5-2-1-BU

订货信息Order Information	
订货号Order NO.	产品Code
TCD2.5-2-1-PV(黑色)	TCD2.5-2-1-PV(黑色)
*	*
*	*

产品Product		颜色Colour
适配NS 35/7.5 NS 35/15导轨 Can Be Used For DIN Rail NS 35/7.5 NS35/15		黄绿Yellow green
		*
		*

订货信息Order Information	
订货号Order NO.	产品Code
TC2.5-2-1-PE	TC2.5-2-1-PE
*	*
*	*

端板Cover Plate	
厚度2.2mm Thickness2.2mm	灰Gray
	橙Orange
	蓝Blue

配套附件Accessory	
订货号Order NO.	产品Code
TC1.5-2-GY-EA	TCD2.5-2-1-GY-EA
TC1.5-2-OG-EA	TCD2.5-2-1-OG-EA
TC1.5-2-BU-EA	TCD2.5-2-1-BU-EA

配套附件Accessory	
订货号Order NO.	产品Code
TCD2.5-2-1-GY-EA	TCD2.5-2-1-GY-EA
TCD2.5-2-1-OG-EA	TCD2.5-2-1-OG-EA
TCD2.5-2-1-BU-EA	TCD2.5-2-1-BU-EA

配套附件Accessory	
订货号Order NO.	产品Code
TCD2.5-2-1-GY-EA	TCD2.5-2-1-GY-EA
TCD2.5-2-1-OG-EA	TCD2.5-2-1-OG-EA
TCD2.5-2-1-BU-EA	TCD2.5-2-1-BU-EA

端板Cover Plate	
厚度2.2mm Thickness2.2mm	灰Gray
	橙Orange
	蓝Blue

配套附件Accessory	
订货号Order NO.	产品Code
TC1.5-2-GY-EA	TCD2.5-2-1-GY-EA
TC1.5-2-OG-EA	TCD2.5-2-1-OG-EA
TC1.5-2-BU-EA	TCD2.5-2-1-BU-EA

补偿端板Compensatory Plate	
厚度1.00mm Thickness1.00mm	灰Gray

配套附件Accessory	
订货号Order NO.	产品Code
*	*

配套附件Accessory	
订货号Order NO.	产品Code
*	*

配套附件Accessory	
订货号Order NO.	产品Code
*	*

补偿端板Compensatory Plate	
厚度1.00mm Thickness1.00mm	灰Gray

配套附件Accessory	
订货号Order NO.	产品Code
*	*

跨接件Jumper	
位数Poles No.	颜色Colour
2	黄Yellow
3	黄Yellow
4	黄Yellow
...
9	黄Yellow
10	黄Yellow

跨接件Jumper	
位数Poles No.	颜色Colour
2	黄Yellow
3	黄Yellow
4	黄Yellow
...
9	黄Yellow
10	黄Yellow

跨接件Jumper	
位数Poles No.	颜色Colour
2	黄Yellow
3	黄Yellow
4	黄Yellow
...
9	黄Yellow
10	黄Yellow

跨接件Jumper	
位数Poles No.	颜色Colour
2	黄Yellow
3	黄Yellow
4	黄Yellow
...
9	黄Yellow
10	黄Yellow

跨接件Jumper	
位数Poles No.	颜色Colour
2	黄Yellow
3	黄Yellow
4	黄Yellow
...
9	黄Yellow
10	黄Yellow

跨接件Jumper	
位数Poles No.	颜色Colour
2	黄Yellow
3	黄Yellow
4	黄Yellow
...
9	黄Yellow
10	黄Yellow

安全警告标记 Protective Warning Marker	
5位PCS	5位PCS
正面标记Front Marker	正面标记Front Marker
10位PCS	10位PCS
正面标记和侧面标记Front And Side Marker	正面标记和侧面标记Front And Side Marker
可提供印字服务Printing Service	可提供印字服务Printing Service

安全警告标记 Protective Warning Marker	
订货号Order NO.	产品Code
TMD5.2-5	TMD5.2-5
正面标记Front Marker	正面标记Front Marker
10位PCS	305801
正面标记和侧面标记Front And Side Marker	正面标记和侧面标记Front And Side Marker
可提供印字服务Printing Service	可提供印字服务Printing Service
TMB5.2-120	TMB5.2-120

安全警告标记 Protective Warning Marker	
订货号Order NO.	产品Code
TMD5.2-5	TMD5.2-5
正面标记Front Marker	正面标记Front Marker
10位PCS	*
正面标记和侧面标记Front And Side Marker	正面标记和侧面标记Front And Side Marker
可提供印字服务Printing Service	可提供印字服务Printing Service
TMB5.2-120	TMB5.2-120

安全警告标记 Protective Warning Marker	
订货号Order NO.	产品Code
TMD5.2-5	TMD5.2-5
正面标记Front Marker	正面标记Front Marker
10位PCS	*
正面标记和侧面标记Front And Side Marker	正面标记和侧面标记Front And Side Marker
可提供印字服务Printing Service	可提供印字服务Printing Service
TMB5.2-120	TMB5.2-120

安全警告标记 Protective Warning Marker	
订货号Order NO.	产品Code
TMD5.2-5	TMD5.2-5
正面标记Front Marker	正面标记Front Marker
10位PCS	305801
正面标记和侧面标记Front And Side Marker	正面标记和侧面标记Front And Side Marker
可提供印字服务Printing Service	可提供印字服务Printing Service
TMB5.2-120	TMB5.2-120

安全警告标记 Protective Warning Marker	
订货号Order NO.	产品Code
TMD5.2-5	TMD5.2-5
正面标记Front Marker	正面标记Front Marker
10位PCS	305801
正面标记和侧面标记Front And Side Marker	正面标记和侧面标记Front And Side Marker
可提供印字服务Printing Service	可提供印字服务Printing Service
TMB5.2-120	TMB5.2-120

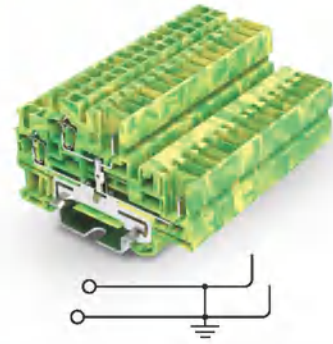

2.5mm² 双层插拔接地端子
Double-level Pluggable Ground Terminal Block

尺寸Size	
注: 安装NS35/7.5导轨后的高度 Note: Height With DIN Rail NS 35/7.5	[mm]
额定参数Rated Parameters	
额定电压Rated Voltage	[V]
额定电流Rated Current	[A]
接线容量Wire Range	
	[mm ²]
	[AWG]
其余参数Other Parameters	
绝缘材料/阻燃等级, 符合UL94 Insulating Material / Flame Retardant Grade, Conforming To UL94	
剥线长度Strip length	[mm]

技术参数Technical Parameter		
厚度Thickness	宽度Width	高度Height
5.2	71.5	46
IEC	UL	
500	600	
*	*	
接线容量Wire Range		
刚性Solid	柔性Fine Stranded	带冷压头Furrule
0.2-4	0.2-2.5	0.2-2.5
24-12	24-12	24-12
其余参数Other Parameters		
绝缘材料/阻燃等级, 符合UL94 Insulating Material / Flame Retardant Grade, Conforming To UL94		
剥线长度Strip length [mm]		
10		

产品Product	
颜色Colour	黄绿Yellow green
适配NS 35/7.5 NS 35/15导轨 Can Be Used For DIN Rail NS 35/7.5 NS35/15	*

订货信息Order Information	
订货号Order NO.	TCD2.5-2-1-PE

端板Cover Plate	
厚度2.2mm Thickness2.2mm	灰Gray
	橙Orange
	蓝Blue

配套附件Accessory	
订货号Order NO.	TCD2.5-2-1-GY-EA
	TCD2.5-2-1-OG-EA
	TCD2.5-2-1-BU-EA

补偿端板Compensatory Plate	
厚度1.00mm Thickness1.00mm	灰Gray

订货号Order NO.	
*	

跨接件Jumper	
位数Poles No.	颜色Colour
2	黄Yellow
3	黄Yellow
4	黄Yellow
...
9	黄Yellow
10	黄Yellow

Imax/24A	
订货号Order NO.	*

安全警告标记 Protective Warning Marker	
5位PCS	TMD5.2-5
正面标记Front Marker	
10位PCS	*
正面标记和侧面标记Front And Side Marker	
可提供印字服务Printing Service	TMB5.2-120

安全警告标记 Protective Warning Marker	
5位PCS	TMD5.2-5
正面标记Front Marker	
10位PCS	*
正面标记和侧面标记Front And Side Marker	
可提供印字服务Printing Service	TMB5.2-120

079

备注: (所有连接导线的总电流不得超过产品的额定电流)

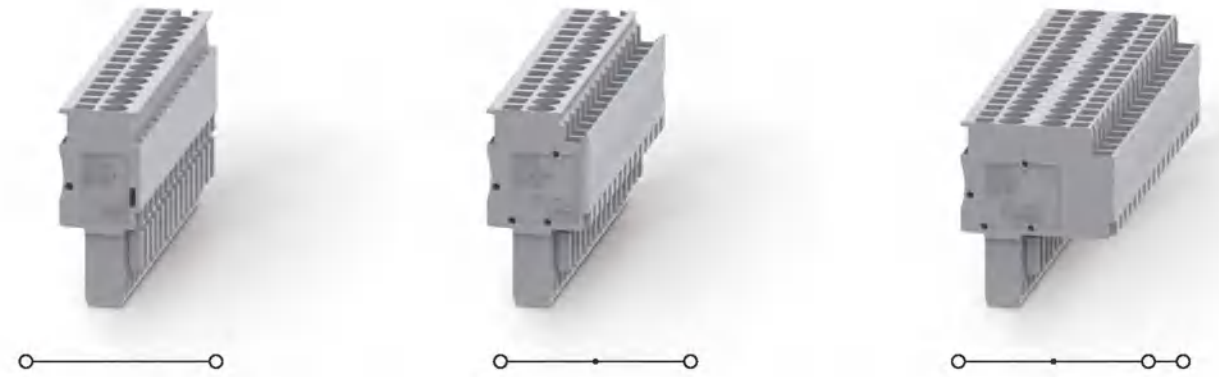

2.5mm² 插头
Plug

技术参数Technical Parameter		
厚度Thickness	宽度Width	高度Height
5.2	16.1	39.4
IEC	UL	
500	300	
24	20	
接线容量Wire Range		
刚性Solid	柔性Fine Stranded	带冷压头Furrule
0.2-4	0.2-2.5	0.2-2.5
24-12	24-12	24-12
其余参数Other Parameters		
绝缘材料/阻燃等级, 符合UL94 Insulating Material / Flame Retardant Grade, Conforming To UL94		
剥线长度Strip length [mm]		
10		

订货信息Order Information

订货号Order NO.	TCP2.5-1-GY
	TCP2.5-2-GY
.....
	TCP2.5-14-GY
	TCP2.5-15-GY
	TCP2.5-1-BU
	TCP2.5-1-OG
	TCP2.5-1-PE
Imax/24A	
订货号Order NO.	*
	TJA5.2-2
	TJA5.2-3
	TJA5.2-4
.....
	TJA5.2-9
	TJA5.2-10
订货号Order NO.	*
订货号Order NO.	*
订货号Order NO.	*
订货号Order NO.	TMB5.2-120

2.5mm² 可跨接插头
Transable Plug

技术参数Technical Parameter		
厚度Thickness	宽度Width	高度Height
5.2	20.1	39.4
IEC	UL	
500	300	
24	20	
接线容量Wire Range		
刚性Solid	柔性Fine Stranded	带冷压头Furrule
0.2-4	0.2-2.5	0.2-2.5
24-12	24-12	24-12
其余参数Other Parameters		
绝缘材料/阻燃等级, 符合UL94 Insulating Material / Flame Retardant Grade, Conforming To UL94		
剥线长度Strip length [mm]		
10		

订货信息Order Information

订货号Order NO.	TCPB2.5-1-GY
	TCPB2.5-2-GY
.....
	TCPB2.5-14-GY
	TCPB2.5-15-GY
	TCPB2.5-1-BU
	TCPB2.5-1-OG
	TCPB2.5-1-PE
Imax/24A	
订货号Order NO.	*
	TJA5.2-2
	TJA5.2-3
	TJA5.2-4
.....
	TJA5.2-9
	TJA5.2-10
订货号Order NO.	*
订货号Order NO.	*
订货号Order NO.	*
订货号Order NO.	TMB5.2-120

2.5mm² 2位可跨接插头
Double-row Transable Plug

技术参数Technical Parameter		
厚度Thickness	宽度Width	高度Height
5.2	32.6	39.4
IEC	UL	
500	300	
24	20	
接线容量Wire Range		
刚性Solid	柔性Fine Stranded	带冷压头Furrule
0.2-4	0.2-2.5	0.2-2.5
24-12	24-12	24-12
其余参数Other Parameters		
绝缘材料/阻燃等级, 符合UL94 Insulating Material / Flame Retardant Grade, Conforming To UL94		
剥线长度Strip length [mm]		
10		

订货信息Order Information

订货号Order NO.	TCPDB2.5-1-GY
	TCPDB2.5-2-GY
.....
	TCPDB2.5-14-GY
	TCPDB2.5-15-GY
	TCPDB2.5-1-BU
	TCPDB2.5-1-OG
	TCPDB2.5-1-PE
Imax/24A	
订货号Order NO.	*
	TJA5.2-2
	TJA5.2-3
	TJA5.2-4
.....
	TJA5.2-9
	TJA5.2-10
订货号Order NO.	*
订货号Order NO.	*
订货号Order NO.	*
订货号Order NO.	TMB5.2-120

Mark: (Total current which connects to all the wires, cannot be over rated current).

TU系列螺钉接线端子

TU Rail-mounted terminal blocks with screw clamp

TU系列螺钉接线端子采用螺钉接线技术，适用于各种应用领域。该系列产品可实现多导线连接，使连接方式更加灵活。其防脱圈设计可有效防止螺钉松脱，保证端子的连接性能。产品设计制造符合IEC/EN60947、UL1059等国际标准。

TU series screw terminals use screw wiring technology and are suitable for a variety of applications. This series of products can realize multiwire connection, making the connection mode more flexible. Its detachable coil design can effectively prevent screw loose and ensure the connection performance of terminals. The products are designed and manufactured in accordance with IEC/EN60947, UL1059 and other international standards.

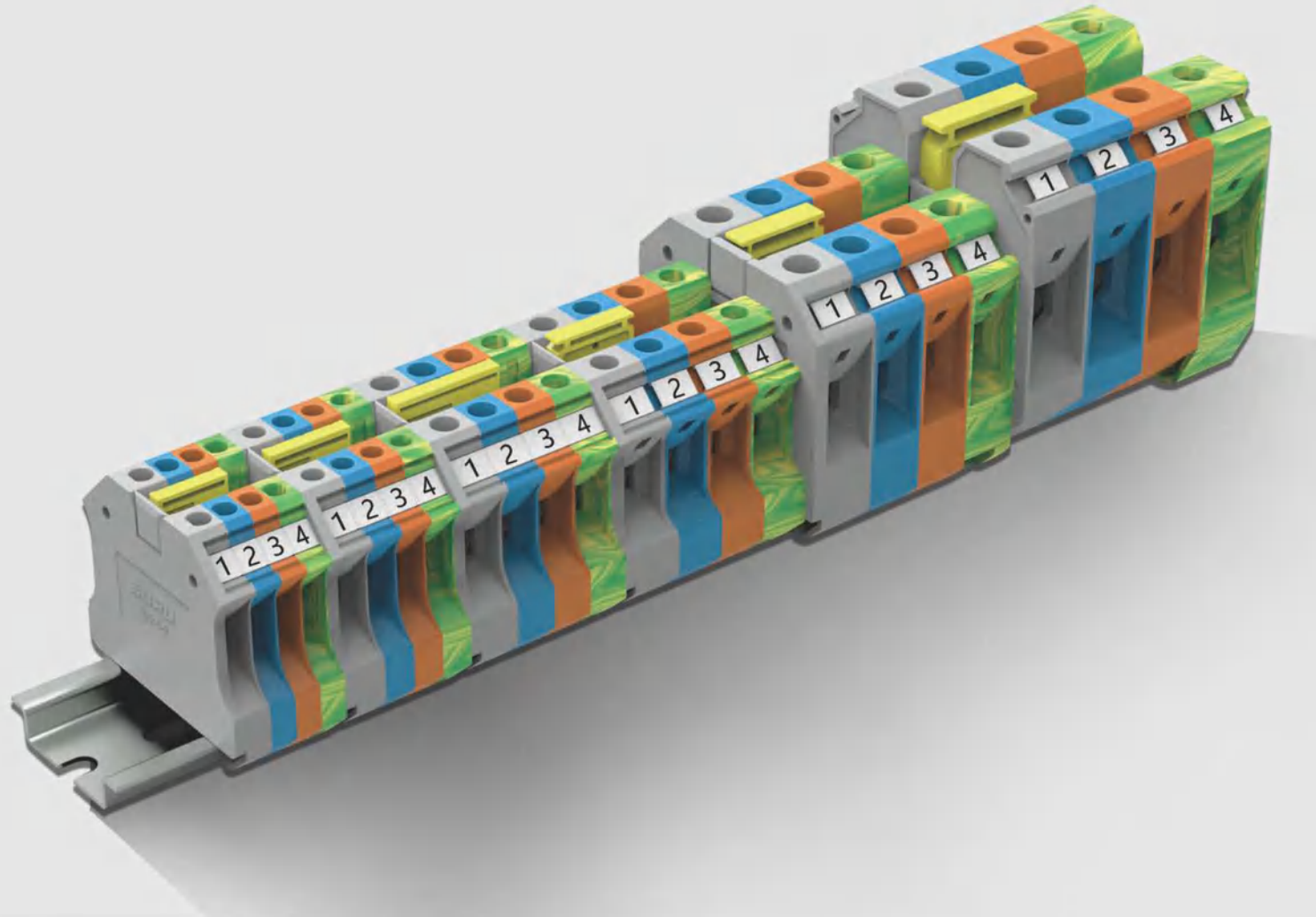

卡接式接地端子 Clamping ground terminal

▲ 与接线端子外形相同，无需工具，可快速的直接卡入DIN导轨。符合IEC60947-7-2标准，满足所有机械及电气性能。

▲ The same shape as the normal terminal block, can be quickly and directly stuck into DIN guide without any tools. Meet the IEC60947-7-2 standard, meet all mechanical and electrical performance.



标识 Marking

▲ 提供三种标记方案，可按需求自由选择。特别增加PVC标记牌，可标记复杂描述。

▲ Three marking schemes are provided, which can be freely selected according to requirements. Especially add PVC label, can mark complex description.

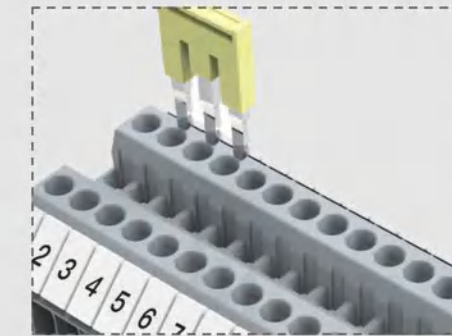

跨接 Jumper

▲ 跨接结构标准化，与其他系列端子共用跨接桥。双排跨接设计，提供更多的电路连接方案。

▲ The bridge structure is standardized, sharing the bridge with other series of the terminals. Double row jumper design, provide more circuit connection scheme.

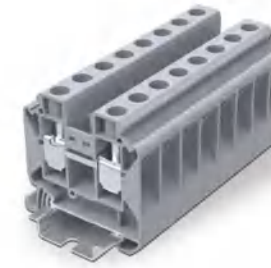

2.5mm² TU接线端子
TU Terminal Block

4mm² TU接线端子
TU Terminal Block

6mm² TU接线端子
TU Terminal Block

10mm² TU接线端子
TU Terminal Block

16mm² TU接线端子
Ground Terminal Block

技术参数Technical Parameter			
尺寸Size	厚度Thickness	宽度Width	高度Height
注: 安装NS35/7.5导轨后的高度 Note: Height With DIN Rail NS 35/7.5	[mm]	5.2	46.2
额定参数Rated Parameters	IEC	UL	
额定电压Rated Voltage	[V]	1000	600
额定电流Rated Current	[A]	24	20
接线容量Wire Range	刚性Solid	柔性Fine Stranded	带冷压头Furrule
	[mm ²]	0.2-4	0.25-2.5
	[AWG]	26-12	26-12
螺钉类型Screw Type	[*]	M2.5	
扭矩Torque	[N.m]	0.4	
其余参数Other Parameters			
绝缘材料/阻燃等级, 符合UL94 Insulating Material / Flame Retardant Grade, Conforming To UL94		V0	
剥线长度Strip length	[mm]	8-9	
订货信息Order Information			
产品Product	颜色Colour	订货号Order NO.	
适配NS 35/7.5导轨 Can Be Used For DIN Rail NS 35/7.5	灰Gray	TU2.5-2-GY	
	橙Orange	TU2.5-2-OG	
	蓝Blue	TU2.5-2-BU	
配套附件Accessory			
盖板Cover Plate	颜色Colour	订货号Order NO.	
盖板Cover Plate	灰Gray	TU2.5-2-GY-EA	
	橙Orange	TU2.5-2-OG-EA	
跨接件Jumper			
极数Poles No.		订货号Order NO.	
2		TJA5.2-2	
3		TJA5.2-3	
4		TJA5.2-4	
5		TJA5.2-5	
6		TJA5.2-6	
7		TJA5.2-7	
8		TJA5.2-8	
9		TJA5.2-9	
10		TJA5.2-10	
正面标记(小)Front Marker(Small)		订货号Order NO.	
可提供印字服务Printing Service		TMB5.2-120	
正面标记(大)Front Marker(Big)		订货号Order NO.	
可提供印字服务Printing Service		305801	

技术参数Technical Parameter		
厚度Thickness	宽度Width	高度Height
6.2	47.3	46.2
IEC	UL	
1000	600	
32	30	
刚性Solid	柔性Fine Stranded	带冷压头Furrule
0.2-6	0.2-4	0.2-4
26-10	26-10	26-10
	M3	
	0.5	
	V0	
	8-9	
订货信息Order Information		
		订货号Order NO.
		TU4-2-GY
		TU4-2-OG
		TU4-2-BU
配套附件Accessory		
		订货号Order NO.
		TU2.5-2-GY-EA
		TU2.5-2-OG-EA
		订货号Order NO.
		TJA6.2-2
		TJA6.2-3
		TJA6.2-4
		TJA6.2-5
		TJA6.2-6
		TJA6.2-7
		TJA6.2-8
		TJA6.2-9
		TJA6.2-10
		订货号Order NO.
		TMB6.2-100
		订货号Order NO.
		306801

技术参数Technical Parameter		
厚度Thickness	宽度Width	高度Height
8.2	47.3	46.2
IEC	UL	
1000	600	
41	50	
刚性Solid	柔性Fine Stranded	带冷压头Furrule
0.2-10	0.2-6	0.25-6
24-8	24-8	24-8
	M4	
	1.2	
	V0	
	9-10	
订货信息Order Information		
		订货号Order NO.
		TU6-2-GY
		TU6-2-OG
		TU6-2-BU
配套附件Accessory		
		订货号Order NO.
		TU2.5-2-GY-EA
		TU2.5-2-OG-EA
		订货号Order NO.
		TJA8.2-2
		TJA8.2-3
		TJA8.2-4
		TJA8.2-5
		TJA8.2-6
		TJA8.2-7
		TJA8.2-8
		TJA8.2-9
		TJA8.2-10
		订货号Order NO.
		TMB8.2-50
		订货号Order NO.
		308801

技术参数Technical Parameter		
厚度Thickness	宽度Width	高度Height
10.2	47.3	46.2
IEC	UL	
1000	600	
57	65	
刚性Solid	柔性Fine Stranded	带冷压头Furrule
0.5-16	0.5-10	0.5-10
20-6	20-6	20-6
	M4	
	1.2	
	V0	
	10-11	
订货信息Order Information		
		订货号Order NO.
		TU10-2-GY
		TU10-2-OG
		TU10-2-BU
配套附件Accessory		
		订货号Order NO.
		TU2.5-2-GY-EA
		TU2.5-2-OG-EA
		订货号Order NO.
		TJA10.2-2
		*
		*
		*
		*
		*
		*
		*
		*
		订货号Order NO.
		TMB10.2-10
		订货号Order NO.
		310801

技术参数Technical Parameter		
厚度Thickness	宽度Width	高度Height
12.2	52.8	54.35
IEC	UL	
1000	600	
76	85	
刚性Solid	柔性Fine Stranded	带冷压头Furrule
1.5-25	1.5-16	1.5-16
16-4	16-4	16-4
	M5	
	2.0	
	V0	
	13-14	
订货信息Order Information		
		订货号Order NO.
		TU16-2-GY
		TU16-2-OG
		TU16-2-BU
配套附件Accessory		
		订货号Order NO.
		TU16-2-GY-EA
		TU16-2-OG-EA
		订货号Order NO.
		TJA12.2-2
		*
		*
		*
		*
		*
		*
		*
		订货号Order NO.
		TMB10.2-10
		订货号Order NO.
		310801

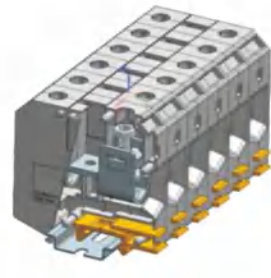

	35mm ² TU接线端子 TU Terminal Block			50mm ² TU接线端子 TU Terminal Block			70mm ² TU接线端子 TU Terminal Block			95mm ² TU接线端子 TU Terminal Block			150mm ² TU接线端子 Ground Terminal Block		
	技术参数Technical Parameter			技术参数Technical Parameter			技术参数Technical Parameter			技术参数Technical Parameter			技术参数Technical Parameter		
尺寸Size	厚度Thickness	宽度Width	高度Height	厚度Thickness	宽度Width	高度Height	厚度Thickness	宽度Width	高度Height	厚度Thickness	宽度Width	高度Height	厚度Thickness	宽度Width	高度Height
注: 安装NS35/7.5导轨后的高度 Note: Height With DIN Rail NS 35/7.5	16	59.2	65.05	20.4	70.7	76.1	20.6	78.6	76	25	83.2	90.1	32	101.4	111
额定电压Rated Voltage [V]	1000	600		1000	600		1000	600		1000	600		1000	600	
额定电流Rated Current [A]	125	150		150	150		125	150		232	230		309	285	
接线容量Wire Range [mm ²]	刚性Solid 1.5-50	柔性Fine Stranded 1.5-35	带冷压头Furrule 1.5-35	刚性Solid 16-70	柔性Fine Stranded 16-70	带冷压头Furrule 25-50	刚性Solid 25-70	柔性Fine Stranded 25-70	带冷压头Furrule 25-70	刚性Solid 25-95	柔性Fine Stranded 35-95	带冷压头Furrule 35-95	刚性Solid 35-150	柔性Fine Stranded 50-150	带冷压头Furrule 50-150
接线容量Wire Range [AWG]	16-1/0	16-1/0	16-1/0	6-2/0	6-2/0	6-2/0	4-3/0	4-3/0	4-3/0	4-3/0	4-3/0	4-3/0	2-300kcmil		
螺钉类型Screw Type [°]	M6			M6			M8 (内六角 Inner six angle)			M8 (内六角 Inner six angle)			M10 (内六角 Inner six angle)		
扭矩Torque [N.m]	3.0			6			6			15			25		
其余参数Other Parameters	V0			V0			V0			V0			V0		
绝缘材料/阻燃等级, 符合UL94 Insulating Material / Flame Retardant Grade, Conforming To UL94	17-18			24			24			33			40		
剥线长度Strip length [mm]	订货信息Order Information			订货信息Order Information			订货信息Order Information			订货信息Order Information			订货信息Order Information		
产品Product	颜色Colour	订货号Order NO.		订货号Order NO.		订货号Order NO.		订货号Order NO.		订货号Order NO.		订货号Order NO.		订货号Order NO.	
适配NS 35/7.5导轨 Can Be Used For DIN Rail NS 35/7.5	灰Gray	TU35-2-GY		TU50-2-GY		TU70-2-GY		TU95-2-GY		TU150-2-GY		TU150-2-GY		TU150-2-GY	
	橙Orange	TU35-2-OG		TU50-2-OG		TU70-2-OG		TU95-2-OG		TU150-2-OG		TU150-2-OG		TU150-2-OG	
	蓝Blue	TU35-2-BU		TU50-2-BU		TU70-2-BU		TU95-2-BU		TU150-2-BU		TU150-2-BU		TU150-2-BU	
盖板Cover Plate	颜色Colour	配套附件Accessory		配套附件Accessory		配套附件Accessory		配套附件Accessory		配套附件Accessory		配套附件Accessory		配套附件Accessory	
盖板Cover Plate	灰Gray	订货号Order NO.		订货号Order NO.		订货号Order NO.		订货号Order NO.		订货号Order NO.		订货号Order NO.		订货号Order NO.	
	橙Orange	*		*		*		*		*		*		*	
跨接件Jumper		订货号Order NO.		订货号Order NO.		订货号Order NO.		订货号Order NO.		订货号Order NO.		订货号Order NO.		订货号Order NO.	
极数Poles No.		TJA16-2		*		*		*		*		*		*	
2		*		*		*		*		*		*		*	
3		*		*		*		*		*		*		*	
4		*		*		*		*		*		*		*	
5		*		*		*		*		*		*		*	
6		*		*		*		*		*		*		*	
7		*		*		*		*		*		*		*	
8		*		*		*		*		*		*		*	
9		*		*		*		*		*		*		*	
10		*		*		*		*		*		*		*	
正面标记(小)Front Marker(Small)		订货号Order NO.		订货号Order NO.		订货号Order NO.		订货号Order NO.		订货号Order NO.		订货号Order NO.		订货号Order NO.	
可提供印字服务Printing Service		TMB10.2-10		TMB10.2-10		TMB10.2-10		TMB10.2-10		TMB10.2-10		TMB10.2-10		TMB10.2-10	
正面标记(大)Front Marker(Big)		订货号Order NO.		订货号Order NO.		订货号Order NO.		订货号Order NO.		订货号Order NO.		订货号Order NO.		订货号Order NO.	
可提供印字服务Printing Service		310801		310801		308801		310801		310801		310801		310801	

TU系列螺钉接线端子 TU Rail-mounted terminal blocks with screw clamp

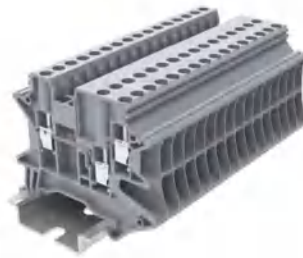

240mm² TU接线端子
TU Terminal Block

2.5mm² TU接线端子
TU Terminal Block

4mm² TU接线端子
TU Terminal Block

2.5mm² TU接线端子
TU Terminal Block

4mm² TU接线端子
Ground Terminal Block

尺寸Size	
注: 安装NS35/7.5导轨后的高度 Note: Height With DIN Rail NS 35/7.5	[mm]
额定电压Rated Voltage	[V]
额定电流Rated Current	[A]
接线容量Wire Range	
	[mm²]
	[AWG]
螺钉类型Screw Type	[*]
扭矩Torque	[N.m]
其余参数Other Parameters	
绝缘材料/阻燃等级, 符合UL94 Insulating Material / Flame Retardant Grade, Conforming To UL94	
剥线长度Strip length	[mm]
产品Product	
颜色Colour	
适配NS 35/7.5导轨 Can Be Used For DIN Rail NS 35/7.5	灰Gray 橙Orange 蓝Blue
盖板Cover Plate	
颜色Colour	
盖板Cover Plate	灰Gray 橙Orange
跨接件Jumper	
极数Poles No.	
2	
3	
4	
5	
6	
7	
8	
9	
10	
正面标记(小)Front Marker(Small) 可提供印字服务Printing Service	
正面标记(大)Front Marker(Big) 可提供印字服务Printing Service	

技术参数Technical Parameter		
厚度Thickness	宽度Width	高度Height
37.6	100	126
IEC	UL	
1000	600	
415	380	
刚性Solid	柔性Fine Stranded	带冷压头Furrule
70-240	70-240	70-185
2/0-500kcmil		
M8 (内六角 Inner six angle)		
6		
V0		
40		

订货信息Order Information	
订货号Order NO.	TU240-2-GY TU240-2-OG TU240-2-BU

配套附件Accessory	
订货号Order NO.	*
盖板Cover Plate	*

跨接件Jumper	
极数Poles No.	订货号Order NO.
2	*
3	*
4	*
5	*
6	*
7	*
8	*
9	*
10	*

正面标记(小)Front Marker(Small) 可提供印字服务Printing Service	订货号Order NO. TMB10.2-10
正面标记(大)Front Marker(Big) 可提供印字服务Printing Service	订货号Order NO. 310801

技术参数Technical Parameter		
厚度Thickness	宽度Width	高度Height
5.2	56.8	46.2
IEC	UL	
1000	600	
24	20	
刚性Solid	柔性Fine Stranded	带冷压头Furrule
0.2-4	0.2-2.5	0.25-2.5
26-12	26-12	26-12
M2.5		
0.4		
V0		
9-11		

订货信息Order Information	
订货号Order NO.	TU2.5-3-GY TU2.5-3-OG TU2.5-3-BU

配套附件Accessory	
订货号Order NO.	TU2.5-3-GY-EA TU2.5-3-OG-EA

跨接件Jumper	
极数Poles No.	订货号Order NO.
2	TJA5.2-2
3	TJA5.2-3
4	TJA5.2-4
5	TJA5.2-5
6	TJA5.2-6
7	TJA5.2-7
8	TJA5.2-8
9	TJA5.2-9
10	TJA5.2-10

正面标记(小)Front Marker(Small) 可提供印字服务Printing Service	订货号Order NO. TMB5.2-120
正面标记(大)Front Marker(Big) 可提供印字服务Printing Service	订货号Order NO. 305801

技术参数Technical Parameter		
厚度Thickness	宽度Width	高度Height
6.2	56.8	46.2
IEC	UL	
800	600	
32	30	
刚性Solid	柔性Fine Stranded	带冷压头Furrule
0.2-6	0.2-4	0.2-4
26-10	26-10	26-10
M3		
0.5		
V0		
8-9		

订货信息Order Information	
订货号Order NO.	TU4-3-GY TU4-3-OG TU4-3-BU

配套附件Accessory	
订货号Order NO.	TU2.5-3-GY-EA TU2.5-3-OG-EA

跨接件Jumper	
极数Poles No.	订货号Order NO.
2	TJA6.2-2
3	TJA6.2-3
4	TJA6.2-4
5	TJA6.2-5
6	TJA6.2-6
7	TJA6.2-7
8	TJA6.2-8
9	TJA6.2-9
10	TJA6.2-10

正面标记(小)Front Marker(Small) 可提供印字服务Printing Service	订货号Order NO. TMB6.2-100
正面标记(大)Front Marker(Big) 可提供印字服务Printing Service	订货号Order NO. 306801

技术参数Technical Parameter		
厚度Thickness	宽度Width	高度Height
5.2	64.2	46.2
IEC	UL	
1000	600	
24	20	
刚性Solid	柔性Fine Stranded	带冷压头Furrule
0.2-4	0.2-2.5	0.25-2.5
26-12	26-12	26-12
M2.5		
0.4		
V0		
9-11		

订货信息Order Information	
订货号Order NO.	TU2.5-4-GY TU2.5-4-OG TU2.5-4-BU

配套附件Accessory	
订货号Order NO.	TU2.5-4-GY-EA TU2.5-4-OG-EA

跨接件Jumper	
极数Poles No.	订货号Order NO.
2	TJA5.2-2
3	TJA5.2-3
4	TJA5.2-4
5	TJA5.2-5
6	TJA5.2-6
7	TJA5.2-7
8	TJA5.2-8
9	TJA5.2-9
10	TJA5.2-10

正面标记(小)Front Marker(Small) 可提供印字服务Printing Service	订货号Order NO. TMB5.2-120
正面标记(大)Front Marker(Big) 可提供印字服务Printing Service	订货号Order NO. 305801

技术参数Technical Parameter		
厚度Thickness	宽度Width	高度Height
6.2	64.2	46.2
IEC	UL	
1000	600	
32	30	
刚性Solid	柔性Fine Stranded	带冷压头Furrule
0.2-6	0.2-4	0.2-4
26-10	26-10	26-10
M3		
0.5		
V0		
8-9		

订货信息Order Information	
订货号Order NO.	TU4-4-GY TU4-4-OG TU4-4-BU

配套附件Accessory	
订货号Order NO.	TU2.5-4-GY-EA TU2.5-4-OG-EA

跨接件Jumper	
极数Poles No.	订货号Order NO.
2	TJA6.2-2
3	TJA6.2-3
4	TJA6.2-4
5	TJA6.2-5
6	TJA6.2-6
7	TJA6.2-7
8	TJA6.2-8
9	TJA6.2-9
10	TJA6.2-10

正面标记(小)Front Marker(Small) 可提供印字服务Printing Service	订货号Order NO. TMB6.2-100
正面标记(大)Front Marker(Big) 可提供印字服务Printing Service	订货号Order NO. 306801

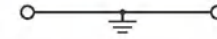
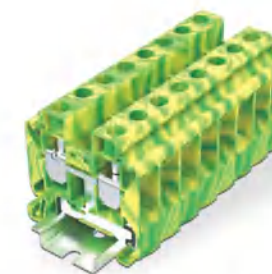
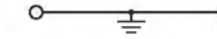
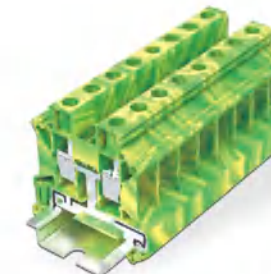
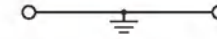
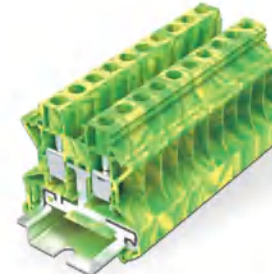
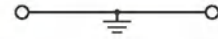
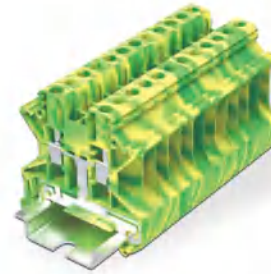
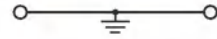

2.5mm² TU接地端子
TU Ground Terminal Block

4mm² TU接地端子
TU Ground Terminal Block

6mm² TU接地端子
TU Ground Terminal Block

10mm² TU接地端子
TU Ground Terminal Block

16mm² TU接地端子
TU Ground Terminal Block

尺寸Size	2.5mm ² TU接地端子 TU Ground Terminal Block			4mm ² TU接地端子 TU Ground Terminal Block			6mm ² TU接地端子 TU Ground Terminal Block			10mm ² TU接地端子 TU Ground Terminal Block			16mm ² TU接地端子 TU Ground Terminal Block			
	厚度Thickness	宽度Width	高度Height	厚度Thickness	宽度Width	高度Height	厚度Thickness	宽度Width	高度Height	厚度Thickness	宽度Width	高度Height	厚度Thickness	宽度Width	高度Height	
注: 安装NS35/7.5导轨后的高度 Note: Height With DIN Rail NS 35/7.5	[mm]	5.2	47.3	46.2	6.2	47.3	46.2	8.2	47.3	46.2	10.2	47.3	46.2	12.2	52.8	54.35
额定电压Rated Voltage	[V]	*	*	*	*	*	*	*	*	*	*	*	*	*	*	*
额定电流Rated Current	[A]	*	*	*	*	*	*	*	*	*	*	*	*	*	*	*
接线容量Wire Range	[mm ²]	0.2-4	0.2-2.5	0.25-2.5	0.2-6	0.2-4	0.2-4	0.2-10	0.2-6	0.25-6	0.5-16	0.5-10	0.5-10	1.5-25	1.5-16	1.5-16
	[AWG]	26-12	26-12	26-12	26-10	26-10	26-10	24-8	24-8	24-8	20-6	20-6	20-6	16-4	16-4	16-4
螺钉类型Screw Type	[*]	M2.5			M3			M4			M4			M5		
扭矩Torque	[N.m]	0.4			0.5			1.2			1.2			2.0		
其余参数Other Parameters		V0			V0			V0			V0			V0		
绝缘材料/阻燃等级, 符合UL94 Insulating Material / Flame Retardant Grade, Conforming To UL94		V0			V0			V0			V0			V0		
剥线长度Strip length	[mm]	8-9			8-9			9-10			10-11			13-14		
产品Product	颜色Colour	订货号Order NO.			订货号Order NO.			订货号Order NO.			订货号Order NO.			订货号Order NO.		
适配NS 35/7.5导轨 Can Be Used For DIN Rail NS 35/7.5	黄绿Yellow green	TU2.5-2-PE			TU4-2-PE			TU6-2-PE			TU10-2-PE			TU16-2-PE		
盖板Cover Plate	颜色Colour	订货号Order NO.			订货号Order NO.			订货号Order NO.			订货号Order NO.			订货号Order NO.		
盖板Cover Plate	灰Gray	TU2.5-2-GY-EA			TU2.5-2-GY-EA			TU2.5-2-GY-EA			TU2.5-2-GY-EA			TU16-2-GY-EA		
盖板Cover Plate	橙Orange	TU2.5-2-OG-EA			TU2.5-2-OG-EA			TU2.5-2-OG-EA			TU2.5-2-OG-EA			TU16-2-OG-EA		
跨接件Jumper		订货号Order NO.			订货号Order NO.			订货号Order NO.			订货号Order NO.			订货号Order NO.		
极数Poles No.		订货号Order NO.			订货号Order NO.			订货号Order NO.			订货号Order NO.			订货号Order NO.		
	2	*			*			*			*			*		
	3	*			*			*			*			*		
	4	*			*			*			*			*		
	5	*			*			*			*			*		
	6	*			*			*			*			*		
	7	*			*			*			*			*		
	8	*			*			*			*			*		
	9	*			*			*			*			*		
	10	*			*			*			*			*		
正面标记(小)Front Marker(Small)		订货号Order NO.			订货号Order NO.			订货号Order NO.			订货号Order NO.			订货号Order NO.		
可提供印字服务Printing Service		TMB5.2-120			TMB6.2-100			TMB8.2-50			TMB10.2-10			TMB10.2-10		
正面标记(大)Front Marker(Big)		订货号Order NO.			订货号Order NO.			订货号Order NO.			订货号Order NO.			订货号Order NO.		
可提供印字服务Printing Service		305801			306801			308801			310801			310801		

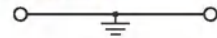

35mm² TU接地端子
TU Ground Terminal Block

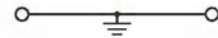
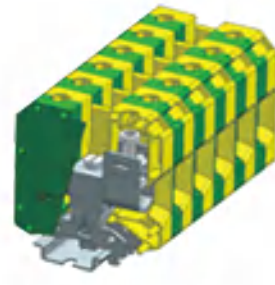

50mm² TU接地端子
TU Ground Terminal Block

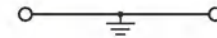

95mm² TU接地端子
TU Ground Terminal Block

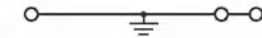

2.5mm² TU接地端子
TU Ground Terminal Block

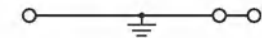

4mm² TU接地端子
TU Ground Terminal Block

尺寸Size	
注: 安装NS35/7.5导轨后的高度 Note: Height With DIN Rail NS 35/7.5	[mm]
额定电压Rated Voltage	[V]
额定电流Rated Current	[A]
接线容量Wire Range	
	[mm ²]
	[AWG]
螺钉类型Screw Type	[*]
扭矩Torque	[N.m]
其余参数Other Parameters	
绝缘材料/阻燃等级, 符合UL94 Insulating Material / Flame Retardant Grade, Conforming To UL94	
剥线长度Strip length	[mm]
产品Product	
颜色Colour	黄绿Yellow green
适配NS 35/7.5导轨 Can Be Used For DIN Rail NS 35/7.5	
盖板Cover Plate	
颜色Colour	灰Gray / 橙Orange
跨接件Jumper	
极数Poles No.	
2	
3	
4	
5	
6	
7	
8	
9	
10	
正面标记(小)Front Marker(Small)	
可提供印字服务Printing Service	
正面标记(大)Front Marker(Big)	
可提供印字服务Printing Service	

技术参数Technical Parameter		
厚度Thickness	宽度Width	高度Height
16	59.2	65.05
额定参数Rated Parameters		
IEC	UL	
*	*	
*	*	
接线容量Wire Range		
刚性Solid	柔性Fine Stranded	带冷压头Furrule
1.5-50	1.5-35	1.5-35
16-1/0	16-1/0	16-1/0
M6		
3.0		
V0		
17-18		

订货信息Order Information	
订货号Order NO.	TU35-2-PE

配套附件Accessory	
订货号Order NO.	*
	*

跨接件Jumper	
订货号Order NO.	*
	*
	*
	*
	*
	*
	*
	*
	*
	*

正面标记(小)Front Marker(Small)	订货号Order NO.	TMB10.2-10
正面标记(大)Front Marker(Big)	订货号Order NO.	310801

技术参数Technical Parameter		
厚度Thickness	宽度Width	高度Height
20.4	70.7	76.1
额定参数Rated Parameters		
IEC	UL	
*	*	
*	*	
接线容量Wire Range		
刚性Solid	柔性Fine Stranded	带冷压头Furrule
16-70	16-70	25-50
6-2/0	6-2/0	6-2/0
M6		
6		
V0		
24		

订货信息Order Information	
订货号Order NO.	TU50-2-PE

配套附件Accessory	
订货号Order NO.	*
	*

跨接件Jumper	
订货号Order NO.	*
	*
	*
	*
	*
	*
	*
	*
	*
	*

正面标记(小)Front Marker(Small)	订货号Order NO.	TMB10.2-10
正面标记(大)Front Marker(Big)	订货号Order NO.	310801

技术参数Technical Parameter		
厚度Thickness	宽度Width	高度Height
25	83.2	90.1
额定参数Rated Parameters		
IEC	UL	
*	*	
*	*	
接线容量Wire Range		
刚性Solid	柔性Fine Stranded	带冷压头Furrule
25-95	35-95	35-95
4-3/0	4-3/0	4-3/0
M8 (内六角 Inner six angle)		
15		
V0		
33		

订货信息Order Information	
订货号Order NO.	TU95-2-PE

配套附件Accessory	
订货号Order NO.	*
	*

跨接件Jumper	
订货号Order NO.	*
	*
	*
	*
	*
	*
	*
	*
	*
	*

正面标记(小)Front Marker(Small)	订货号Order NO.	TMB10.2-10
正面标记(大)Front Marker(Big)	订货号Order NO.	310801

技术参数Technical Parameter		
厚度Thickness	宽度Width	高度Height
5.2	56.8	47
额定参数Rated Parameters		
IEC	UL	
*	*	
*	*	
接线容量Wire Range		
刚性Solid	柔性Fine Stranded	带冷压头Furrule
0.2-4	0.2-2.5	0.25-2.5
26-12	26-12	26-12
M2.5		
0.4		
V0		
9-11		

订货信息Order Information	
订货号Order NO.	TU2.5-3-PE

配套附件Accessory	
订货号Order NO.	TU2.5-3-GY-EA
	TU2.5-3-OG-EA

跨接件Jumper	
订货号Order NO.	*
	*
	*
	*
	*
	*
	*
	*
	*
	*

正面标记(小)Front Marker(Small)	订货号Order NO.	TMB5.2-120
正面标记(大)Front Marker(Big)	订货号Order NO.	305801

技术参数Technical Parameter		
厚度Thickness	宽度Width	高度Height
6.2	56.8	47
额定参数Rated Parameters		
IEC	UL	
*	*	
*	*	
接线容量Wire Range		
刚性Solid	柔性Fine Stranded	带冷压头Furrule
0.2-6	0.2-4	0.2-4
26-10	26-10	26-10
M3		
0.5		
V0		
8-9		

订货信息Order Information	
订货号Order NO.	TU4-3-PE

配套附件Accessory	
订货号Order NO.	TU2.5-3-GY-EA
	TU2.5-3-OG-EA

跨接件Jumper	
订货号Order NO.	*
	*
	*
	*
	*
	*
	*
	*
	*
	*

正面标记(小)Front Marker(Small)	订货号Order NO.	TMB6.2-100
正面标记(大)Front Marker(Big)	订货号Order NO.	306801

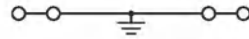
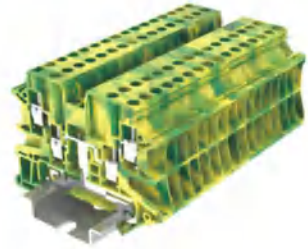

2.5mm² TU接地端子
TU Ground Terminal Block

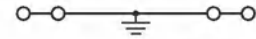

4mm² TU接地端子
TU Ground Terminal Block

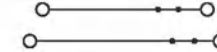

2.5mm², 双层接线端子
Double level terminal block



2.5mm², 双层等电位接线端子
Double level terminal block with equipotential bond

尺寸Size	
注: 安装NS35/7.5导轨后的高度 Note: Height With DIN Rail NS 35/7.5	[mm]
额定电压Rated Voltage	[V]
额定电流Rated Current	[A]
接线容量Wire Range	
	[mm²]
	[AWG]
螺钉类型Screw Type	[*]
扭矩Torque	[N.m]
其余参数Other Parameters	
绝缘材料/阻燃等级, 符合UL94 Insulating Material / Flame Retardant Grade, Conforming To UL94	
剥线长度Strip length	[mm]

技术参数Technical Parameter		
厚度Thickness	宽度Width	高度Height
5.2	59.2	47
额定参数Rated Parameters		
IEC	UL	
*	*	
*	*	
接线容量Wire Range		
刚性Solid	柔性Fine Stranded	带冷压头Furrule
0.2-4	0.2-2.5	0.25-2.5
26-12	26-12	26-12
M2.5		
0.4		
V0		
9-11		

技术参数Technical Parameter		
厚度Thickness	宽度Width	高度Height
6.2	70.7	47
额定参数Rated Parameters		
IEC	UL	
*	*	
*	*	
接线容量Wire Range		
刚性Solid	柔性Fine Stranded	带冷压头Furrule
0.2-6	0.2-4	0.2-4
26-10	26-10	26-10
M3		
0.5		
V0		
8-9		

产品Product	
颜色Colour	黄绿Yellow green
适配NS 35/7.5导轨 Can Be Used For DIN Rail NS 35/7.5	

订货信息Order Information	
订货号Order NO.	TU2.5-4-PE

订货信息Order Information	
订货号Order NO.	TU4-4-PE

盖板Cover Plate	
颜色Colour	灰Gray
盖板Cover Plate	橙Orange

配套附件Accessory	
订货号Order NO.	TU2.5-4-GY-EA
	TU2.5-4-OG-EA

配套附件Accessory	
订货号Order NO.	TU2.5-4-GY-EA
	TU2.5-4-OG-EA

跨接件Jumper	
极数Poles No.	
2	*
3	*
4	*
5	*
6	*
7	*
8	*
9	*
10	*

跨接件Jumper	
极数Poles No.	
2	*
3	*
4	*
5	*
6	*
7	*
8	*
9	*
10	*

跨接件Jumper	
极数Poles No.	
2	*
3	*
4	*
5	*
6	*
7	*
8	*
9	*
10	*

正面标记(小)Front Marker(Small)	订货号Order NO.
可提供印字服务Printing Service	TMB5.2-120
正面标记(大)Front Marker(Big)	订货号Order NO.
可提供印字服务Printing Service	305801

正面标记(小)Front Marker(Small)	订货号Order NO.
可提供印字服务Printing Service	TMB6.2-100
正面标记(大)Front Marker(Big)	订货号Order NO.
可提供印字服务Printing Service	306801

正面标记(小)Front Marker(Small)	订货号Order NO.
可提供印字服务Printing Service	TMB5.2-120
正面标记(大)Front Marker(Big)	订货号Order NO.
可提供印字服务Printing Service	305801

尺寸Size	
注: 安装NS35/7.5导轨后的高度 Note: Height With DIN Rail NS 35/7.5	[mm]
额定电压Rated Voltage	[V]
额定电流Rated Current	[A]
接线容量Wire Range	
	[mm²]
	[AWG]
螺钉类型Screw Type	[*]
扭矩Torque	[N.m]
其余参数Other Parameters	
绝缘材料/阻燃等级, 符合UL94 Insulating Material / Flame Retardant Grade, Conforming To UL94	
剥线长度Strip length	[mm]

技术参数Technical Parameter		
厚度Thickness	宽度Width	高度Height
5.2	69.9	64.5
额定参数Rated Parameters		
IEC	UL	
800	600	
24	20	
接线容量Wire Range		
刚性Solid	柔性Fine Stranded	带冷压头Furrule
0.2-4	0.2-2.5	0.25-2.5
26-12	26-12	26-12
M2.5		
0.4		
V0		
9-11		

技术参数Technical Parameter		
厚度Thickness	宽度Width	高度Height
5.2	69.9	64.5
额定参数Rated Parameters		
IEC	UL	
800	600	
24	20	
接线容量Wire Range		
刚性Solid	柔性Fine Stranded	带冷压头Furrule
0.2-4	0.2-2.5	0.25-2.5
26-12	26-12	26-12
M2.5		
0.4		
V0		
9-11		

产品Product	
颜色Colour	灰Gray
	橙Orange
	蓝Blue
适配NS 35/7.5导轨 Can Be Used For DIN Rail NS 35/7.5	

订货信息Order Information	
订货号Order NO.	TUD2.5-2-GY
	TUD2.5-2-OG
	TUD2.5-2-BL

订货信息Order Information	
订货号Order NO.	TUD2.5-2-PV (黑色)

盖板Cover Plate	
颜色Colour	灰Gray
盖板Cover Plate	橙Orange

配套附件Accessory	
订货号Order NO.	TUD2.5-2-GY-EA
	TUD2.5-2-OG-EA

配套附件Accessory	
订货号Order NO.	TUD2.5-2-GY-EA
	TUD2.5-2-OG-EA

跨接件Jumper	
极数Poles No.	
2	TJA5.2-2
3	TJA5.2-3
4	TJA5.2-4
5	TJA5.2-5
6	TJA5.2-6
7	TJA5.2-7
8	TJA5.2-8
9	TJA5.2-9
10	TJA5.2-10

跨接件Jumper	
极数Poles No.	
2	TJA5.2-2
3	TJA5.2-3
4	TJA5.2-4
5	TJA5.2-5
6	TJA5.2-6
7	TJA5.2-7
8	TJA5.2-8
9	TJA5.2-9
10	TJA5.2-10

跨接件Jumper	
极数Poles No.	
2	TJA5.2-2
3	TJA5.2-3
4	TJA5.2-4
5	TJA5.2-5
6	TJA5.2-6
7	TJA5.2-7
8	TJA5.2-8
9	TJA5.2-9
10	TJA5.2-10

正面标记(小)Front Marker(Small)	订货号Order NO.
可提供印字服务Printing Service	TMB5.2-120
正面标记(大)Front Marker(Big)	订货号Order NO.
可提供印字服务Printing Service	305801

正面标记(小)Front Marker(Small)	订货号Order NO.
可提供印字服务Printing Service	TMB5.2-120
正面标记(大)Front Marker(Big)	订货号Order NO.
可提供印字服务Printing Service	305801

正面标记(小)Front Marker(Small)	订货号Order NO.
可提供印字服务Printing Service	TMB5.2-120
正面标记(大)Front Marker(Big)	订货号Order NO.
可提供印字服务Printing Service	305801

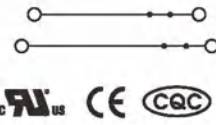

4mm², 双层接线端子
Double level terminal block

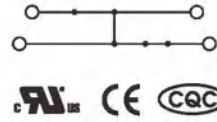

4mm², 双层等电位接线端子
Double level terminal block with equipotential bond

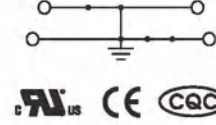
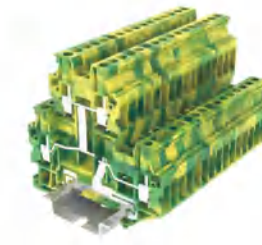

2.5mm², 双层接地端子
Double level ground terminal block

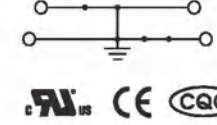

4mm², 双层接地端子
Double level ground terminal block

尺寸Size	
注: 安装NS35/7.5导轨后的高度 Note: Height With DIN Rail NS 35/7.5	[mm]
额定电压Rated Voltage	[V]
额定电流Rated Current	[A]
接线容量Wire Range	
	[mm²]
	[AWG]
螺钉类型Screw Type	[*]
扭矩Torque	[N.m]
其余参数Other Parameters	
绝缘材料/阻燃等级, 符合UL94 Insulating Material / Flame Retardant Grade, Conforming To UL94	
剥线长度Strip length	[mm]

技术参数Technical Parameter		
厚度Thickness	宽度Width	高度Height
6.2	69.9	64.5
额定参数Rated Parameters		
IEC	UL	
800	600	
32	30	
接线容量Wire Range		
刚性Solid	柔性Fine Stranded	带冷压头Furrule
0.2-6	0.2-4	0.2-4
26-10	26-10	26-10
M3		
0.5		
V0		
9-11		

技术参数Technical Parameter		
厚度Thickness	宽度Width	高度Height
6.2	69.9	64.5
额定参数Rated Parameters		
IEC	UL	
800	600	
32	30	
接线容量Wire Range		
刚性Solid	柔性Fine Stranded	带冷压头Furrule
0.2-6	0.2-4	0.2-4
26-10	26-10	26-10
M3		
0.5		
V0		
9-11		

尺寸Size	
注: 安装NS35/7.5导轨后的高度 Note: Height With DIN Rail NS 35/7.5	[mm]
额定电压Rated Voltage	[V]
额定电流Rated Current	[A]
接线容量Wire Range	
	[mm²]
	[AWG]
螺钉类型Screw Type	[*]
扭矩Torque	[N.m]
其余参数Other Parameters	
绝缘材料/阻燃等级, 符合UL94 Insulating Material / Flame Retardant Grade, Conforming To UL94	
剥线长度Strip length	[mm]

技术参数Technical Parameter		
厚度Thickness	宽度Width	高度Height
5.2	69.9	64.5
额定参数Rated Parameters		
IEC	UL	
*	*	
*	*	
接线容量Wire Range		
带冷压头Furrule	柔性Fine Stranded	刚性Solid
0.2-4	0.2-2.5	0.25-2.5
26-12	26-12	26-12
M2.5		
0.4		
V0		
9-11		

技术参数Technical Parameter		
厚度Thickness	宽度Width	高度Height
6.2	69.9	64.5
额定参数Rated Parameters		
IEC	UL	
*	*	
*	*	
接线容量Wire Range		
带冷压头Furrule	柔性Fine Stranded	刚性Solid
0.2-6	0.2-4	0.25-4
26-12	26-10	26-10
M3		
0.5		
V0		
9-11		

产品Product	
颜色Colour	
适配NS 35/7.5导轨 Can Be Used For DIN Rail NS 35/7.5	灰Gray 橙Orange 蓝Blue

订货信息Order Information	
订货号Order NO.	
TUD4-2-GY	
TUD4-2-OG	
TUD4-2-BL	

订货信息Order Information	
订货号Order NO.	
TUD4-2-PV (黑色)	

盖板Cover Plate	
颜色Colour	
盖板Cover Plate	灰Gray 橙Orange

配套附件Accessory	
订货号Order NO.	
TUD2.5-2-GY-EA	
TUD2.5-2-OG-EA	

配套附件Accessory	
订货号Order NO.	
TUD2.5-2-GY-EA	
TUD2.5-2-OG-EA	

跨接件Jumper	
极数Poles No.	
2	
3	
4	
5	
6	
7	
8	
9	
10	

订货信息Order NO.	
订货号Order NO.	
TJA6.2-2	
TJA6.2-3	
TJA6.2-4	
TJA6.2-5	
TJA6.2-6	
TJA6.2-7	
TJA6.2-8	
TJA6.2-9	
TJA6.2-10	

订货信息Order NO.	
订货号Order NO.	
TJA6.2-2	
TJA6.2-3	
TJA6.2-4	
TJA6.2-5	
TJA6.2-6	
TJA6.2-7	
TJA6.2-8	
TJA6.2-9	
TJA6.2-10	

正面标记(小)Front Marker(Small)	
可提供印字服务Printing Service	
正面标记(大)Front Marker(Big)	
可提供印字服务Printing Service	

订货号Order NO.	
订货号Order NO.	
TMB6.2-100	
订货号Order NO.	
306801	

订货号Order NO.	
订货号Order NO.	
TMB6.2-100	
订货号Order NO.	
306801	

产品Product	
颜色Colour	
适配NS 35/7.5导轨 Can Be Used For DIN Rail NS 35/7.5	黄绿Yellow green

订货信息Order Information	
订货号Order NO.	
TUD2.5-2-PE	

订货信息Order Information	
订货号Order NO.	
TUD4-2-PE	

盖板Cover Plate	
颜色Colour	
盖板Cover Plate	灰Gray 橙Orange

配套附件Accessory	
订货号Order NO.	
TUD2.5-2-GY-EA	
TUD2.5-2-OG-EA	

配套附件Accessory	
订货号Order NO.	
TUD2.5-2-GY-EA	
TUD2.5-2-OG-EA	

跨接件Jumper	
极数Poles No.	
2	
3	
4	
5	
6	
7	
8	
9	
10	

订货信息Order NO.	
订货号Order NO.	
*	
*	
*	
*	
*	
*	
*	
*	
*	

订货信息Order NO.	
订货号Order NO.	
*	
*	
*	
*	
*	
*	
*	
*	

正面标记(小)Front Marker(Small)	
可提供印字服务Printing Service	
正面标记(大)Front Marker(Big)	
可提供印字服务Printing Service	

订货号Order NO.	
订货号Order NO.	
TMB5.2-120	
订货号Order NO.	
305801	

订货号Order NO.	
订货号Order NO.	
TMB6.2-100	
订货号Order NO.	
306801	

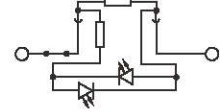
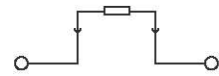

4mm²带保险管接线端子
Terminal block with protective tube

4mm²带发光二极管保险管接线端子
Terminal block with LED diode and protective tube

尺寸Size	
注: 安装NS35/7.5导轨后的高度 Note: Height With DIN Rail NS 35/7.5	[mm]
额定参数Rated Parameters	
额定电压Rated Voltage	[V]
额定电流Rated Current	[A]
接线容量Wire Range	
	[mm ²]
	[AWG]
螺钉类型Screw Type	[*]
扭矩Torque	[N.m]
其余参数Other Parameters	
绝缘材料/阻燃等级, 符合UL94 Insulating Material / Flame Retardant Grade, Conforming To UL94	
剥线长度Strip length	[mm]

技术参数Technical Parameter		
厚度Thickness	宽度Width	高度Height
8.2	53	43.2
IEC	UL	
800	600	
12	12	
刚性Solid	柔性Fine Stranded	带冷压头Furrule
0.2-4	0.2-4	0.2-4
22-10	22-10	22-10
M3		
0.5		
V0		
8-9		

技术参数Technical Parameter		
厚度Thickness	宽度Width	高度Height
8.2	53	43.2
IEC	UL	
800	600	
12	12	
刚性Solid	柔性Fine Stranded	带冷压头Furrule
0.2-4	0.2-4	0.2-4
22-10	22-10	22-10
M3		
0.5		
V0		
8-9		

订货信息Order Information

订货信息Order Information

订货信息Order Information

产品Product	颜色Colour
适配NS 35/7.5导轨 Can Be Used For DIN Rail NS 35/7.5	灰Gray

订货号Order NO.
TU4-HESI-GY

订货号Order NO.
TU4-HESILED24-GY

配套附件Accessory

配套附件Accessory

配套附件Accessory

盖板Cover Plate	颜色Colour
盖板Cover Plate	灰Gray

订货号Order NO.
TU4-HESI-GY-EA

订货号Order NO.
TU4-HESI-GY-EA

跨接件Jumper

跨接件Jumper

跨接件Jumper

极数Poles No.
2
3
4
5
6
7
8
9
10

订货号Order NO.
*
*
*
*
*
*
*
*
*

订货号Order NO.
*
*
*
*
*
*
*
*
*

正面标记(小)Front Marker(Small)
可提供印字服务Printing Service

订货号Order NO.
TMB8.2-50

订货号Order NO.
TMB8.2-50

正面标记(大)Front Marker(Big)
可提供印字服务Printing Service

订货号Order NO.
308801

订货号Order NO.
308801

TA系列弹簧接线端子

TA Rail-mounted Terminal Blocks With Spring-cage Clamp

TA系列弹簧接线端子采用笼式弹簧接线技术，可以将2-4根0.2-16mm²的导线建立起安全可靠的电力和信号连接，产品广泛应用于电梯、轨道交通、船舶、楼宇智能、重型设备及工业自动化等领域。产品设计制造符合IEC/EN60947、UL1059等相关国际标准。

TA series rail-mounted spring cage clamp terminal blocks use spring cage connection technology, make 2-4, 0.2-16mm² wire establish a secure and reliable electricity and signal connection. The products are widely used in elevators, rail transportations, ships, buildings, heavy equipments and industrial automations. Product design and manufacturing in line with relevant international standards such as IEC60947, UL1059.

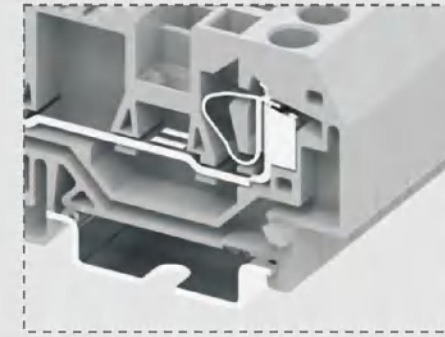
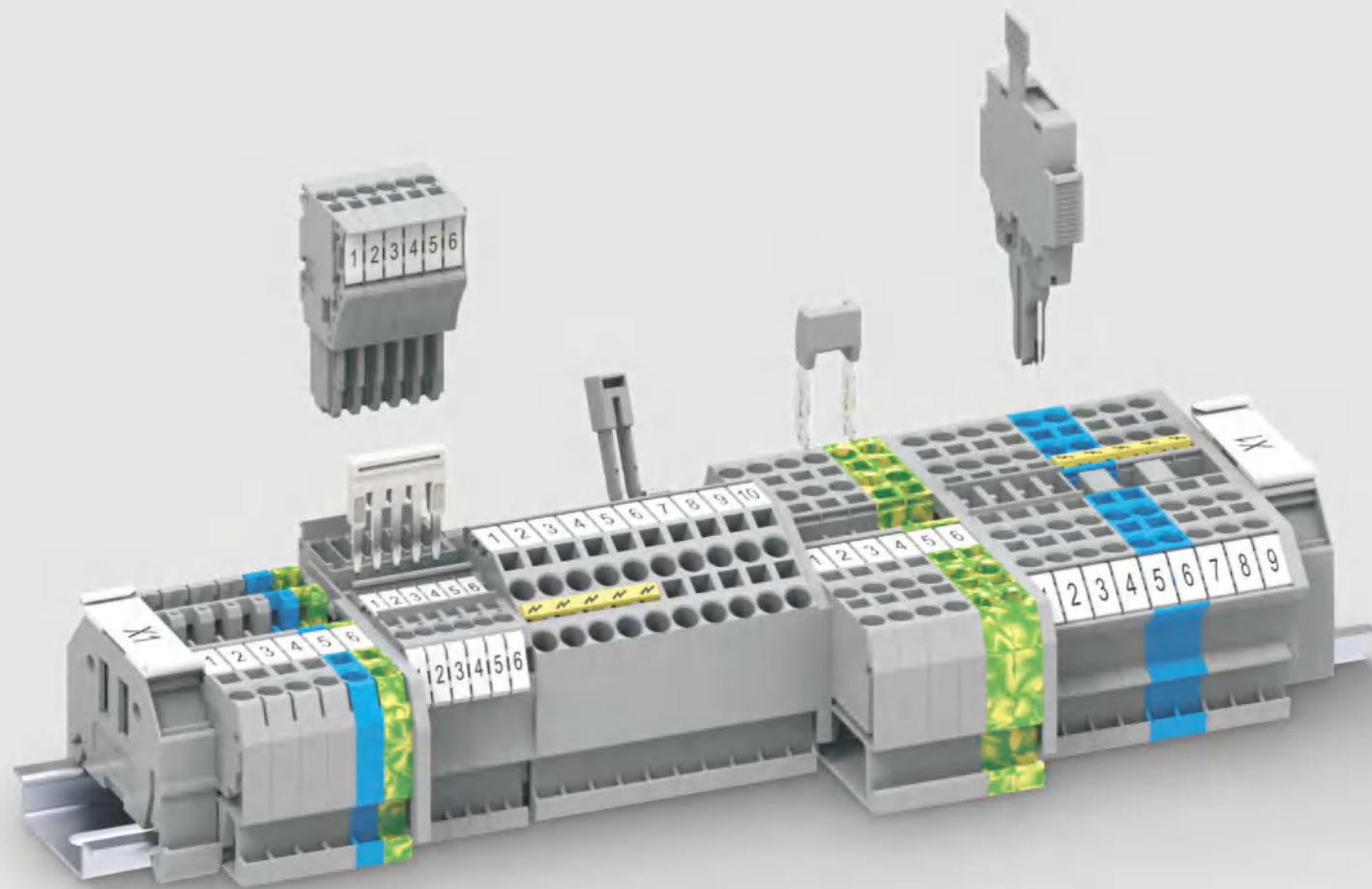

连接结构 Connection Structure

- ▲ 端子之间可相互连接固定
- ▲ Terminals can be connected to each other

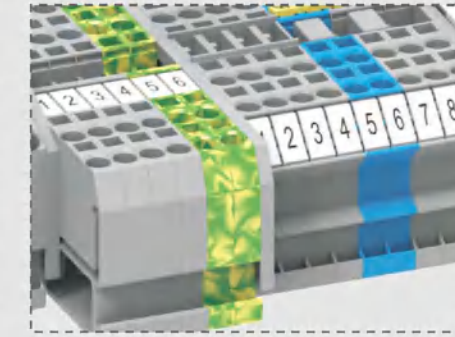

标识 Marking

- ▲ 具有正面标记与侧面标记两种标识，可适用于各种不同的空间环境
- ▲ Front marker and side marker can be used in the different space environments

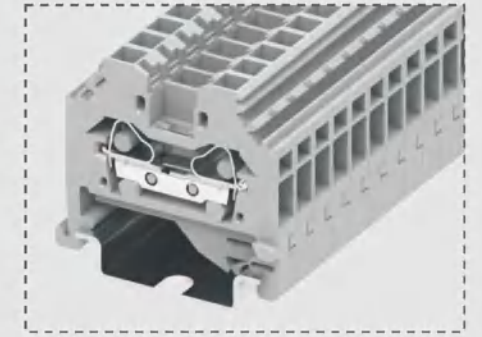

侧面接线 Side-entry wiring

- ▲ 从侧面接线，满足不同的空间环境下的接线方式
- ▲ Side-entry wiring can meet the connection in different space environments

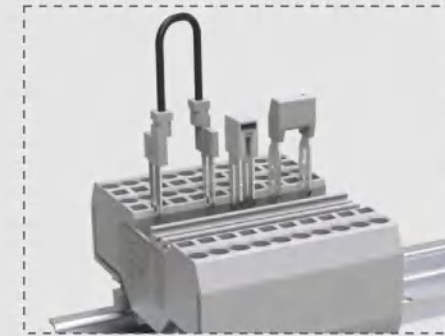

跨接件 Jumper

- ▲ 采用相邻跨接件、间隔跨接桥和导线跨接三种形式，可实现多种电路设计
- ▲ Adjacent jumpers, staggered jumpers and wire jumpers can realize multiple circuit designs

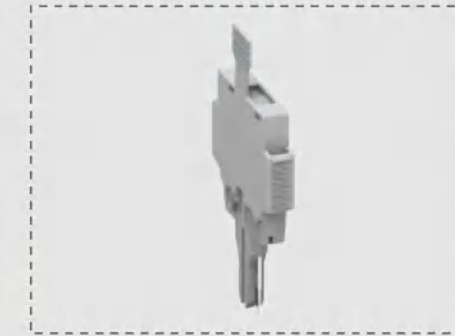

保险盒 Fuse Box

- ▲ 端子上可安装保险盒，保险盒内可安装保险管
- ▲ A fuse box can be installed on the terminal, and a fuse can be installed in the fuse box

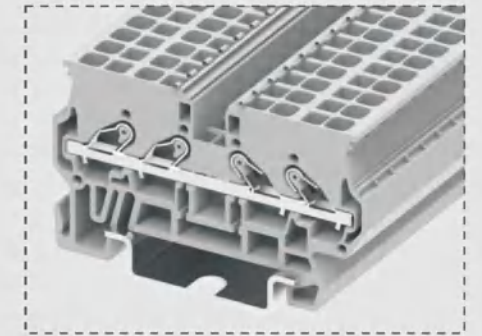

直插式端子 Straight Plug Type Terminal Block

- ▲ 无需借助特殊接线工具即可完成接线
- ▲ Wiring is done without special wiring tools

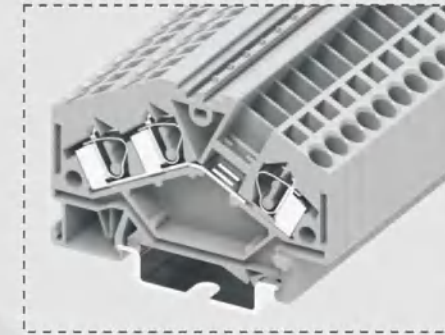

斜面端子 Angled Type Terminal Block

- ▲ 斜面型的设计减小了端子的外型尺寸，节省空间
- ▲ Angled type reduces the size of the terminal and saves space

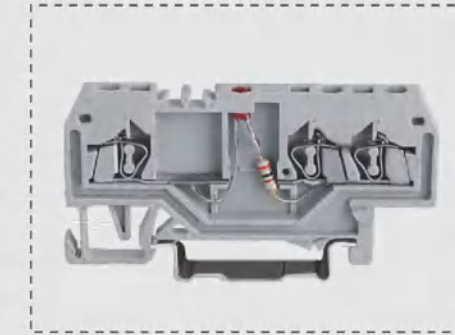

功能端子 Functional Terminal Block

- ▲ 带二极管和指示灯的接线端子，可方便实现各种不同的电路开关功能
- ▲ Wiring terminals with diodes and indicator lights for easy implementation of various circuit switching functions

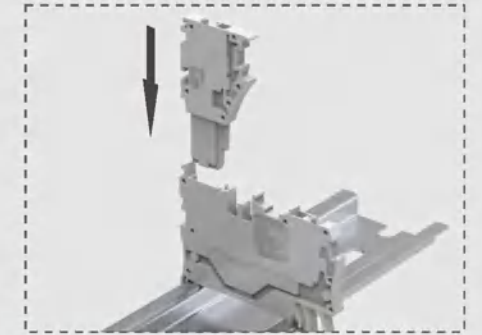

插拔式端子 Pluggable Terminal Block

- ▲ 将弹簧接线端子与插头相结合，提供灵活的接线方式
- ▲ Plug-in terminal blocks and female plugs provide the flexible wiring

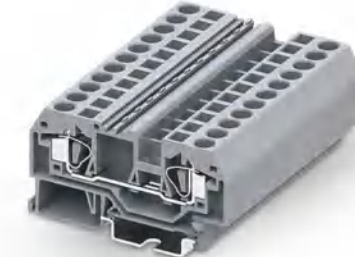
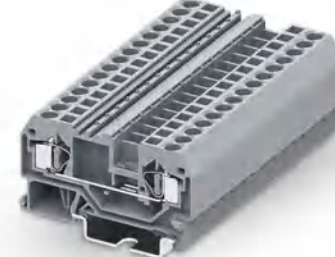
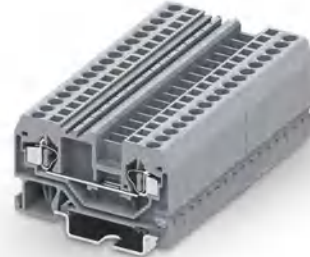
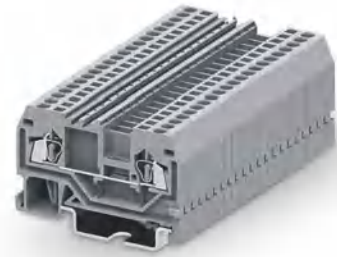
1.5mm² 一进一出接线端子
1-1 Feed Through Terminal Block2.5mm² 一进一出接线端子
1-1 Feed Through Terminal Block4mm² 一进一出接线端子
1-1 Feed Through Terminal Block6mm² 一进一出接线端子
1-1 Feed Through Terminal Block10mm² 一进一出接线端子
1-1 Feed Through Terminal Block

尺寸Size	技术参数Technical Parameter			技术参数Technical Parameter			技术参数Technical Parameter			技术参数Technical Parameter			技术参数Technical Parameter			
	厚度Thickness	宽度Width	高度Height	厚度Thickness	宽度Width	高度Height	厚度Thickness	宽度Width	高度Height	厚度Thickness	宽度Width	高度Height	厚度Thickness	宽度Width	高度Height	
注: 安装NS35/7.5导轨后的高度 Note: Height With DIN Rail NS 35/7.5	[mm]	4	51.6	34.5	5	52.8	35.3	6	59	36	8	73.6	40	10	76.7	42.5
额定参数Rated Parameters		IEC	UL		IEC	UL		IEC	UL		IEC	UL		IEC	UL	
额定电压Rated Voltage	[V]	800	600		800	600		800	600		800	600		800	600	
额定电流Rated Current	[A]	18	10		24	20		32	20		41	30		57	50	
接线容量Wire Range		刚性Solid	柔性Fine Stranded	带冷压头Furrule	刚性Solid	柔性Fine Stranded	带冷压头Furrule	刚性Solid	柔性Fine Stranded	带冷压头Furrule	刚性Solid	柔性Fine Stranded	带冷压头Furrule	刚性Solid	柔性Fine Stranded	带冷压头Furrule
	[mm ²]	0.2-1.5	0.2-1.5	0.2-1	0.2-2.5	0.2-2.5	0.2-1.5	0.2-4	0.2-4	0.2-2.5	0.2-6	0.2-6	0.2-4	0.2-10	0.2-10	0.2-6
	[AWG]	28-16	28-16	28-16	28-14	28-14	28-14	28-12	28-12	28-12	28-10	28-10	28-10	28-8	28-8	28-8
其余参数Other Parameters		绝缘材料/阻燃等级, 符合UL94 Insulating Material / Flame Retardant Grade, Conforming To UL94			V0			V0			V0			V0		
剥线长度Strip length	[mm]	8-9			8-9			9-10			12-13			12-13		
产品Product	颜色Colour	订货信息Order Information			订货信息Order Information			订货信息Order Information			订货信息Order Information			订货信息Order Information		
适配NS 35/7.5导轨 Can Be Used For DIN Rail NS 35/7.5	灰Gray	订货号Order NO.			订货号Order NO.			订货号Order NO.			订货号Order NO.			订货号Order NO.		
	橙Orange	215921			225921			204921			206921			210921		
	蓝Blue	215922			225922			204922			206922			210922		
		215924			225924			204924			206923			210923		
端板Cover Plate		配套附件Accessory			配套附件Accessory			配套附件Accessory			配套附件Accessory			配套附件Accessory		
	灰Gray	订货号Order NO.			订货号Order NO.			订货号Order NO.			订货号Order NO.			订货号Order NO.		
	橙Orange	215121			225121			204121			206121			210121		
	*	215122			225122			204122			206122			210122		
		*			*			*			*			*		
跨接件Jumper	颜色Colour	订货号Order NO.			订货号Order NO.			订货号Order NO.			订货号Order NO.			订货号Order NO.		
	灰Gray	215301			225301			204301			206301			210301		
相邻跨接桥Adjacent Jumper		*			225321-3			*			*			*		
间隔跨接桥Staggered Jumper		*			225311(L=60mm) 225312(L=110mm) 225313(L=250mm)			*			*			*		
导线跨接桥Wire Jumper		订货号Order NO.			订货号Order NO.			订货号Order NO.			订货号Order NO.			订货号Order NO.		
安全警告标记 Protective Warning Marker		215701			225701			204701			206701			210701		
5位PCS		215801			225801			225801			225801			225801		
正面标记和侧面标记 Front And Side Marker		订货号Order NO.			订货号Order NO.			订货号Order NO.			订货号Order NO.			订货号Order NO.		
100PCS一片 (可提供印字服务 Printing Service)		215801			225801			225801			225801			225801		

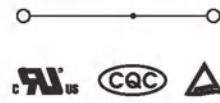
16mm² 一进一出接线端子
1-1 Feed Through Terminal Block

尺寸Size		厚度Thickness	宽度Width	高度Height
注: 安装NS35/7.5导轨后的高度 Note: Height With DIN Rail NS 35/7.5	[mm]	12	93.8	45
额定参数Rated Parameters		IEC	UL	
额定电压Rated Voltage	[V]	800	600	
额定电流Rated Current	[A]	76	65	
接线容量Wire Range		刚性Solid	柔性Fine Stranded	带冷压头Furrule
	[mm²]	0.2-16	0.2-16	0.2-10
	[AWG]	28-6	28-6	28-6
其余参数Other Parameters				
绝缘材料/阻燃等级, 符合UL94 Insulating Material / Flame Retardant Grade, Conforming To UL94		V0		
剥线长度Strip length	[mm]	16-17		
产品Product		颜色Colour		
适配NS 35/7.5导轨 Can Be Used For DIN Rail NS 35/7.5	灰Gray	订货号Order NO.		
	橙Orange	216921		
	蓝Blue	216922		
		216923		
配套附件Accessory		订货号Order NO.		
端板Cover Plate		订货号Order NO.		
	灰Gray	216121		
端板Cover Plate	橙Orange	216122		
	*	*		
跨接件Jumper	颜色Colour	订货号Order NO.		
	灰Gray	216301		
相邻跨接桥Adjacent Jumper		*		
间隔跨接桥Staggered Jumper		*		
导线跨接桥Wire Jumper		*		
安全警告标记 Protective Warning Marker		订货号Order NO.		
5位PCS		216701		
正面标记和侧面标记Front And Side Marker		订货号Order NO.		
100PCS一片 (可提供印字服务Printing Service)		225801		

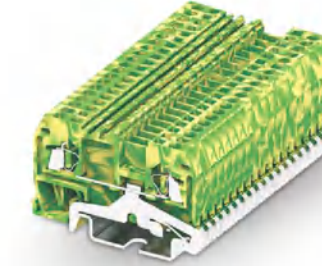
1.5mm² 一进一出接地端子
1-1 Feed Through Ground Terminal Block

尺寸Size		厚度Thickness	宽度Width	高度Height
注: 安装NS35/7.5导轨后的高度 Note: Height With DIN Rail NS 35/7.5	[mm]	4	51.6	34.5
额定参数Rated Parameters		IEC	UL	
额定电压Rated Voltage	[V]	*	*	
额定电流Rated Current	[A]	*	*	
接线容量Wire Range		刚性Solid	柔性Fine Stranded	带冷压头Furrule
	[mm²]	0.2-1.5	0.2-1.5	0.2-1
	[AWG]	28-16	28-16	28-16
其余参数Other Parameters				
绝缘材料/阻燃等级, 符合UL94 Insulating Material / Flame Retardant Grade, Conforming To UL94		V0		
剥线长度Strip length	[mm]	8-9		
产品Product		颜色Colour		
适配NS 35/7.5导轨 Can Be Used For DIN Rail NS 35/7.5	黄绿Yellow green	订货号Order NO.		
	*	215927		
	*	*		
		*		
配套附件Accessory		订货号Order NO.		
端板Cover Plate		订货号Order NO.		
	灰Gray	215121		
端板Cover Plate	橙Orange	215122		
	*	*		
跨接件Jumper	颜色Colour	订货号Order NO.		
	灰Gray	215701		
相邻跨接桥Adjacent Jumper		*		
间隔跨接桥Staggered Jumper		*		
导线跨接桥Wire Jumper		*		
安全警告标记 Protective Warning Marker		订货号Order NO.		
5位PCS		215701		
正面标记和侧面标记Front And Side Marker		订货号Order NO.		
100PCS一片 (可提供印字服务Printing Service)		215801		

2.5mm² 一进一出接地端子
1-1 Feed Through Ground Terminal Block

尺寸Size		厚度Thickness	宽度Width	高度Height
注: 安装NS35/7.5导轨后的高度 Note: Height With DIN Rail NS 35/7.5	[mm]	5	52.8	35.3
额定参数Rated Parameters		IEC	UL	
额定电压Rated Voltage	[V]	*	*	
额定电流Rated Current	[A]	*	*	
接线容量Wire Range		刚性Solid	柔性Fine Stranded	带冷压头Furrule
	[mm²]	0.2-2.5	0.2-2.5	0.2-1.5
	[AWG]	28-14	28-14	28-14
其余参数Other Parameters				
绝缘材料/阻燃等级, 符合UL94 Insulating Material / Flame Retardant Grade, Conforming To UL94		V0		
剥线长度Strip length	[mm]	8-9		
产品Product		颜色Colour		
适配NS 35/7.5导轨 Can Be Used For DIN Rail NS 35/7.5	灰Gray	订货号Order NO.		
	橙Orange	225927		
	蓝Blue	*		
		*		
配套附件Accessory		订货号Order NO.		
端板Cover Plate		订货号Order NO.		
	灰Gray	225121		
端板Cover Plate	橙Orange	225122		
	*	*		
跨接件Jumper	颜色Colour	订货号Order NO.		
	灰Gray	225701		
相邻跨接桥Adjacent Jumper		*		
间隔跨接桥Staggered Jumper		*		
导线跨接桥Wire Jumper		*		
安全警告标记 Protective Warning Marker		订货号Order NO.		
5位PCS		225701		
正面标记和侧面标记Front And Side Marker		订货号Order NO.		
100PCS一片 (可提供印字服务Printing Service)		225801		

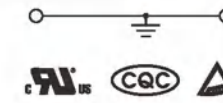
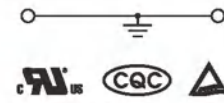
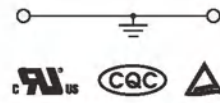
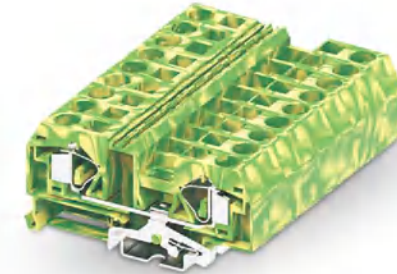
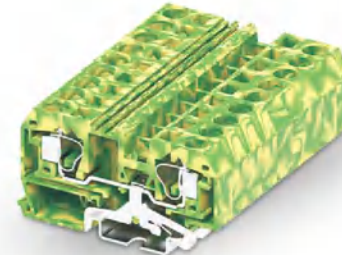
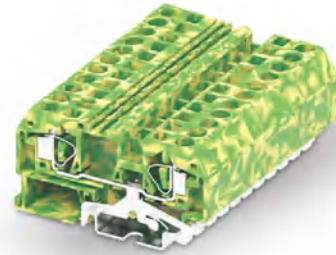

4mm² 一进一出接地端子
1-1 Feed Through Ground Terminal Block

6mm² 一进一出接地端子
1-1 Feed Through Ground Terminal Block

10mm² 一进一出接地端子
1-1 Feed Through Ground Terminal Block

16mm² 一进一出接地端子
1-1 Feed Through Ground Terminal Block

尺寸Size	
注: 安装NS35/7.5导轨后的高度 Note: Height With DIN Rail NS 35/7.5	[mm]
额定参数Rated Parameters	
额定电压Rated Voltage	[V]
额定电流Rated Current	[A]
接线容量Wire Range	
	[mm ²]
	[AWG]
其余参数Other Parameters	
绝缘材料/阻燃等级, 符合UL94 Insulating Material / Flame Retardant Grade, Conforming To UL94	
剥线长度Strip length	[mm]

技术参数Technical Parameter		
厚度Thickness	宽度Width	高度Height
6	59	36
IEC	UL	
*	*	
*	*	
刚性Solid	柔性Fine Stranded	带冷压头Furrule
0.2-4	0.2-4	0.2-2.5
28-12	28-12	28-12
V0		
9-10		

技术参数Technical Parameter		
厚度Thickness	宽度Width	高度Height
8	73.6	40
IEC	UL	
*	*	
*	*	
刚性Solid	柔性Fine Stranded	带冷压头Furrule
0.2-6	0.2-6	0.2-4
28-10	28-10	28-10
V0		
12-13		

技术参数Technical Parameter		
厚度Thickness	宽度Width	高度Height
10	76.7	42.5
IEC	UL	
*	*	
*	*	
刚性Solid	柔性Fine Stranded	带冷压头Furrule
0.2-10	0.2-10	0.2-6
28-8	28-8	28-8
V0		
12-13		

技术参数Technical Parameter		
厚度Thickness	宽度Width	高度Height
12	93.8	45
IEC	UL	
*	*	
*	*	
刚性Solid	柔性Fine Stranded	带冷压头Furrule
0.2-16	0.2-16	0.2-10
28-6	28-6	28-6
V0		
16-17		

产品信息Product	
颜色Colour	黄绿Yellow green
适配NS 35/7.5导轨 Can Be Used For DIN Rail NS 35/7.5	*

订货信息Order Information	
订货号Order NO.	204927
	*
	*

订货信息Order Information	
订货号Order NO.	206927
	*
	*

订货信息Order Information	
订货号Order NO.	210927
	*
	*

订货信息Order Information	
订货号Order NO.	216927
	*
	*

盖板Cover Plate	
颜色Colour	灰Gray
	橙Orange
	*

配套附件Accessory	
订货号Order NO.	204121
	204122
	*

配套附件Accessory	
订货号Order NO.	206121
	206122
	*

配套附件Accessory	
订货号Order NO.	210121
	210122
	*

配套附件Accessory	
订货号Order NO.	216121
	216122
	*

跨接件Jumper	
颜色Colour	灰Gray
相邻跨接桥Adjacent Jumper	*
间隔跨接桥Staggered Jumper	*
导线跨接桥Wire Jumper	*

订货信息Order Information	
订货号Order NO.	
	*
	*
	*

订货信息Order Information	
订货号Order NO.	
	*
	*
	*

订货信息Order Information	
订货号Order NO.	
	*
	*
	*

订货信息Order Information	
订货号Order NO.	
	*
	*
	*

安全警告标记 Protective Warning Marker	
5位PCS	
正面标记和侧面标记Front And Side Marker	
100PCS一片 (可提供印字服务Printing Service)	

订货信息Order Information	
订货号Order NO.	204701
	225801

订货信息Order Information	
订货号Order NO.	206701
	225801

订货信息Order Information	
订货号Order NO.	210701
	225801

订货信息Order Information	
订货号Order NO.	216701
	225801

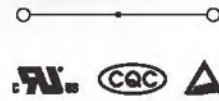

6mm² 一进一出接线端子 (侧面标记)
1-1 Feed Through Terminal Block (Side Marking)

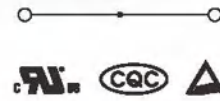
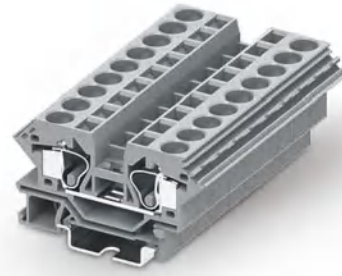

10mm² 一进一出接线端子 (侧面标记)
1-1 Feed Through Terminal Block (Side Marking)



16mm² 一进一出接线端子 (侧面标记)
1-1 Feed Through Terminal Block (Side Marking)

尺寸Size	
注: 安装NS35/7.5导轨后的高度 Note: Height With DIN Rail NS 35/7.5	[mm]
额定参数Rated Parameters	
额定电压Rated Voltage	[V]
额定电流Rated Current	[A]
接线容量Wire Range	
	[mm ²]
	[AWG]
其余参数Other Parameters	
绝缘材料/阻燃等级, 符合UL94 Insulating Material / Flame Retardant Grade, Conforming To UL94	
剥线长度Strip length	[mm]
产品Product	颜色Colour
适配NS 35/7.5导轨 Can Be Used For DIN Rail NS 35/7.5	灰Gray
	橙Orange
	蓝Blue
端板Cover Plate	
	灰Gray
	橙Orange
跨接件Jumper	颜色Colour
	灰Gray
相邻跨接桥Adjacent Jumper	
间隔跨接桥Staggered Jumper	
导线跨接桥Wire Jumper	
安全警告标记Protective Warning Marker	
5位PCS	
正面标记和侧面标记Front And Side Marker	
100PCS一片 (可提供印字服务Printing Service)	

技术参数Technical Parameter		
厚度Thickness	宽度Width	高度Height
8	62	38.5
IEC	UL	
800	600	
41	30	
刚性Solid	柔性Fine Stranded	带冷压头Furrule
0.2-6	0.2-6	0.2-4
28-10	28-10	28-10
V0		
12-13		

订货信息Order Information	
订货号Order NO.	206911
	206912
	206913

配套附件Accessory	
订货号Order NO.	206111
	206112
	*

订货号Order NO.	206301
	*
	*

订货号Order NO.	206701
	225801

技术参数Technical Parameter		
厚度Thickness	宽度Width	高度Height
10	69.5	41
IEC	UL	
800	600	
57	50	
刚性Solid	柔性Fine Stranded	带冷压头Furrule
0.2-10	0.2-10	0.2-6
28-8	28-8	28-8
V0		
12-13		

订货信息Order Information	
订货号Order NO.	210911
	210912
	210913

配套附件Accessory	
订货号Order NO.	210111
	210112
	*

订货号Order NO.	210301
	*
	*

订货号Order NO.	210701
	225801

技术参数Technical Parameter		
厚度Thickness	宽度Width	高度Height
12	80	45
IEC	UL	
800	600	
76	65	
刚性Solid	柔性Fine Stranded	带冷压头Furrule
0.2-16	0.2-16	0.2-10
28-6	28-6	28-6
V0		
16-17		

订货信息Order Information	
订货号Order NO.	216911
	216912
	216913

配套附件Accessory	
订货号Order NO.	216111
	216122
	*

订货号Order NO.	216301
	*
	*

订货号Order NO.	216701
	225801

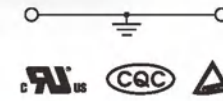
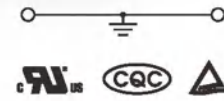
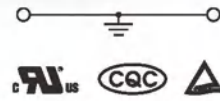
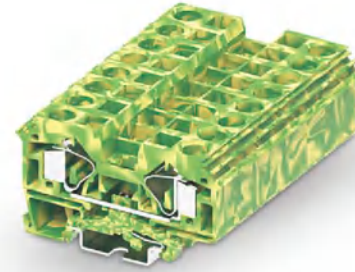
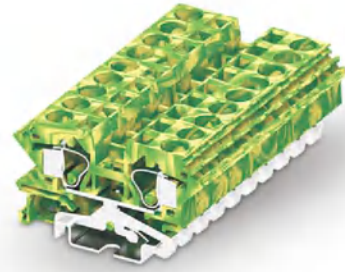
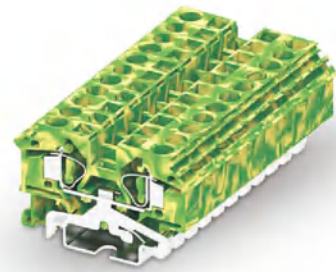

6mm² 一进一出接地端子 (侧面标记)
1-1 Feed Through Ground Terminal Block (Side Marking)

10mm² 一进一出接地端子 (侧面标记)
1-1 Feed Through Ground Terminal Block (Side Marking)

16mm² 一进一出接地端子 (侧面标记)
1-1 Feed Through Ground Terminal Block (Side Marking)

尺寸Size	
注: 安装NS35/7.5导轨后的高度 Note: Height With DIN Rail NS 35/7.5	[mm]
额定参数Rated Parameters	
额定电压Rated Voltage	[V]
额定电流Rated Current	[A]
接线容量Wire Range	
	[mm ²]
	[AWG]
其余参数Other Parameters	
绝缘材料/阻燃等级, 符合UL94 Insulating Material / Flame Retardant Grade, Conforming To UL94	
剥线长度Strip length	[mm]
产品Product	
颜色Colour	黄绿Yellow green
适配NS 35/7.5导轨 Can Be Used For DIN Rail NS 35/7.5	*
端板Cover Plate	
	灰Gray
	橙Orange
跨接件Jumper	
	灰Gray
相邻跨接桥Adjacent Jumper	
间隔跨接桥Staggered Jumper	
导线跨接桥Wire Jumper	
安全警告标记 Protective Warning Marker	
5位PCS	
正面标记和侧面标记Front And Side Marker	
100PCS一片 (可提供印字服务Printing Service)	

技术参数Technical Parameter		
厚度Thickness	宽度Width	高度Height
8	62	38.5
IEC	UL	
*	*	
额定电压Rated Voltage	额定电流Rated Current	
*	*	
接线容量Wire Range		
刚性Solid	柔性Fine Stranded	带冷压头Furrule
0.2-6	0.2-6	0.2-4
28-10	28-10	28-10
其余参数Other Parameters		
绝缘材料/阻燃等级, 符合UL94 Insulating Material / Flame Retardant Grade, Conforming To UL94	V0	
剥线长度Strip length	12-13	

技术参数Technical Parameter		
厚度Thickness	宽度Width	高度Height
10	69.5	41
IEC	UL	
*	*	
额定电压Rated Voltage	额定电流Rated Current	
*	*	
接线容量Wire Range		
刚性Solid	柔性Fine Stranded	带冷压头Furrule
0.2-10	0.2-10	0.2-6
28-8	28-8	28-8
其余参数Other Parameters		
绝缘材料/阻燃等级, 符合UL94 Insulating Material / Flame Retardant Grade, Conforming To UL94	V0	
剥线长度Strip length	12-13	

技术参数Technical Parameter		
厚度Thickness	宽度Width	高度Height
12	80	45
IEC	UL	
*	*	
额定电压Rated Voltage	额定电流Rated Current	
*	*	
接线容量Wire Range		
刚性Solid	柔性Fine Stranded	带冷压头Furrule
0.2-16	0.2-16	0.2-10
28-6	28-6	28-6
其余参数Other Parameters		
绝缘材料/阻燃等级, 符合UL94 Insulating Material / Flame Retardant Grade, Conforming To UL94	V0	
剥线长度Strip length	16-17	

订货信息Order Information	
订货号Order NO.	206917
颜色Colour	黄绿Yellow green
适配NS 35/7.5导轨 Can Be Used For DIN Rail NS 35/7.5	*
配套附件Accessory	
端板Cover Plate	灰Gray
端板Cover Plate	橙Orange
跨接件Jumper	
跨接件Jumper	灰Gray
相邻跨接桥Adjacent Jumper	*
间隔跨接桥Staggered Jumper	*
导线跨接桥Wire Jumper	*
安全警告标记 Protective Warning Marker	
安全警告标记 Protective Warning Marker	5位PCS
正面标记和侧面标记Front And Side Marker	
正面标记和侧面标记Front And Side Marker	100PCS一片 (可提供印字服务Printing Service)

订货信息Order Information	
订货号Order NO.	210917
颜色Colour	黄绿Yellow green
适配NS 35/7.5导轨 Can Be Used For DIN Rail NS 35/7.5	*
配套附件Accessory	
端板Cover Plate	灰Gray
端板Cover Plate	橙Orange
跨接件Jumper	
跨接件Jumper	灰Gray
相邻跨接桥Adjacent Jumper	*
间隔跨接桥Staggered Jumper	*
导线跨接桥Wire Jumper	*
安全警告标记 Protective Warning Marker	
安全警告标记 Protective Warning Marker	5位PCS
正面标记和侧面标记Front And Side Marker	
正面标记和侧面标记Front And Side Marker	100PCS一片 (可提供印字服务Printing Service)

订货信息Order Information	
订货号Order NO.	216917
颜色Colour	黄绿Yellow green
适配NS 35/7.5导轨 Can Be Used For DIN Rail NS 35/7.5	*
配套附件Accessory	
端板Cover Plate	灰Gray
端板Cover Plate	橙Orange
跨接件Jumper	
跨接件Jumper	灰Gray
相邻跨接桥Adjacent Jumper	*
间隔跨接桥Staggered Jumper	*
导线跨接桥Wire Jumper	*
安全警告标记 Protective Warning Marker	
安全警告标记 Protective Warning Marker	5位PCS
正面标记和侧面标记Front And Side Marker	
正面标记和侧面标记Front And Side Marker	100PCS一片 (可提供印字服务Printing Service)

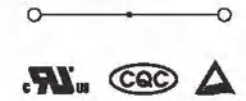
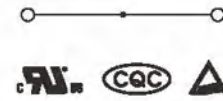
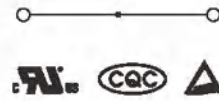
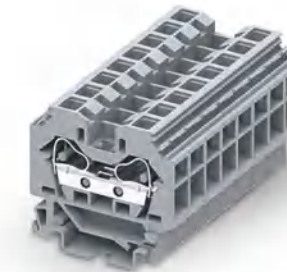
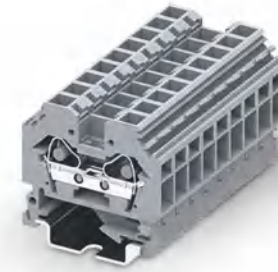
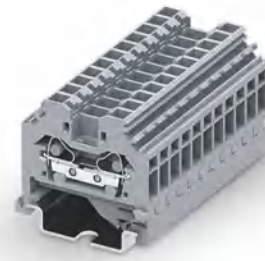

2.5mm² 一进一出侧面接线端子
1-1 Feed Through Terminal Block of Side-entry

4mm² 一进一出侧面接线端子
1-1 Feed Through Terminal Block of Side-entry

6mm² 一进一出侧面接线端子
1-1 Feed Through Terminal Block of Side-entry

10mm² 一进一出侧面接线端子
1-1 Feed Through Terminal Block of Side-entry

16mm² 一进一出侧面接线端子
1-1 Feed Through Terminal Block of Side-entry

尺寸Size	
注: 安装NS35/7.5导轨后的高度 Note: Height With DIN Rail NS 35/7.5	[mm]
额定参数Rated Parameters	
额定电压Rated Voltage	[V]
额定电流Rated Current	[A]
接线容量Wire Range	
	[mm²]
	[AWG]
其余参数Other Parameters	
绝缘材料/阻燃等级, 符合UL94 Insulating Material / Flame Retardant Grade, Conforming To UL94	
剥线长度Strip length	[mm]
产品Product	颜色Colour
适配NS 35/7.5导轨 Can Be Used For DIN Rail NS 35/7.5	灰Gray
	橙Orange
	蓝Blue
端板Cover Plate	
	灰Gray
端板Cover Plate	橙Orange
	*
跨接件Jumper	颜色Colour
	灰Gray
相邻跨接桥Adjacent Jumper	
间隔跨接桥Staggered Jumper	
导线跨接桥Wire Jumper	
安全警告标记 Protective Warning Marker	
5位PCS	
正面标记和侧面标记Front And Side Marker	
100PCS一片 (可提供印字服务Printing Service)	

技术参数Technical Parameter		
厚度Thickness	宽度Width	高度Height
5	38.4	38
IEC	UL	
800	600	
24	20	
刚性Solid	柔性Fine Stranded	带冷压头Furrule
0.2-2.5	0.2-2.5	0.2-1.5
28-14	28-14	28-14

技术参数Technical Parameter		
厚度Thickness	宽度Width	高度Height
6	40.2	40
IEC	UL	
800	600	
32	20	
刚性Solid	柔性Fine Stranded	带冷压头Furrule
0.2-4	0.2-4	0.2-2.5
28-12	28-12	28-12

技术参数Technical Parameter		
厚度Thickness	宽度Width	高度Height
8	46	44.5
IEC	UL	
800	600	
41	30	
刚性Solid	柔性Fine Stranded	带冷压头Furrule
0.2-6	0.2-6	0.2-4
28-10	28-10	28-10

技术参数Technical Parameter		
厚度Thickness	宽度Width	高度Height
10	52.2	49
IEC	UL	
800	600	
57	50	
刚性Solid	柔性Fine Stranded	带冷压头Furrule
0.2-10	0.2-10	0.2-6
28-8	28-8	28-8

技术参数Technical Parameter		
厚度Thickness	宽度Width	高度Height
12	58.4	53
IEC	UL	
800	600	
76	65	
刚性Solid	柔性Fine Stranded	带冷压头Furrule
0.2-16	0.2-16	0.2-10
28-6	28-6	28-6

订货信息Order Information	
订货号Order NO.	225915
	*
	225916

订货信息Order Information	
订货号Order NO.	204901
	*
	204902

订货信息Order Information	
订货号Order NO.	206901
	*
	206902

订货信息Order Information	
订货号Order NO.	210901
	*
	210902

订货信息Order Information	
订货号Order NO.	216901
	*
	216902

配套附件Accessory	
订货号Order NO.	225111
	225112
	*

配套附件Accessory	
订货号Order NO.	204101
	204102
	*

配套附件Accessory	
订货号Order NO.	206101
	206102
	*

配套附件Accessory	
订货号Order NO.	210101
	210102
	*

配套附件Accessory	
订货号Order NO.	216101
	216102
	*

跨接件Jumper	
订货号Order NO.	225301
	*
	*

跨接件Jumper	
订货号Order NO.	204301
	*
	*

跨接件Jumper	
订货号Order NO.	206301
	*
	*

跨接件Jumper	
订货号Order NO.	210301
	*
	*

跨接件Jumper	
订货号Order NO.	216301
	*
	*

安全警告标记 Protective Warning Marker	
订货号Order NO.	225701
	225801

安全警告标记 Protective Warning Marker	
订货号Order NO.	204701
	225801

安全警告标记 Protective Warning Marker	
订货号Order NO.	206701
	225801

安全警告标记 Protective Warning Marker	
订货号Order NO.	210701
	225801

安全警告标记 Protective Warning Marker	
订货号Order NO.	216701
	225801

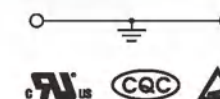
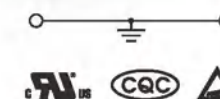
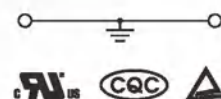
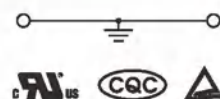
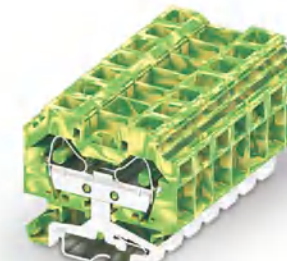
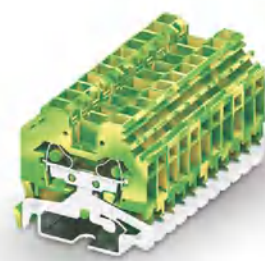
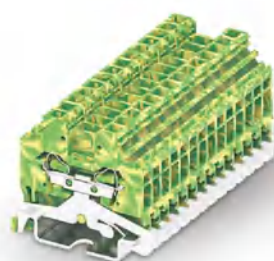

2.5mm² 一进一出侧面接地端子
1-1 Feed Through Ground Terminal Block of Side-entry

4mm² 一进一出侧面接地端子
1-1 Feed Through Ground Terminal Block of Side-entry

6mm² 一进一出侧面接地端子
1-1 Feed Through Ground Terminal Block of Side-entry

10mm² 一进一出侧面接地端子
1-1 Feed Through Ground Terminal Block of Side-entry

16mm² 一进一出侧面接地端子
1-1 Feed Through Ground Terminal Block of Side-entry

		技术参数Technical Parameter			技术参数Technical Parameter			技术参数Technical Parameter			技术参数Technical Parameter			技术参数Technical Parameter						
尺寸Size		厚度Thickness	宽度Width	高度Height	厚度Thickness	宽度Width	高度Height	厚度Thickness	宽度Width	高度Height	厚度Thickness	宽度Width	高度Height	厚度Thickness	宽度Width	高度Height				
注: 安装NS35/7.5导轨后的高度 Note: Height With DIN Rail NS 35/7.5		[mm]	5	38.4	38	6	40.2	40	8	46	44.5	10	52.2	49	12	58.4	53			
额定参数Rated Parameters		IEC	UL		IEC	UL		IEC	UL		IEC	UL		IEC	UL		IEC	UL		
额定电压Rated Voltage		[V]	*	*	*	*	*	*	*	*	*	*	*	*	*	*	*	*		
额定电流Rated Current		[A]	*	*	*	*	*	*	*	*	*	*	*	*	*	*	*	*		
接线容量Wire Range		[mm ²]	刚性Solid	柔性Fine Stranded	带冷压头Furrule	刚性Solid	柔性Fine Stranded	带冷压头Furrule	刚性Solid	柔性Fine Stranded	带冷压头Furrule	刚性Solid	柔性Fine Stranded	带冷压头Furrule	刚性Solid	柔性Fine Stranded	带冷压头Furrule	刚性Solid	柔性Fine Stranded	带冷压头Furrule
		[AWG]	0.2-2.5	0.2-2.5	0.2-1.5	0.2-4	0.2-4	0.2-2.5	0.2-6	0.2-6	0.2-4	0.2-10	0.2-10	0.2-6	0.2-16	0.2-16	0.2-10	0.2-16	0.2-16	0.2-10
			28-14	28-14	28-14	28-12	28-12	28-12	28-10	28-10	28-10	28-8	28-8	28-8	28-6	28-6	28-6	28-6	28-6	28-6
其余参数Other Parameters																				
绝缘材料/阻燃等级, 符合UL94 Insulating Material / Flame Retardant Grade, Conforming To UL94			V0			V0			V0			V0			V0					
剥线长度Strip length		[mm]	8-9			9-10			12-13			12-13			16-17					
产品Product		颜色Colour	订货信息Order Information			订货信息Order Information			订货信息Order Information			订货信息Order Information			订货信息Order Information					
适配NS 35/7.5导轨 Can Be Used For DIN Rail NS 35/7.5		黄绿Yellow green	订货号Order NO.			订货号Order NO.			订货号Order NO.			订货号Order NO.			订货号Order NO.					
		*	225917			204907			206907			210907			216907					
		*	*			*			*			*			*					
		*	*			*			*			*			*					
端板Cover Plate		灰Gray	订货号Order NO.			订货号Order NO.			订货号Order NO.			订货号Order NO.			订货号Order NO.					
		橙Orange	225111			204101			206101			210101			216101					
		*	225112			204102			206102			210102			216102					
		*	*			*			*			*			*					
跨接件Jumper		颜色Colour	订货号Order NO.			订货号Order NO.			订货号Order NO.			订货号Order NO.			订货号Order NO.					
		灰Gray	订货号Order NO.			订货号Order NO.			订货号Order NO.			订货号Order NO.			订货号Order NO.					
相邻跨接桥Adjacent Jumper			*			*			*			*			*					
间隔跨接桥Staggered Jumper			*			*			*			*			*					
导线跨接桥Wire Jumper			*			*			*			*			*					
安全警告标记 Protective Warning Marker			订货号Order NO.			订货号Order NO.			订货号Order NO.			订货号Order NO.			订货号Order NO.					
5位PCS			225701			204701			206701			210701			216701					
正面标记和侧面标记Front And Side Marker			订货号Order NO.			订货号Order NO.			订货号Order NO.			订货号Order NO.			订货号Order NO.					
100PCS一片 (可提供印字服务Printing Service)			225801			225801			225801			225801			225801					

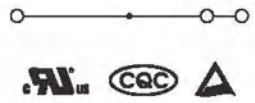
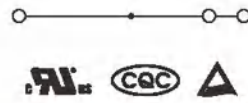
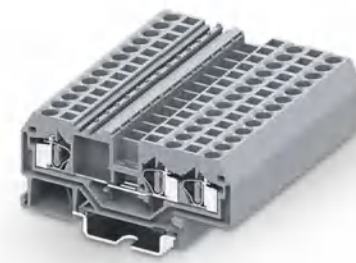
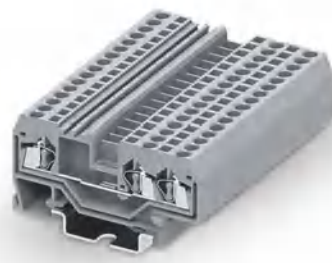
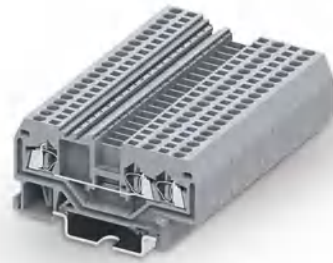
1.5mm² 一进两出接线端子
1-2 Feed Through Terminal Block2.5mm² 一进两出接线端子
1-2 Feed Through Terminal Block4mm² 一进两出接线端子
1-2 Feed Through Terminal Block6mm² 一进两出接线端子
1-2 Feed Through Terminal Block10mm² 一进两出接线端子
1-2 Feed Through Terminal Block

尺寸Size	技术参数Technical Parameter			技术参数Technical Parameter			技术参数Technical Parameter			技术参数Technical Parameter			技术参数Technical Parameter			
	厚度Thickness	宽度Width	高度Height	厚度Thickness	宽度Width	高度Height	厚度Thickness	宽度Width	高度Height	厚度Thickness	宽度Width	高度Height	厚度Thickness	宽度Width	高度Height	
注: 安装NS35/7.5导轨后的高度 Note: Height With DIN Rail NS 35/7.5	[mm]	4	62.1	34.5	5	64.4	35.5	6	72.6	36	8	92.2	40	10	96.6	42.5
额定参数Rated Parameters		IEC	UL		IEC	UL		IEC	UL		IEC	UL		IEC	UL	
额定电压Rated Voltage	[V]	800	600		800	600		800	600		800	600		800	600	
额定电流Rated Current	[A]	18	10		24	20		32	20		41	30		57	50	
接线容量Wire Range		刚性Solid	柔性Fine Stranded	带冷压头Furrule	刚性Solid	柔性Fine Stranded	带冷压头Furrule	刚性Solid	柔性Fine Stranded	带冷压头Furrule	刚性Solid	柔性Fine Stranded	带冷压头Furrule	刚性Solid	柔性Fine Stranded	带冷压头Furrule
	[mm ²]	0.2-1.5	0.2-1.5	0.2-1	0.2-2.5	0.2-2.5	0.2-1.5	0.2-4	0.2-4	0.2-2.5	0.2-6	0.2-6	0.2-4	0.2-10	0.2-10	0.2-6
	[AWG]	28-16	28-16	28-16	28-14	28-14	28-14	28-12	28-12	28-12	28-10	28-10	28-10	28-8	28-8	28-8
其余参数Other Parameters		绝缘材料/阻燃等级, 符合UL94 Insulating Material / Flame Retardant Grade, Conforming To UL94			V0			V0			V0			V0		
剥线长度Strip length	[mm]	8-9			8-9			9-10			12-13			12-13		
产品Product	颜色Colour	订货信息Order Information			订货信息Order Information			订货信息Order Information			订货信息Order Information			订货信息Order Information		
适配NS 35/7.5导轨 Can Be Used For DIN Rail NS 35/7.5	灰Gray 橙Orange 蓝Blue	订货号Order NO.	215951		订货号Order NO.	225951		订货号Order NO.	204951		订货号Order NO.	206951		订货号Order NO.	210951	
		订货号Order NO.	215952		订货号Order NO.	225952		订货号Order NO.	204952		订货号Order NO.	206952		订货号Order NO.	210952	
		订货号Order NO.	215954		订货号Order NO.	225954		订货号Order NO.	204954		订货号Order NO.	206953		订货号Order NO.	210953	
端板Cover Plate	灰Gray 橙Orange	配套附件Accessory			配套附件Accessory			配套附件Accessory			配套附件Accessory			配套附件Accessory		
		订货号Order NO.	215151		订货号Order NO.	225151		订货号Order NO.	204151		订货号Order NO.	206151		订货号Order NO.	210151	
		订货号Order NO.	215152		订货号Order NO.	225152		订货号Order NO.	204152		订货号Order NO.	206152		订货号Order NO.	210152	
跨接件Jumper	灰Gray	订货号Order NO.			订货号Order NO.			订货号Order NO.			订货号Order NO.			订货号Order NO.		
相邻跨接桥Adjacent Jumper		215301			225301			204301			206301			210301		
间隔跨接桥Staggered Jumper		*			225321-3			*			*			*		
导线跨接桥Wire Jumper		*			225311(L=60mm) 225312(L=110mm) 225313(L=250mm)			*			*			*		
安全警告标记 Protective Warning Marker		订货号Order NO.			订货号Order NO.			订货号Order NO.			订货号Order NO.			订货号Order NO.		
5位PCS		215701			225701			204701			206701			210701		
正面标记和侧面标记Front And Side Marker		订货号Order NO.			订货号Order NO.			订货号Order NO.			订货号Order NO.			订货号Order NO.		
100PCS一片 (可提供印字服务Printing Service)		215801			225801			225801			225801			225801		



16mm² 一进两出接线端子
1-2 Feed Through Terminal Block

尺寸Size		厚度Thickness	宽度Width	高度Height
注: 安装NS35/7.5导轨后的高度 Note: Height With DIN Rail NS 35/7.5		12	103.5	45
额定参数Rated Parameters		IEC	UL	
额定电压Rated Voltage	[V]	800	600	
额定电流Rated Current	[A]	76	65	
接线容量Wire Range		刚性Solid	柔性Fine Stranded	带冷压头Furrule
	[mm²]	0.2-16	0.2-16	0.2-10
	[AWG]	28-6	28-6	28-6
其余参数Other Parameters				
绝缘材料/阻燃等级, 符合UL94 Insulating Material / Flame Retardant Grade, Conforming To UL94		V0		
剥线长度Strip length	[mm]	16-17		
产品Product		颜色Colour		
适配NS 35/7.5导轨 Can Be Used For DIN Rail NS 35/7.5	灰Gray	订货号Order NO.		
	橙Orange	216951		
	蓝Blue	216952		
		216953		
配套附件Accessory		订货号Order NO.		
端板Cover Plate		216151		
端板Cover Plate	灰Gray	216152		
	橙Orange	*		
跨接件Jumper		颜色Colour		
	灰Gray	订货号Order NO.		
相邻跨接桥Adjacent Jumper		*		
间隔跨接桥Staggered Jumper		*		
导线跨接桥Wire Jumper		*		
安全警告标记 Protective Warning Marker		订货号Order NO.		
5位PCS		216701		
正面标记和侧面标记Front And Side Marker		订货号Order NO.		
100PCS一片 (可提供印字服务Printing Service)		225801		

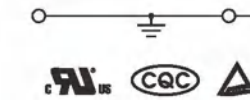
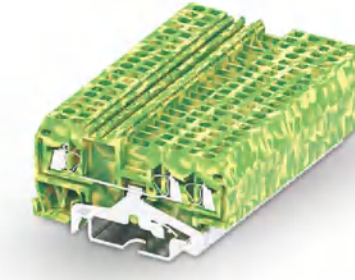

1.5mm² 一进两出接地端子
1-2 Feed Through Ground Terminal Block

尺寸Size		厚度Thickness	宽度Width	高度Height
注: 安装NS35/7.5导轨后的高度 Note: Height With DIN Rail NS 35/7.5		4	62.1	34.5
额定参数Rated Parameters		IEC	UL	
额定电压Rated Voltage	[V]	*	*	
额定电流Rated Current	[A]	*	*	
接线容量Wire Range		刚性Solid	柔性Fine Stranded	带冷压头Furrule
	[mm²]	0.2-1.5	0.2-1.5	0.2-1
	[AWG]	28-16	28-16	28-16
其余参数Other Parameters				
绝缘材料/阻燃等级, 符合UL94 Insulating Material / Flame Retardant Grade, Conforming To UL94		V0		
剥线长度Strip length	[mm]	8-9		
产品Product		颜色Colour		
适配NS 35/7.5导轨 Can Be Used For DIN Rail NS 35/7.5	黄绿Yellow green	订货号Order NO.		
	*	215957		
	*	*		
		*		
配套附件Accessory		订货号Order NO.		
端板Cover Plate		215151		
端板Cover Plate	灰Gray	215152		
	橙Orange	*		
跨接件Jumper		颜色Colour		
	灰Gray	订货号Order NO.		
相邻跨接桥Adjacent Jumper		*		
间隔跨接桥Staggered Jumper		*		
导线跨接桥Wire Jumper		*		
安全警告标记 Protective Warning Marker		订货号Order NO.		
5位PCS		215701		
正面标记和侧面标记Front And Side Marker		订货号Order NO.		
100PCS一片 (可提供印字服务Printing Service)		215801		

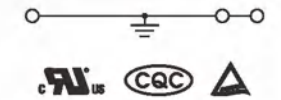
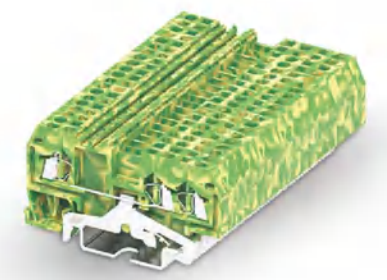

2.5mm² 一进两出接地端子
1-2 Feed Through Ground Terminal Block

尺寸Size		厚度Thickness	宽度Width	高度Height
注: 安装NS35/7.5导轨后的高度 Note: Height With DIN Rail NS 35/7.5		5	64.4	35.5
额定参数Rated Parameters		IEC	UL	
额定电压Rated Voltage	[V]	*	*	
额定电流Rated Current	[A]	*	*	
接线容量Wire Range		刚性Solid	柔性Fine Stranded	带冷压头Furrule
	[mm²]	0.2-2.5	0.2-2.5	0.2-1.5
	[AWG]	28-14	28-14	28-14
其余参数Other Parameters				
绝缘材料/阻燃等级, 符合UL94 Insulating Material / Flame Retardant Grade, Conforming To UL94		V0		
剥线长度Strip length	[mm]	8-9		
产品Product		颜色Colour		
适配NS 35/7.5导轨 Can Be Used For DIN Rail NS 35/7.5	黄绿Yellow green	订货号Order NO.		
	*	225957		
	*	*		
		*		
配套附件Accessory		订货号Order NO.		
端板Cover Plate		225151		
端板Cover Plate	灰Gray	225152		
	橙Orange	*		
跨接件Jumper		颜色Colour		
	灰Gray	订货号Order NO.		
相邻跨接桥Adjacent Jumper		*		
间隔跨接桥Staggered Jumper		*		
导线跨接桥Wire Jumper		*		
安全警告标记 Protective Warning Marker		订货号Order NO.		
5位PCS		225701		
正面标记和侧面标记Front And Side Marker		订货号Order NO.		
100PCS一片 (可提供印字服务Printing Service)		225801		

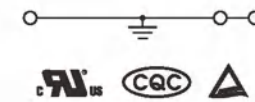
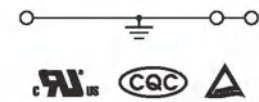
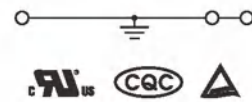
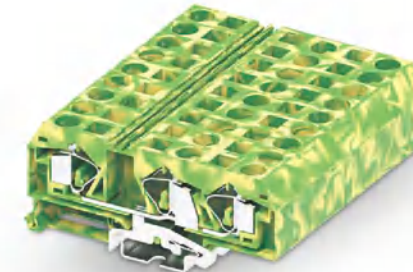
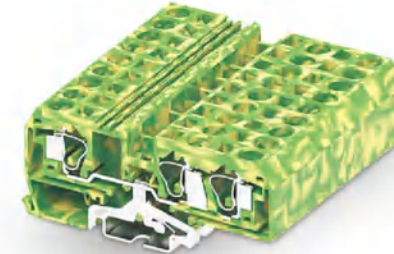
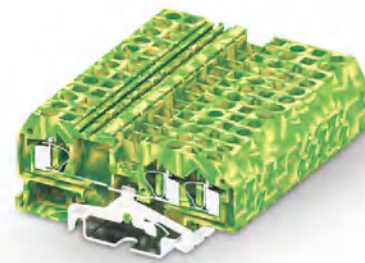

4mm² 一进两出接地端子
1-2 Feed Through Ground Terminal Block

6mm² 一进两出接地端子
1-2 Feed Through Ground Terminal Block

10mm² 一进两出接地端子
1-2 Feed Through Ground Terminal Block

16mm² 一进两出接地端子
1-2 Feed Through Ground Terminal Block

尺寸Size	
注: 安装NS35/7.5导轨后的高度 Note: Height With DIN Rail NS 35/7.5	[mm]
额定参数Rated Parameters	
额定电压Rated Voltage	[V]
额定电流Rated Current	[A]
接线容量Wire Range	
	[mm ²]
	[AWG]
其余参数Other Parameters	
绝缘材料/阻燃等级, 符合UL94 Insulating Material / Flame Retardant Grade, Conforming To UL94	
剥线长度Strip length	[mm]

技术参数Technical Parameter		
厚度Thickness	宽度Width	高度Height
6	73.5	36
技术规格		
IEC	UL	
*	*	
*	*	
接线容量Wire Range		
刚性Solid	柔性Fine Stranded	带冷压头Furrule
0.2-4	0.2-4	0.2-2.5
28-12	28-12	28-12
V0		
9-10		

技术参数Technical Parameter		
厚度Thickness	宽度Width	高度Height
8	92.2	40
技术规格		
IEC	UL	
*	*	
*	*	
接线容量Wire Range		
刚性Solid	柔性Fine Stranded	带冷压头Furrule
0.2-6	0.2-6	0.2-4
28-10	28-10	28-10
V0		
12-13		

技术参数Technical Parameter		
厚度Thickness	宽度Width	高度Height
10	96.6	42.5
技术规格		
IEC	UL	
*	*	
*	*	
接线容量Wire Range		
刚性Solid	柔性Fine Stranded	带冷压头Furrule
0.2-10	0.2-10	0.2-6
28-8	28-8	28-8
V0		
12-13		

技术参数Technical Parameter		
厚度Thickness	宽度Width	高度Height
12	103.5	45
技术规格		
IEC	UL	
*	*	
*	*	
接线容量Wire Range		
刚性Solid	柔性Fine Stranded	带冷压头Furrule
0.2-16	0.2-16	0.2-10
28-6	28-6	28-6
V0		
16-17		

产品信息Product	
颜色Colour	黄绿Yellow green
适配NS 35/7.5导轨 Can Be Used For DIN Rail NS 35/7.5	*

订货信息Order Information	
订货号Order NO.	204957
*	*
*	*

订货信息Order Information	
订货号Order NO.	206957
*	*
*	*

订货信息Order Information	
订货号Order NO.	210957
*	*
*	*

订货信息Order Information	
订货号Order NO.	216957
*	*
*	*

盖板Cover Plate	
颜色Colour	灰Gray
盖板Cover Plate	橙Orange
*	*

配套附件Accessory	
订货号Order NO.	204151
	204152
*	*

配套附件Accessory	
订货号Order NO.	206151
	206152
*	*

配套附件Accessory	
订货号Order NO.	210151
	210152
*	*

配套附件Accessory	
订货号Order NO.	216151
	216152
*	*

跨接件Jumper	
颜色Colour	灰Gray
相邻跨接桥Adjacent Jumper	*
间隔跨接桥Staggered Jumper	*
导线跨接桥Wire Jumper	*

订货信息Order Information	
订货号Order NO.	
*	*
*	*
*	*

订货信息Order Information	
订货号Order NO.	
*	*
*	*
*	*

订货信息Order Information	
订货号Order NO.	
*	*
*	*
*	*

订货信息Order Information	
订货号Order NO.	
*	*
*	*
*	*

安全警告标记 Protective Warning Marker	
5位PCS	
正面标记和侧面标记Front And Side Marker	
100PCS一片 (可提供印字服务Printing Service)	

订货信息Order Information	
订货号Order NO.	204701
	225801

订货信息Order Information	
订货号Order NO.	206701
	225801

订货信息Order Information	
订货号Order NO.	210701
	225801

订货信息Order Information	
订货号Order NO.	216701
	225801

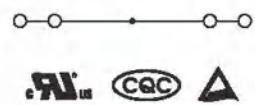
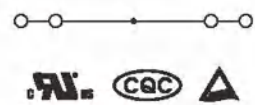
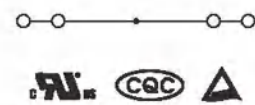
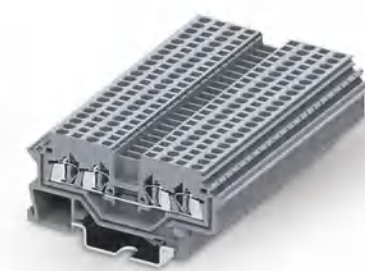
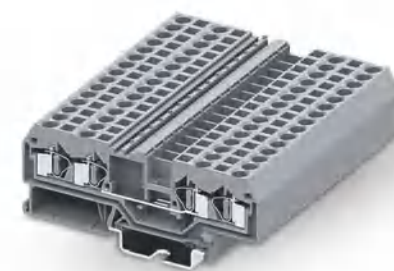
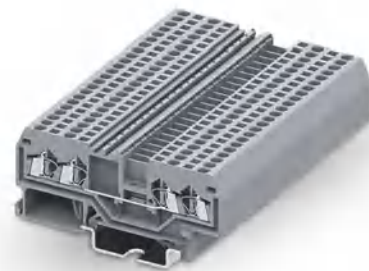
1.5mm² 两进两出接线端子
2-2 Feed Through Terminal Block2.5mm² 两进两出接线端子
2-2 Feed Through Terminal Block4mm² 两进两出接线端子
2-2 Feed Through Terminal Block1.5mm² 两进两出接线端子(侧面标记)
2-2 Feed Through Terminal Block(Side Marking)2.5mm² 两进两出接线端子(侧面标记)
2-2 Feed Through Terminal Block(Side Marking)

尺寸Size	技术参数Technical Parameter			技术参数Technical Parameter			技术参数Technical Parameter			技术参数Technical Parameter			技术参数Technical Parameter			
	厚度Thickness	宽度Width	高度Height	厚度Thickness	宽度Width	高度Height	厚度Thickness	宽度Width	高度Height	厚度Thickness	宽度Width	高度Height	厚度Thickness	宽度Width	高度Height	
注: 安装NS35/7.5导轨后的高度 Note: Height With DIN Rail NS 35/7.5	[mm]	4	72.6	34.5	5	75.9	35.5	6	86.2	36	4	68	34.5	5	73	35.5
额定参数Rated Parameters		IEC	UL		IEC	UL		IEC	UL		IEC	UL		IEC	UL	
额定电压Rated Voltage	[V]	800	600		800	600		800	600		800	600		800	600	
额定电流Rated Current	[A]	18	10		24	20		32	20		18	10		24	20	
接线容量Wire Range		刚性Solid	柔性Fine Stranded	带冷压头Furrule	刚性Solid	柔性Fine Stranded	带冷压头Furrule	刚性Solid	柔性Fine Stranded	带冷压头Furrule	刚性Solid	柔性Fine Stranded	带冷压头Furrule	刚性Solid	柔性Fine Stranded	带冷压头Furrule
	[mm ²]	0.2-1.5	0.2-1.5	0.2-1	0.2-2.5	0.2-2.5	0.2-1.5	0.2-4	0.2-4	0.2-2.5	0.2-1.5	0.2-1.5	0.2-1	0.2-2.5	0.2-2.5	0.2-1.5
	[AWG]	28-16	28-16	28-16	28-14	28-14	28-14	28-12	28-12	28-12	28-16	28-16	28-16	28-14	28-14	28-14
其余参数Other Parameters		绝缘材料/阻燃等级, 符合UL94 Insulating Material / Flame Retardant Grade, Conforming To UL94			V0			V0			V0			V0		
剥线长度Strip length	[mm]	8-9			8-9			9-10			8-9			8-9		
产品Product	颜色Colour	订货信息Order Information			订货信息Order Information			订货信息Order Information			订货信息Order Information			订货信息Order Information		
适配NS 35/7.5导轨 Can Be Used For DIN Rail NS 35/7.5	灰Gray	订货号Order NO.			订货号Order NO.			订货号Order NO.			订货号Order NO.			订货号Order NO.		
	橙Orange	215931			225931			204931			215901			225901		
	蓝Blue	215932			225932			204932			*			*		
		215934			225934			204934			215902			225902		
端板Cover Plate		配套附件Accessory			配套附件Accessory			配套附件Accessory			配套附件Accessory			配套附件Accessory		
	灰Gray	订货号Order NO.			订货号Order NO.			订货号Order NO.			订货号Order NO.			订货号Order NO.		
	橙Orange	215131			225131			204131			215101			225101		
	*	215132			225132			204132			215102			225102		
		*			*			*			*			*		
跨接件Jumper	颜色Colour	订货号Order NO.			订货号Order NO.			订货号Order NO.			订货号Order NO.			订货号Order NO.		
	灰Gray	215301			225301			204301			215301			225301		
相邻跨接桥Adjacent Jumper		*			225321-3			*			*			225321-3		
间隔跨接桥Staggered Jumper		*			225311(L=60mm) 225312(L=110mm) 225313(L=250mm)			*			*			225311(L=60mm) 225312(L=110mm) 225313(L=250mm)		
导线跨接桥Wire Jumper		订货号Order NO.			订货号Order NO.			订货号Order NO.			订货号Order NO.			订货号Order NO.		
安全警告标记 Protective Warning Marker		5位PCS			225701			204701			215701			225701		
		100PCS一片 (可提供印字服务Printing Service)			225801			225801			215801			225801		

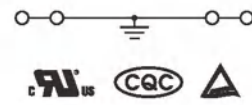
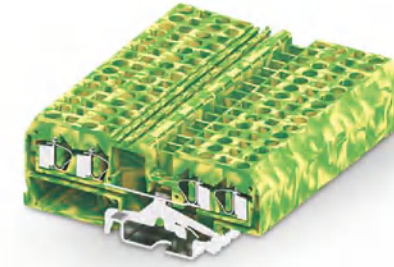
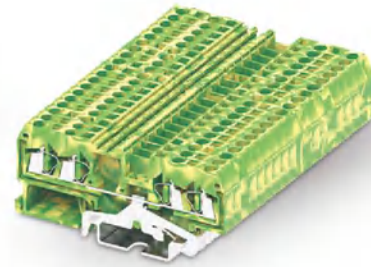
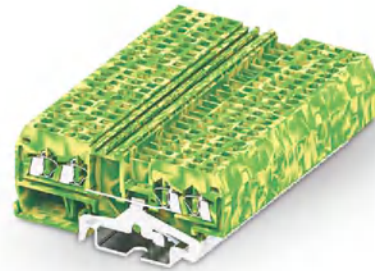

1.5mm² 两进两出接地端子
2-2 Feed Through Ground Terminal Block

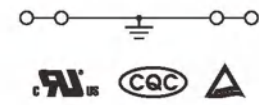

2.5mm² 两进两出接地端子
2-2 Feed Through Ground Terminal Block

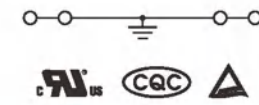

4mm² 两进两出接地端子
2-2 Feed Through Ground Terminal Block

尺寸Size	
注: 安装NS35/7.5导轨后的高度 Note: Height With DIN Rail NS 35/7.5	[mm]
额定参数Rated Parameters	
额定电压Rated Voltage	[V]
额定电流Rated Current	[A]
接线容量Wire Range	[mm ²] [AWG]
其余参数Other Parameters	
绝缘材料/阻燃等级, 符合UL94 Insulating Material / Flame Retardant Grade, Conforming To UL94	
剥线长度Strip length	[mm]
产品Product	
颜色Colour	黄绿Yellow green
适配NS 35/7.5导轨 Can Be Used For DIN Rail NS 35/7.5	*
端板Cover Plate	
颜色Colour	灰Gray
	橙Orange
	*
跨接件Jumper	
颜色Colour	灰Gray
相邻跨接桥Adjacent Jumper	
间隔跨接桥Staggered Jumper	
导线跨接桥Wire Jumper	
安全警告标记 Protective Warning Marker	
5位PCS	
正面标记和侧面标记Front And Side Marker	
100PCS一片 (可提供印字服务Printing Service)	

技术参数Technical Parameter		
厚度Thickness	宽度Width	高度Height
4	72.6	34.5
IEC	UL	
*	*	
*	*	
刚性Solid	柔性Fine Stranded	带冷压头Furrule
0.2-1.5	0.2-1.5	0.2-1
28-16	28-16	28-16
V0		
8-9		

订货信息Order Information	
订货号Order NO.	215947
*	*
*	*

配套附件Accessory	
订货号Order NO.	215131
	215132
*	*

订货号Order NO.	
*	*
*	*
*	*

订货号Order NO.	215701
订货号Order NO.	215801

技术参数Technical Parameter		
厚度Thickness	宽度Width	高度Height
5	75.9	35.5
IEC	UL	
*	*	
*	*	
刚性Solid	柔性Fine Stranded	带冷压头Furrule
0.2-2.5	0.2-2.5	0.2-1.5
28-14	28-14	28-14
V0		
8-9		

订货信息Order Information	
订货号Order NO.	225947
*	*
*	*

配套附件Accessory	
订货号Order NO.	225131
	225132
*	*

订货号Order NO.	
*	*
*	*
*	*

订货号Order NO.	225701
订货号Order NO.	225801

技术参数Technical Parameter		
厚度Thickness	宽度Width	高度Height
6	86.2	36
IEC	UL	
*	*	
*	*	
刚性Solid	柔性Fine Stranded	带冷压头Furrule
0.2-4	0.2-4	0.2-2.5
28-12	28-12	28-12
V0		
9-10		

订货信息Order Information	
订货号Order NO.	204947
*	*
*	*

配套附件Accessory	
订货号Order NO.	204131
	204132
*	*

订货号Order NO.	
*	*
*	*
*	*

订货号Order NO.	204701
订货号Order NO.	225801

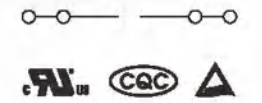
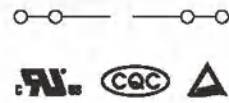
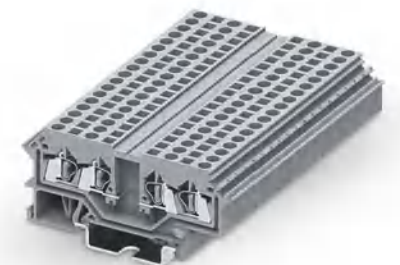

1.5mm² 两进两出分断式接线端子
2-2 Feed Through Terminal Block
With Interrupted Power Rail

2.5mm² 两进两出分断式接线端子
2-2 Feed Through Terminal Block
With Interrupted Power Rail

4mm² 两进两出分断式接线端子
2-2 Feed Through Terminal Block
With Interrupted Power Rail

1.5mm² 两进两出分断式接线端子(侧面标记)
2-2 Feed Through Terminal Block
With Interrupted Power Rail(Side Marking)

2.5mm² 两进两出分断式接线端子(侧面标记)
2-2 Feed Through Terminal Block
With Interrupted Power Rail(Side Marking)

尺寸Size	技术参数Technical Parameter			技术参数Technical Parameter			技术参数Technical Parameter			技术参数Technical Parameter			技术参数Technical Parameter			
	厚度Thickness	宽度Width	高度Height	厚度Thickness	宽度Width	高度Height	厚度Thickness	宽度Width	高度Height	厚度Thickness	宽度Width	高度Height	厚度Thickness	宽度Width	高度Height	
注: 安装NS35/7.5导轨后的高度 Note: Height With DIN Rail NS 35/7.5	[mm]	4	72.6	34.5	5	75.9	35.5	6	86.2	36	4	68	34.5	5	73	35.5
额定参数Rated Parameters		IEC	UL		IEC	UL		IEC	UL		IEC	UL		IEC	UL	
额定电压Rated Voltage	[V]	800	600		800	600		800	600		800	600		800	600	
额定电流Rated Current	[A]	18	10		24	20		32	20		18	10		24	20	
接线容量Wire Range		刚性Solid	柔性Fine Stranded	带冷压头Furrule	刚性Solid	柔性Fine Stranded	带冷压头Furrule	刚性Solid	柔性Fine Stranded	带冷压头Furrule	刚性Solid	柔性Fine Stranded	带冷压头Furrule	刚性Solid	柔性Fine Stranded	带冷压头Furrule
	[mm ²]	0.2-1.5	0.2-1.5	0.2-1	0.2-2.5	0.2-2.5	0.2-1.5	0.2-4	0.2-4	0.2-2.5	0.2-1.5	0.2-1.5	0.2-1	0.2-2.5	0.2-2.5	0.2-1.5
	[AWG]	28-16	28-16	28-16	28-14	28-14	28-14	28-12	28-12	28-12	28-16	28-16	28-16	28-14	28-14	28-14
其余参数Other Parameters		绝缘材料/阻燃等级, 符合UL94 Insulating Material / Flame Retardant Grade, Conforming To UL94			V0			V0			V0			V0		
剥线长度Strip length	[mm]	8-9			8-9			9-10			8-9			8-9		
产品信息Product	颜色Colour	订货信息Order Information			订货信息Order Information			订货信息Order Information			订货信息Order Information			订货信息Order Information		
适配NS 35/7.5导轨 Can Be Used For DIN Rail NS 35/7.5	灰Gray	订货号Order NO.			订货号Order NO.			订货号Order NO.			订货号Order NO.			订货号Order NO.		
	橙Orange	215936			225936			204936			215903			225903		
	蓝Blue	215937			225937			204937			*			*		
		215939			225939			204939			215904			225904		
端板Cover Plate	颜色Colour	配套附件Accessory			配套附件Accessory			配套附件Accessory			配套附件Accessory			配套附件Accessory		
	灰Gray	订货号Order NO.			订货号Order NO.			订货号Order NO.			订货号Order NO.			订货号Order NO.		
	橙Orange	215131			225131			204131			215101			225101		
	*	215132			225132			204132			215102			225102		
	*	*			*			*			*			*		
跨接件Jumper	颜色Colour	订货号Order NO.			订货号Order NO.			订货号Order NO.			订货号Order NO.			订货号Order NO.		
	灰Gray	215701			225701			204701			215701			225701		
相邻跨接桥Adjacent Jumper		*			*			*			*			*		
间隔跨接桥Staggered Jumper		*			*			*			*			*		
导线跨接桥Wire Jumper		*			*			*			*			*		
安全警告标记 Protective Warning Marker		订货号Order NO.			订货号Order NO.			订货号Order NO.			订货号Order NO.			订货号Order NO.		
5位PCS		215801			225801			204801			215801			225801		
正面标记和侧面标记Front And Side Marker		215801			225801			225801			225801			225801		
100PCS一片 (可提供印字服务Printing Service)		215801			225801			225801			225801			225801		

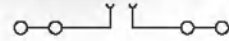
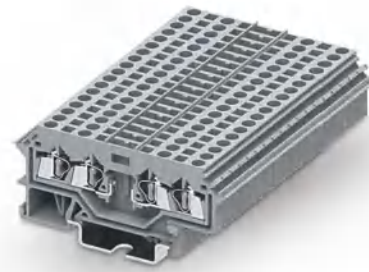

2.5mm² 两进两出分断式保险丝接线端子(侧面标记)
2-2 Feed Through Fuse Terminal Block With Interrupted Power Rail(Side Marking)

尺寸Size		技术参数Technical Parameter		
注: 安装NS35/7.5导轨后的高度 Note: Height With DIN Rail NS 35/7.5		厚度Thickness	宽度Width	高度Height
额定电压Rated Voltage	[V]	5	72.6	35.5
额定电流Rated Current	[A]	IEC	UL	
接线容量Wire Range	[mm ²]	800	600	
	[AWG]	24	20	
其余参数Other Parameters		刚性Solid	柔性Fine Stranded	带冷压头Furrule
绝缘材料/阻燃等级, 符合UL94 Insulating Material / Flame Retardant Grade, Conforming To UL94		0.2-2.5	0.2-2.5	0.2-1.5
剥线长度Strip length	[mm]	28-14	28-14	28-14
				V0

产品信息Product		颜色Colour		订货信息Order Information	
适配NS 35/7.5导轨 Can Be Used For DIN Rail NS 35/7.5		灰Gray	橙Orange	订货号Order NO.	225908
		蓝Blue			*

端板Cover Plate		订货信息Order Information	
	灰Gray	订货号Order NO.	225101
	橙Orange		225102

跨接件Jumper		订货信息Order NO.	
相邻跨接桥Adjacent Jumper	灰Gray		*
间隔跨接桥Staggered Jumper			*
导线跨接桥Wire Jumper			*

安全警告标记 Protective Warning Marker		订货信息Order NO.	
5位PCS		订货号Order NO.	225701
正面标记和侧面标记Front And Side Marker		订货号Order NO.	225801

保险丝盒订货号:
225221(可接发光管220V)、225231(普通型)
适用于: 225908、G型
保险管规格5x20mm和5x25mm

Fuse Box P/N:
225221(For LED Light 220V), 225231(Normal Type)
App for: 225908, G Type
Fuse Size: 5x20mm, 5x25mm



2.5mm² 一进两出斜面接线端子
1-2 Feed Through Angled Type Terminal Block

尺寸Size		技术参数Technical Parameter		
注: 安装NS35/7.5导轨后的高度 Note: Height With DIN Rail NS 35/7.5		厚度Thickness	宽度Width	高度Height
额定电压Rated Voltage	[V]	5	50	43.5
额定电流Rated Current	[A]	IEC	UL	
接线容量Wire Range	[mm ²]	800	600	
	[AWG]	24	20	
其余参数Other Parameters		刚性Solid	柔性Fine Stranded	带冷压头Furrule
绝缘材料/阻燃等级, 符合UL94 Insulating Material / Flame Retardant Grade, Conforming To UL94		0.2-2.5	0.2-2.5	0.2-1.5
剥线长度Strip length	[mm]	28-14	28-14	28-14
				V0

产品信息Product		颜色Colour		订货信息Order Information	
适配NS 35/7.5导轨 Can Be Used For DIN Rail NS 35/7.5		灰Gray	橙Orange	订货号Order NO.	225961
		蓝Blue			225962
					225963

端板Cover Plate		订货信息Order NO.	
	灰Gray	订货号Order NO.	225161
	橙Orange		225162

跨接件Jumper		订货信息Order NO.	
相邻跨接桥Adjacent Jumper	灰Gray		225301
间隔跨接桥Staggered Jumper			225321-3
导线跨接桥Wire Jumper			225311(L=60mm) 225312(L=110mm) 225313(L=250mm)

安全警告标记 Protective Warning Marker		订货信息Order NO.	
5位PCS		订货号Order NO.	225701
正面标记和侧面标记Front And Side Marker		订货号Order NO.	225801



4mm² 一进两出斜面接线端子
1-2 Feed Through Angled Type Terminal Block

尺寸Size		技术参数Technical Parameter		
注: 安装NS35/7.5导轨后的高度 Note: Height With DIN Rail NS 35/7.5		厚度Thickness	宽度Width	高度Height
额定电压Rated Voltage	[V]	6	61.2	43.5
额定电流Rated Current	[A]	IEC	UL	
接线容量Wire Range	[mm ²]	800	600	
	[AWG]	32	20	
其余参数Other Parameters		刚性Solid	柔性Fine Stranded	带冷压头Furrule
绝缘材料/阻燃等级, 符合UL94 Insulating Material / Flame Retardant Grade, Conforming To UL94		0.2-4	0.2-4	0.2-2.5
剥线长度Strip length	[mm]	28-12	28-12	28-12
				V0

产品信息Product		颜色Colour		订货信息Order Information	
适配NS 35/7.5导轨 Can Be Used For DIN Rail NS 35/7.5		灰Gray	橙Orange	订货号Order NO.	204961
		蓝Blue			204962
					204963

端板Cover Plate		订货信息Order NO.	
	灰Gray	订货号Order NO.	204161
	橙Orange		204162

跨接件Jumper		订货信息Order NO.	
相邻跨接桥Adjacent Jumper	灰Gray		204301
间隔跨接桥Staggered Jumper			*
导线跨接桥Wire Jumper			*

安全警告标记 Protective Warning Marker		订货信息Order NO.	
5位PCS		订货号Order NO.	204701
正面标记和侧面标记Front And Side Marker		订货号Order NO.	225801



2.5mm² 两进两出斜面接线端子
2-2 Feed Through Angled Type Terminal Block

尺寸Size		技术参数Technical Parameter		
厚度Thickness	宽度Width	高度Height		
注: 安装NS35/7.5导轨后的高度 Note: Height With DIN Rail NS 35/7.5	[mm]	5	50.2	43.5
额定参数Rated Parameters		IEC	UL	
额定电压Rated Voltage	[V]	800	600	
额定电流Rated Current	[A]	24	20	
接线容量Wire Range		刚性Solid	柔性Fine Stranded	带冷压头Furrule
	[mm ²]	0.2-2.5	0.2-2.5	0.2-1.5
	[AWG]	28-14	28-14	28-14
其余参数Other Parameters		绝缘材料/阻燃等级, 符合UL94 Insulating Material / Flame Retardant Grade, Conforming To UL94		
剥线长度Strip length	[mm]	8-9		
产品Product		颜色Colour		
适配NS 35/7.5导轨 Can Be Used For DIN Rail NS 35/7.5		灰Gray	225965	
		橙Orange	225966	
		蓝Blue	225967	
端板Cover Plate		订货号Order NO.		
		灰Gray	225161	
		橙Orange	225162	
		*	*	
跨接件Jumper		颜色Colour		
		灰Gray	订货号Order NO.	
相邻跨接桥Adjacent Jumper		*	*	
间隔跨接桥Staggered Jumper		*	*	
导线跨接桥Wire Jumper		*	*	
安全警告标记 Protective Warning Marker		订货号Order NO.		
5位PCS		225701		
正面标记和侧面标记Front And Side Marker		订货号Order NO.		
100PCS一片 (可提供印字服务Printing Service)		225801		

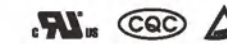

2.5mm² 一进两出斜面接地端子
1-2 Feed Through Ground Angled Type Terminal Block

尺寸Size		技术参数Technical Parameter		
厚度Thickness	宽度Width	高度Height		
注: 安装NS35/7.5导轨后的高度 Note: Height With DIN Rail NS 35/7.5	[mm]	5	50	43.5
额定参数Rated Parameters		IEC	UL	
额定电压Rated Voltage	[V]	*	*	
额定电流Rated Current	[A]	*	*	
接线容量Wire Range		刚性Solid	柔性Fine Stranded	带冷压头Furrule
	[mm ²]	0.2-2.5	0.2-2.5	0.2-1.5
	[AWG]	28-14	28-14	28-14
其余参数Other Parameters		绝缘材料/阻燃等级, 符合UL94 Insulating Material / Flame Retardant Grade, Conforming To UL94		
剥线长度Strip length	[mm]	8-9		
产品Product		颜色Colour		
适配NS 35/7.5导轨 Can Be Used For DIN Rail NS 35/7.5		黄绿Yellow green	225964	
		*	*	
		*	*	
端板Cover Plate		订货号Order NO.		
		灰Gray	225161	
		橙Orange	225162	
		*	*	
跨接件Jumper		颜色Colour		
		灰Gray	订货号Order NO.	
相邻跨接桥Adjacent Jumper		*	*	
间隔跨接桥Staggered Jumper		*	*	
导线跨接桥Wire Jumper		*	*	
安全警告标记 Protective Warning Marker		订货号Order NO.		
5位PCS		225701		
正面标记和侧面标记Front And Side Marker		订货号Order NO.		
100PCS一片 (可提供印字服务Printing Service)		225801		



4mm² 一进两出斜面接地端子
1-2 Feed Through Ground Angled Type Terminal Block

尺寸Size		技术参数Technical Parameter		
厚度Thickness	宽度Width	高度Height		
注: 安装NS35/7.5导轨后的高度 Note: Height With DIN Rail NS 35/7.5	[mm]	6	61.2	43.5
额定参数Rated Parameters		IEC	UL	
额定电压Rated Voltage	[V]	*	*	
额定电流Rated Current	[A]	*	*	
接线容量Wire Range		刚性Solid	柔性Fine Stranded	带冷压头Furrule
	[mm ²]	0.2-4	0.2-4	0.2-2.5
	[AWG]	28-12	28-12	28-12
其余参数Other Parameters		绝缘材料/阻燃等级, 符合UL94 Insulating Material / Flame Retardant Grade, Conforming To UL94		
剥线长度Strip length	[mm]	9-10		
产品Product		颜色Colour		
适配NS 35/7.5导轨 Can Be Used For DIN Rail NS 35/7.5		灰Gray	204964	
		*	*	
		*	*	
端板Cover Plate		订货号Order NO.		
		灰Gray	204161	
		橙Orange	204162	
		*	*	
跨接件Jumper		颜色Colour		
		灰Gray	订货号Order NO.	
相邻跨接桥Adjacent Jumper		*	*	
间隔跨接桥Staggered Jumper		*	*	
导线跨接桥Wire Jumper		*	*	
安全警告标记 Protective Warning Marker		订货号Order NO.		
5位PCS		204701		
正面标记和侧面标记Front And Side Marker		订货号Order NO.		
100PCS一片 (可提供印字服务Printing Service)		225801		

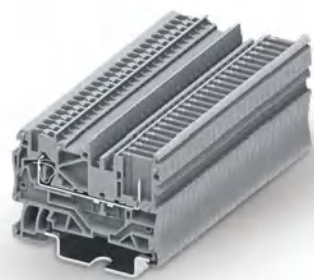
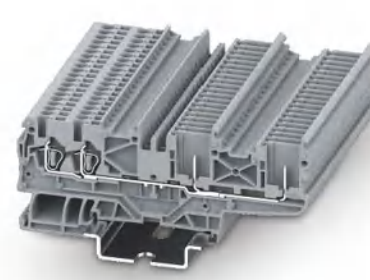
1.5mm² 一针一线插拔式接线端子
1-1 Feed Through Pluggable Terminal Block2.5mm² 一针一线插拔式接线端子
1-1 Feed Through Pluggable Terminal Block1.5mm² 两针两线插拔式接线端子
2-2 Feed Through Pluggable Terminal Block

尺寸Size	
注: 安装NS35/7.5导轨后的高度 Note: Height With DIN Rail NS 35/7.5	[mm]
额定参数Rated Parameters	
额定电压Rated Voltage	[V]
额定电流Rated Current	[A]
接线容量Wire Range	
	[mm ²]
	[AWG]
其余参数Other Parameters	
绝缘材料/阻燃等级, 符合UL94 Insulating Material / Flame Retardant Grade, Conforming To UL94	
剥线长度Strip length	[mm]
产品Product	
颜色Colour	灰Gray
	橙Orange
	蓝Blue
适配NS 35/7.5导轨 Can Be Used For DIN Rail NS 35/7.5	
端板Cover Plate	
	灰Gray
	橙Orange
跨接件Jumper	
	灰Gray
相邻跨接桥Adjacent Jumper	
间隔跨接桥Staggered Jumper	
导线跨接桥Wire Jumper	
安全警告标记Protective Warning Marker	
5位PCS	
正面标记和侧面标记Front And Side Marker	
100PCS一片 (可提供印字服务Printing Service)	

技术参数Technical Parameter		
厚度Thickness	宽度Width	高度Height
3.5	49.5	29.6
IEC	UL	
500	300	
13.5	10	
刚性Solid	柔性Fine Stranded	带冷压头Furrule
0.2-1.5	0.2-1.5	0.2-1
24-16	24-16	24-16
V0		
8-9		

订货信息Order Information	
订货号Order NO.	2150-1201
	2150-1202
	2150-1204

配套附件Accessory	
订货号Order NO.	2150-1291
	2150-1292

订货号Order NO.	2150-302~2150-320 注: (2-20位梳状跨接桥)
	2150-402~2150-410 注: (2-20位跨盖板跨接桥)
	*

订货号Order NO.	215701
订货号Order NO.	2150-801

技术参数Technical Parameter		
厚度Thickness	宽度Width	高度Height
5	53	35.5
IEC	UL	
800	600	
24	20	
刚性Solid	柔性Fine Stranded	带冷压头Furrule
0.2-2.5	0.2-2.5	0.2-1.5
28-14	28-14	28-14
V0		
8-9		

订货信息Order Information	
订货号Order NO.	225981
	225982
	225984

配套附件Accessory	
订货号Order NO.	225181
	225182

订货号Order NO.	225301
	225321-3
	225311(L=60mm) 225312(L=110mm) 225313(L=250mm)

订货号Order NO.	225701
订货号Order NO.	225801

技术参数Technical Parameter		
厚度Thickness	宽度Width	高度Height
3.5	85.8	29.6
IEC	UL	
500	300	
13.5	10	
刚性Solid	柔性Fine Stranded	带冷压头Furrule
0.2-1.5	0.2-1.5	0.2-1
24-16	24-16	24-16
V0		
8-9		

订货信息Order Information	
订货号Order NO.	2150-1401
	2150-1402
	2150-1404

配套附件Accessory	
订货号Order NO.	2150-1491
	2150-1492

订货号Order NO.	2150-302~2150-320
	2150-402~2150-410
	*

订货号Order NO.	215701
订货号Order NO.	2150-801

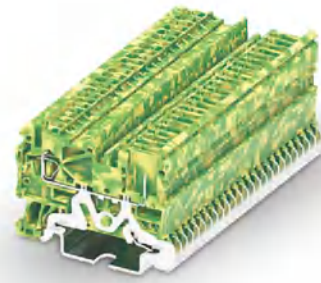
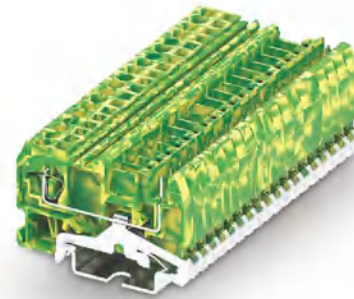
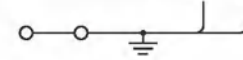
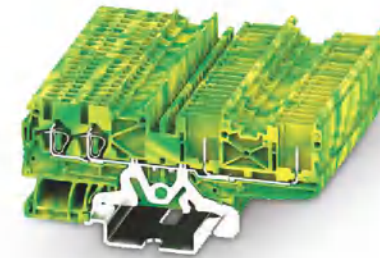
1.5mm² 一针一线插拔式接地端子
1-1 Feed Through Ground Pluggable Terminal Block2.5mm² 一针一线插拔式接地端子
1-1 Feed Through Ground Pluggable Terminal Block1.5mm² 两针两线插拔式接地端子
2-2 Feed Through Ground Pluggable Terminal Block1.5mm² 插头
Plug

尺寸Size	
注: 安装NS35/7.5导轨后的高度 Note: Height With DIN Rail NS 35/7.5	[mm]
额定参数Rated Parameters	
额定电压Rated Voltage	[V]
额定电流Rated Current	[A]
接线容量Wire Range	
	[mm ²]
	[AWG]
其余参数Other Parameters	
绝缘材料/阻燃等级, 符合UL94 Insulating Material / Flame Retardant Grade, Conforming To UL94	
剥线长度Strip length	[mm]

技术参数Technical Parameter		
厚度Thickness	宽度Width	高度Height
3.5	49.5	29.6
额定参数Rated Parameters		
IEC	UL	
*	*	
*	*	
接线容量Wire Range		
刚性Solid	柔性Fine Stranded	带冷压头Furrule
0.2-1.5	0.2-1.5	0.2-1
24-16	24-16	24-16
其余参数Other Parameters		
绝缘材料/阻燃等级, 符合UL94 Insulating Material / Flame Retardant Grade, Conforming To UL94		
剥线长度Strip length		
8-9		

技术参数Technical Parameter		
厚度Thickness	宽度Width	高度Height
5	53	35.5
额定参数Rated Parameters		
IEC	UL	
*	*	
*	*	
接线容量Wire Range		
刚性Solid	柔性Fine Stranded	带冷压头Furrule
0.2-2.5	0.2-2.5	0.2-1.5
28-14	28-14	28-14
其余参数Other Parameters		
绝缘材料/阻燃等级, 符合UL94 Insulating Material / Flame Retardant Grade, Conforming To UL94		
剥线长度Strip length		
8-9		

技术参数Technical Parameter		
厚度Thickness	宽度Width	高度Height
3.5	85.8	29.6
额定参数Rated Parameters		
IEC	UL	
*	*	
*	*	
接线容量Wire Range		
刚性Solid	柔性Fine Stranded	带冷压头Furrule
0.2-1.5	0.2-1.5	0.2-1
24-16	24-16	24-16
其余参数Other Parameters		
绝缘材料/阻燃等级, 符合UL94 Insulating Material / Flame Retardant Grade, Conforming To UL94		
剥线长度Strip length		
8-9		

尺寸Size		
		[mm]
额定参数Rated Parameters		
额定电压Rated Voltage	[V]	
额定电流Rated Current	[A]	
接线容量Wire Range		
		[mm ²]
		[AWG]
其余参数Other Parameters		
绝缘材料/阻燃等级, 符合UL94 Insulating Material / Flame Retardant Grade, Conforming To UL94		
剥线长度Strip length		
[mm]		

技术参数Technical Parameter		
厚度Thickness	宽度Width	高度Height
(P*3.5+1)	38.95	21.5
额定参数Rated Parameters		
IEC	UL	
500	300	
13.5	10	
接线容量Wire Range		
刚性Solid	柔性Fine Stranded	带冷压头Furrule
0.2-1.5	0.2-1.5	0.2-1
24-16	24-16	24-16
其余参数Other Parameters		
绝缘材料/阻燃等级, 符合UL94 Insulating Material / Flame Retardant Grade, Conforming To UL94		
剥线长度Strip length		
8-9		

产品Product	
颜色Colour	黄绿Yellow green
适配NS 35/7.5导轨 Can Be Used For DIN Rail NS 35/7.5	*

订货信息Order Information	
订货号Order NO.	2150-1207
	*
	*

订货信息Order Information	
订货号Order NO.	225987
	*
	*

订货信息Order Information	
订货号Order NO.	2150-1407
	*
	*

产品Product	位数Pole No.	颜色Colour
	1	灰Gray

	15	灰Gray

订货信息Order Information	
订货号Order NO.	2150-101
	...
	2150-115

端板Cover Plate	
颜色Colour	灰Gray
端板Cover Plate	橙Orange
	*

配套附件Accessory	
订货号Order NO.	2150-1291
	2150-1292
	*

配套附件Accessory	
订货号Order NO.	225181
	225182
	*

配套附件Accessory	
订货号Order NO.	2150-1491
	2150-1492
	*

端板Cover Plate	
颜色Colour	灰Gray
端板Cover Plate (2150-1XX已包含盖板)	橙Orange
	*

配套附件Accessory	
订货号Order NO.	*
	*
	*

跨接件Jumper	
颜色Colour	灰Gray
跨接件Jumper	
相邻跨接桥Adjacent Jumper	
间隔跨接桥Staggered Jumper	
导线跨接桥Wire Jumper	

跨接件Jumper	
订货号Order NO.	*
	*
	*
	*

跨接件Jumper	
订货号Order NO.	*
	*
	*
	*

跨接件Jumper	
订货号Order NO.	*
	*
	*
	*

跨接件Jumper	
颜色Colour	灰Gray
跨接件Jumper	
相邻跨接桥Adjacent Jumper	
间隔跨接桥Staggered Jumper	
导线跨接桥Wire Jumper	

跨接件Jumper	
订货号Order NO.	*
	*
	*
	*

安全警告标记 Protective Warning Marker	
5位PCS	
正面标记和侧面标记Front And Side Marker	
100PCS一片 (可提供印字服务Printing Service)	

安全警告标记 Protective Warning Marker	
订货号Order NO.	215701
	215701
	215701

安全警告标记 Protective Warning Marker	
订货号Order NO.	225701
	225701
	225701

安全警告标记 Protective Warning Marker	
订货号Order NO.	215701
	215701
	215701

安全警告标记 Protective Warning Marker	
订货号Order NO.	225701
	225701
	225701

安全警告标记 Protective Warning Marker	
订货号Order NO.	215701
	215701
	215701

UK系列螺钉接线端子

UK Rail-mounted Terminal Blocks With Screw Clamp

UK系列螺钉接线端子使用螺钉压线框技术，能够完成各种客户需求的端子组合并提供丰富的组合端子附件供客户挑选使用。能够最大程度的保证客户操作的舒适性，既节省了占用空间又便于操作实现。广泛应用于各种低压电力设备的控制连接转换。产品设计制造符合IEC60947、UL1059等国际标准，并取得CQC、UL、VDE、TUV、CE、ROHS等认证。

UK series rail-mounted screw terminal blocks use screw pressure wire frame technology, is able to complete the terminal connection of a variety of customers' needs and provide a rich combination of terminal accessories. Able to ensure the greatest degree of customers operations comfort, save space and easy to operate. It widely used in the control of the respective low-voltage electrical equipment. Product design and manufacturing in line with relevant international standards such as IEC60947, UL1059 and achieved CQC, UL, VDE, CE, ROHS certification.

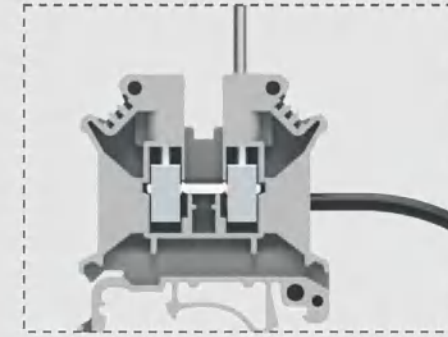
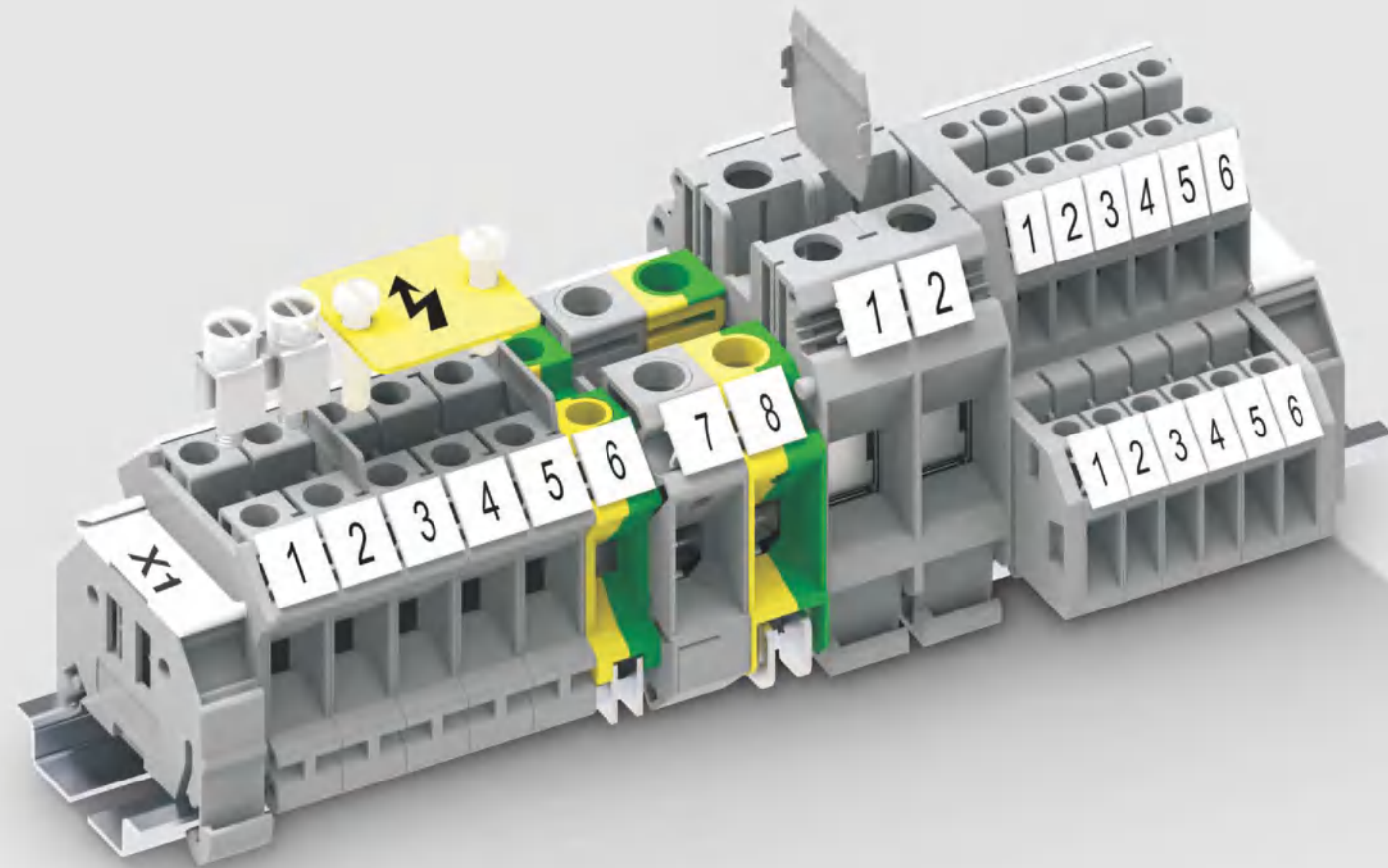

螺钉接线 Screw Connection

- ▲ 具有稳定优良的接触特性，连接可靠，接触应用广泛
- ▲ It has stable contact characteristics, reliable connection and widely used



螺钉材料 Screw Material

- ▲ 具有铜/钢两种材料的螺钉，为客户提供多种选择
- ▲ Material option: Brass or steel

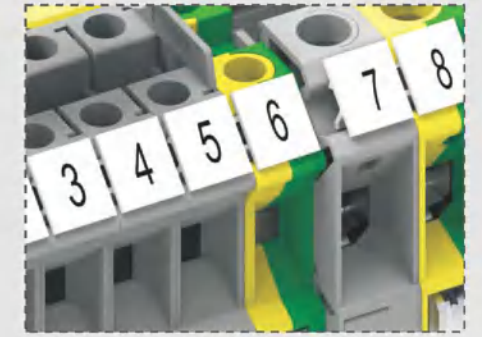

标识 Marking

- ▲ 清晰的标记可为端子的安装提供安全、快速的保障
- ▲ Clear marking can provide safety and fast guarantee for terminal installation

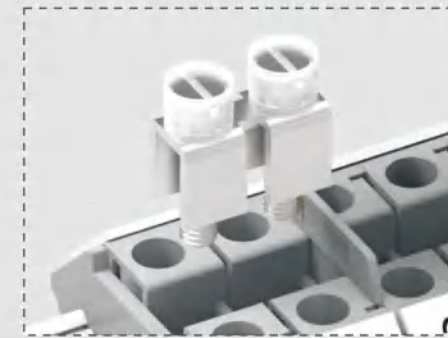

跨接系统 Jumper Connector System

- ▲ 使用螺钉固定的跨接件
- ▲ Use the jumper fixed with screws



警告标识 Warning Marker

- ▲ 大片的标识，明显的标识出警告位置
- ▲ Big maker, clearly indicate the warning position



端子挡板 Terminal Board

- ▲ 可对端子进行清晰的分组
- ▲ Terminal blocks can be grouped clearly

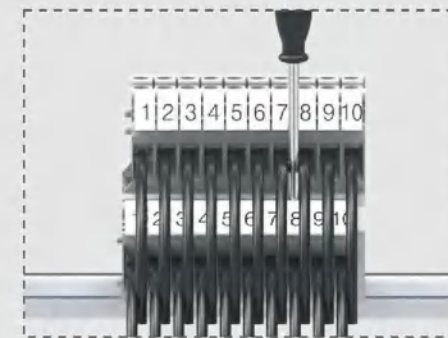

双层端子 Double Deck Terminal Block

- ▲ 上下两层采用错开设计：便于螺丝刀对于下层的操作，可看清下层的标记和导线
- ▲ Staggered design for upper and lower layer: Easy for the screwdriver to operate the lower layer, and can see the marking and wire clearly in lower layer



保险管端子 Terminal Block With Fuse

- ▲ 内部安装保险管，可满足相应电路设计
- ▲ Install the fuse inside, to meet the corresponding circuit design

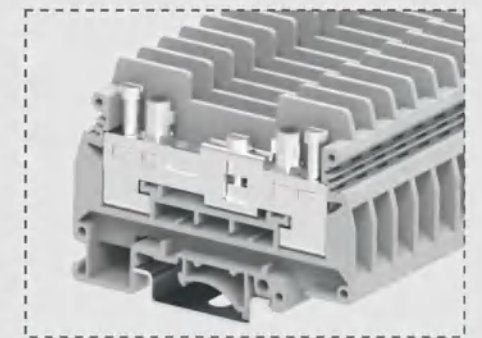

分断测试端子 Disconnect Test Terminal Block

- ▲ 可实现电流互感器二次回路的各种测试连接
- ▲ Can achieve the various testing connect of secondary circuit of current transformer

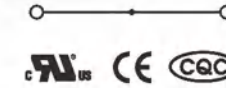
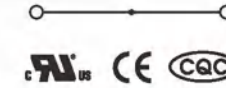
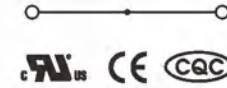
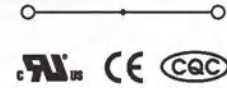
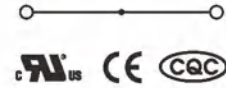
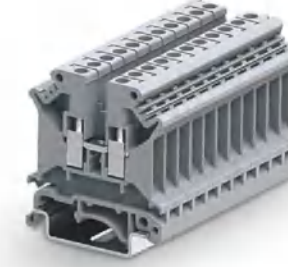
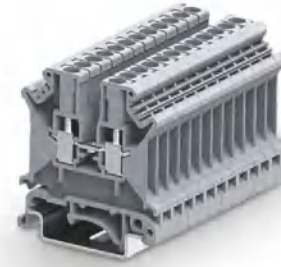
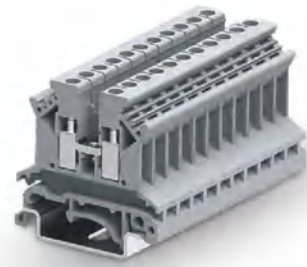

1.5mm² UK接线端子
UK Terminal Block

2.5mm² UK接线端子
UK Terminal Block

2.5mm² UK接线端子
UK Terminal Block

4mm² UK接线端子
UK Terminal Block

6mm² UK接线端子
UK Terminal Block

尺寸Size	技术参数Technical Parameter			厚度Thickness	宽度Width	高度Height
	厚度Thickness	宽度Width	高度Height			
	4.2	42.5	42			
额定参数Rated Parameters	IEC	UL				
额定电压Rated Voltage [V]	500	300				
额定电流Rated Current [A]	17.5	15				
接线容量Wire Range	刚性Solid 柔性Fine Stranded 带冷压头Furrule			刚性Solid 柔性Fine Stranded 带冷压头Furrule		
[mm ²]	0.14-1.5	0.14-1.5	0.14-1.5	0.2-4	0.2-2.5	0.25-2.5
[AWG]	30-14	30-14	30-14	30-12	30-12	30-12
螺钉类型Screw Type [*]	M2			M3		
扭矩Torque [N.m]	0.2-0.25			0.6-0.8		
其余参数Other Parameters	绝缘材料/阻燃等级, 符合UL94 Insulating Material / Flame Retardant Grade, Conforming To UL94			V0		
剥线长度Strip length [mm]	7			7-8		
产品Product	颜色Colour			订货信息Order Information		
	灰Gray			订货号Order NO.		
	橙Orange			301901		
	蓝Blue			301904		
				301902		
				302901		
				302904		
				302902		
				302902		
端板Cover Plate	颜色Colour			配套附件Accessory		
	灰Gray			订货号Order NO.		
	橙Orange			302101		
	蓝Blue			302102		
				*		
隔板Intermediate Plate	灰Gray			*		
跨接件Jumper	颜色Colour			订货号Order NO.		
	灰Gray			2		
	橙Orange			3		
	蓝Blue			4		
				...		
				9		
				10		
安全警告标记 Protective Warning Marker	灰Gray			订货号Order NO.		
				*		
正面标记和侧面标记 Front And Side Marker	灰Gray			订货号Order NO.		
				*		
可提供印字服务 Printing Service				订货号Order NO.		
				306801		

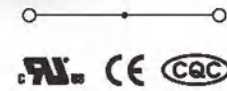
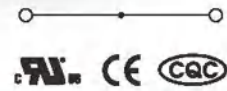
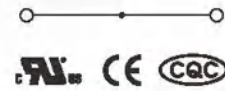
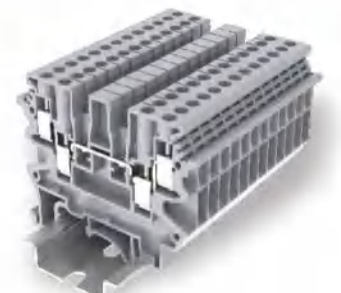
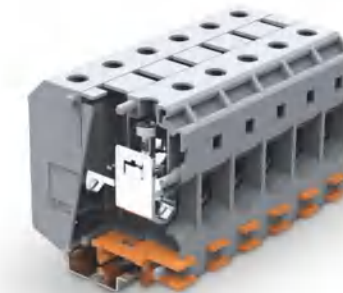
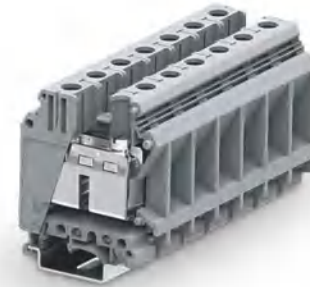

10mm² UK接线端子
UK Terminal Block

16mm² UK接线端子
UK Terminal Block

35mm² UK接线端子
UK Terminal Block

50mm² UK接线端子
UK Terminal Block

2.5mm², UK二进二出接线端子
2-2 Feed Through Terminal Block

尺寸Size	
注: 安装NS35/7.5导轨后的高度 Note: Height With DIN Rail NS 35/7.5	[mm]
额定参数Rated Parameters	
额定电压Rated Voltage	[V]
额定电流Rated Current	[A]
接线容量Wire Range	
	[mm²]
	[AWG]
螺钉类型Screw Type	[*]
扭矩Torque	[N.m]
其余参数Other Parameters	
绝缘材料/阻燃等级, 符合UL94 Insulating Material / Flame Retardant Grade, Conforming To UL94	
剥线长度Strip length	[mm]

技术参数Technical Parameter		
厚度Thickness	宽度Width	高度Height
10	42.2	46.8
IEC	UL	
800	600	
57	65	
刚性Solid	柔性Fine Stranded	带冷压头Furrule
0.5-16	0.5-10	0.5-6
24-6	24-6	24-6
M4		
1.2-1.5		
V0		
10-11		

技术参数Technical Parameter		
厚度Thickness	宽度Width	高度Height
12	42.2	53.7
IEC	UL	
800	600	
76	85	
刚性Solid	柔性Fine Stranded	带冷压头Furrule
2.5-25	4-16	1.5-16
22-4	22-4	22-4
M4		
1.2-1.5		
V0		
11-12		

技术参数Technical Parameter		
厚度Thickness	宽度Width	高度Height
15	50.3	62.3
UL		
1000	600	
125	150	
刚性Solid	柔性Fine Stranded	带冷压头Furrule
0.75-50	0.75-35	0.75-35
18-1/0	18-1/0	18-1/0
M6		
3.0-3.5		
V0		
16-17		

技术参数Technical Parameter		
厚度Thickness	宽度Width	高度Height
20.4	70.7	76.1
IEC	UL	
1000	600	
150	150	
刚性Solid	柔性Fine Stranded	带冷压头Furrule
16-70	25-70	25-50
6-2/0	6-2/0	6-2/0
M6		
6-8		
V0		
24		

技术参数Technical Parameter		
厚度Thickness	宽度Width	高度Height
5.2	58	45.9
IEC	UL	
500	300	
24	20	
刚性Solid	柔性Fine Stranded	带冷压头Furrule
0.2-4	0.2-2.5	0.2-2.5
24-12	24-12	24-12
M3		
0.5-0.6		
V0		
8-9		

产品Product		颜色Colour
适配NS 35/7.5导轨 Can Be Used For DIN Rail NS 35/7.5		灰Gray
		橙Orange
		蓝Blue

订货信息Order Information	
订货号Order NO.	
310901	
310904	
310902	

订货信息Order Information	
订货号Order NO.	
316901	
316904	
316902	

订货信息Order Information	
订货号Order NO.	
335901	
335904	
335902	

订货信息Order Information	
订货号Order NO.	
350901	
*	
*	

订货信息Order Information	
订货号Order NO.	
303941	
303944	
303942	

盖板Cover Plate		颜色Colour
盖板Cover Plate		灰Gray
盖板Cover Plate		橙Orange
隔板Intermediate Plate		灰Gray

配套附件Accessory	
订货号Order NO.	
303101	
303102	
302151	

配套附件Accessory	
订货号Order NO.	
316101	
316102	
302151	

配套附件Accessory	
订货号Order NO.	
*	
*	
302151	

配套附件Accessory	
订货号Order NO.	
*	
*	
*	

配套附件Accessory	
订货号Order NO.	
303141	
303142	
*	

跨接件Jumper	
位数Poles No.	订货号Order NO.
2	310302
3	310303
4	310304
...
9	310309
10	310310

跨接件Jumper	
位数Poles No.	订货号Order NO.
2	316302
3	316303
4	316304
...
9	316309
10	316310

跨接件Jumper	
位数Poles No.	订货号Order NO.
2	335302
3	335303
4	335304
...
9	335309
10	335310

跨接件Jumper	
位数Poles No.	订货号Order NO.
2	*
3	*
4	*
...
9	*
10	*

跨接件Jumper	
位数Poles No.	订货号Order NO.
2	303302
3	303303
4	303304
...
9	303309
10	303310

安全警告标记 Protective Warning Marker	
订货号Order NO.	
310701	

安全警告标记 Protective Warning Marker	
订货号Order NO.	
310701	

安全警告标记 Protective Warning Marker	
订货号Order NO.	
316701	

安全警告标记 Protective Warning Marker	
订货号Order NO.	
310801	

安全警告标记 Protective Warning Marker	
订货号Order NO.	
315801	

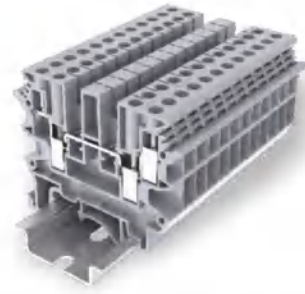

4mm², UK二进二出接线端子
2-2 Feed Through Terminal Block

尺寸Size		技术参数Technical Parameter			
厚度Thickness	宽度Width	高度Height			
注: 安装NS35/7.5导轨后的高度 Note: Height With DIN Rail NS 35/7.5	[mm]	6.2	58	45.9	
额定参数Rated Parameters					
额定电压Rated Voltage	[V]	630	600		
额定电流Rated Current	[A]	32	30		
接线容量Wire Range					
	[mm²]	刚性Solid	柔性Fine Stranded	带冷压头Furrule	
	[AWG]	0.2-6	0.2-4	0.2-4	
螺钉类型Screw Type	[*]	M3			
扭矩Torque	[N.m]	0.5-0.6			
其余参数Other Parameters					
绝缘材料/阻燃等级, 符合UL94 Insulating Material / Flame Retardant Grade, Conforming To UL94		V0			
剥线长度Strip length	[mm]	8-9			
订货信息Order Information					
产品Product	颜色Colour	订货号Order NO.			
适配NS 35/7.5导轨 Can Be Used For DIN Rail NS 35/7.5	灰Gray	305941			
	橙Orange	305944			
	蓝Blue	305942			
配套附件Accessory					
端板Cover Plate	颜色Colour	订货号Order NO.			
端板Cover Plate	灰Gray	303141			
	橙Orange	303142			
隔板Intermediate Plate	灰Gray	*			
跨接件Jumper		订货号Order NO.			
位数Poles No.		2 302302			
		3 302303			
		4 302304			
				
		9 302309			
		10 302310			
安全警告标记 Protective Warning Marker		订货号Order NO.			
		*			
正面标记和侧面标记Front And Side Marker		订货号Order NO.			
可提供印字服务Printing Service		316801			

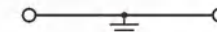
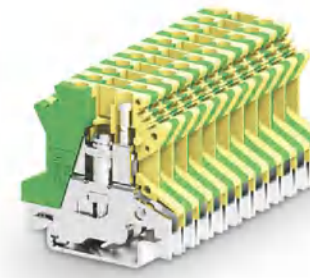

1.5mm² UK接地端子
UK Ground Terminal Block

技术参数Technical Parameter		
厚度Thickness	宽度Width	高度Height
6.1	42.9	41.85
IEC	UL	
*	*	
*	*	
刚性Solid	柔性Fine Stranded	带冷压头Furrule
0.2-4	0.2-2.5	0.25-2.5
30-12	30-12	30-12
	M3	
	0.6-0.8	
	V0	
	7-8	
订货信息Order Information		
订货号Order NO.		
302903		
*		
*		
配套附件Accessory		
订货号Order NO.		
*		
*		
*		
订货号Order NO.		
2 *		
3 *		
4 *		
... ..		
9 *		
10 *		
安全警告标记 Protective Warning Marker		
订货号Order NO.		
*		
正面标记和侧面标记Front And Side Marker		
订货号Order NO.		
306801		

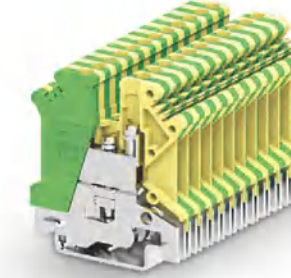

2.5mm² UK接地端子
UK Ground Terminal Block

技术参数Technical Parameter		
厚度Thickness	宽度Width	高度Height
5.1	42.9	47.25
IEC	UL	
*	*	
*	*	
刚性Solid	柔性Fine Stranded	带冷压头Furrule
0.2-4	0.2-2.5	0.2-2.5
28-12	28-12	28-12
	M3	
	0.6-0.8	
	V0	
	8-9	
订货信息Order Information		
订货号Order NO.		
303903		
*		
*		
配套附件Accessory		
订货号Order NO.		
*		
*		
302151		
订货号Order NO.		
2 *		
3 *		
4 *		
... ..		
9 *		
10 *		
安全警告标记 Protective Warning Marker		
订货号Order NO.		
*		
正面标记和侧面标记Front And Side Marker		
订货号Order NO.		
305801		

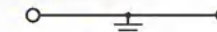
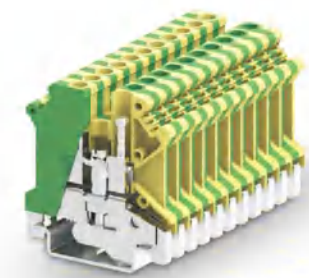

4mm² UK接地端子
UK Ground Terminal Block

技术参数Technical Parameter		
厚度Thickness	宽度Width	高度Height
6.1	42.9	47.2
IEC	UL	
*	*	
*	*	
刚性Solid	柔性Fine Stranded	带冷压头Furrule
0.2-6	0.2-4	0.25-2.5
30-10	30-10	30-10
	M3	
	0.6-0.8	
	V0	
	8-9	
订货信息Order Information		
订货号Order NO.		
305903		
*		
*		
配套附件Accessory		
订货号Order NO.		
*		
*		
302151		
订货号Order NO.		
2 *		
3 *		
4 *		
... ..		
9 *		
10 *		
安全警告标记 Protective Warning Marker		
订货号Order NO.		
*		
正面标记和侧面标记Front And Side Marker		
订货号Order NO.		
306801		

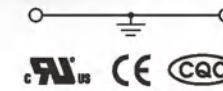
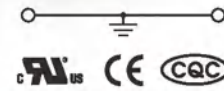
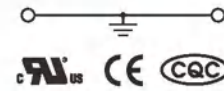
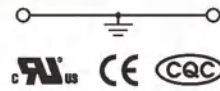
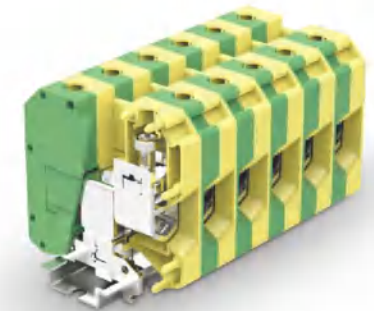
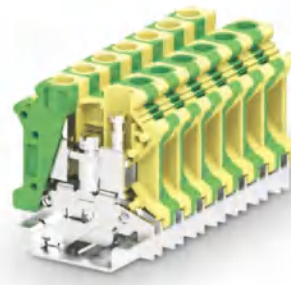
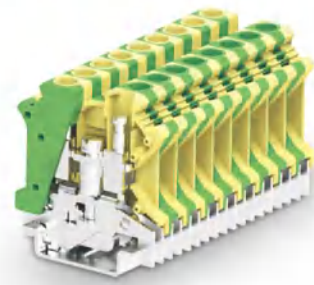

6mm² UK接地端子
UK Ground Terminal Block

10mm² UK接地端子
UK Ground Terminal Block

16mm² UK接地端子
UK Ground Terminal Block

35mm² UK接地端子
UK Ground Terminal Block

50mm² UK接地端子
UK Ground Terminal Block

尺寸Size	
注: 安装NS35/7.5导轨后的高度 Note: Height With DIN Rail NS 35/7.5	[mm]
额定参数Rated Parameters	
额定电压Rated Voltage	[V]
额定电流Rated Current	[A]
接线容量Wire Range	
	[mm ²]
	[AWG]
螺钉类型Screw Type	[*]
扭矩Torque	[N.m]
其余参数Other Parameters	
绝缘材料/阻燃等级, 符合UL94 Insulating Material / Flame Retardant Grade, Conforming To UL94	
剥线长度Strip length	[mm]

技术参数Technical Parameter		
厚度Thickness	宽度Width	高度Height
8.1	42.9	47.2
IEC	UL	
*	*	
*	*	
刚性Solid	柔性Fine Stranded	带冷压头Furrule
0.2-10	0.2-6	0.25-6
26-8	26-8	26-8
M4		
1.2-1.5		
V0		
10-11		

技术参数Technical Parameter		
厚度Thickness	宽度Width	高度Height
10.2	42.8	47.2
IEC	UL	
*	*	
*	*	
刚性Solid	柔性Fine Stranded	带冷压头Furrule
0.5-16	0.5-10	0.5-6
24-6	24-6	24-6
M4		
1.2-1.5		
V0		
10-11		

技术参数Technical Parameter		
厚度Thickness	宽度Width	高度Height
12	43	54.3
IEC	UL	
*	*	
*	*	
刚性Solid	柔性Fine Stranded	带冷压头Furrule
2.5-25	4-16	1.5-16
22-4	22-4	22-4
M4		
1.2-1.5		
V0		
11-12		

技术参数Technical Parameter		
厚度Thickness	宽度Width	高度Height
15	50.4	62.45
IEC	UL	
*	*	
*	*	
刚性Solid	柔性Fine Stranded	带冷压头Furrule
0.75-50	0.75-35	0.75-35
18-1/0	18-1/0	18-1/0
M6		
3.0-3.5		
V0		
15-16		

技术参数Technical Parameter		
厚度Thickness	宽度Width	高度Height
20	70.7	76.2
IEC	UL	
*	*	
*	*	
刚性Solid	柔性Fine Stranded	带冷压头Furrule
16-70	25-70	25-50
6-2/0	6-2/0	6-2/0
V0		

产品Product	
颜色Colour	黄绿Yellow green
适配NS 35/7.5导轨 Can Be Used For DIN Rail NS 35/7.5	*

订货信息Order Information	
订货号Order NO.	306903
	*
	*

订货信息Order Information	
订货号Order NO.	310903
	*
	*

订货信息Order Information	
订货号Order NO.	316903
	*
	*

订货信息Order Information	
订货号Order NO.	335903
	*
	*

订货信息Order Information	
订货号Order NO.	350903
	*
	*

配套附件Accessory	
端板Cover Plate	颜色Colour
端板Cover Plate	灰Gray
端板Cover Plate	橙Orange
隔板Intermediate Plate	灰Gray

配套附件Accessory	
订货号Order NO.	
	*
	*
302151	

配套附件Accessory	
订货号Order NO.	
	*
	*
302151	

配套附件Accessory	
订货号Order NO.	
	*
	*
302151	

配套附件Accessory	
订货号Order NO.	
	*
	*
302151	

配套附件Accessory	
订货号Order NO.	
	*
	*
	*

跨接件Jumper	
位数Poles No.	
2	*
3	*
4	*
...
9	*
10	*

跨接件Jumper	
订货号Order NO.	
	*
	*
	*

	*
	*

跨接件Jumper	
订货号Order NO.	
	*
	*
	*

	*
	*

跨接件Jumper	
订货号Order NO.	
	*
	*
	*

	*
	*

跨接件Jumper	
订货号Order NO.	
	*
	*
	*

	*
	*

跨接件Jumper	
订货号Order NO.	
	*
	*
	*

	*
	*

安全警告标记 Protective Warning Marker	
订货号Order NO.	306701

安全警告标记 Protective Warning Marker	
订货号Order NO.	310701

安全警告标记 Protective Warning Marker	
订货号Order NO.	316701

安全警告标记 Protective Warning Marker	
订货号Order NO.	335701

安全警告标记 Protective Warning Marker	
订货号Order NO.	350701

安全警告标记 Protective Warning Marker	
订货号Order NO.	310801

正面标记和侧面标记 Front And Side Marker	
可提供印字服务 Printing Service	308801

正面标记和侧面标记 Front And Side Marker	
可提供印字服务 Printing Service	310801

正面标记和侧面标记 Front And Side Marker	
可提供印字服务 Printing Service	310801

正面标记和侧面标记 Front And Side Marker	
可提供印字服务 Printing Service	310801

正面标记和侧面标记 Front And Side Marker	
可提供印字服务 Printing Service	310801

正面标记和侧面标记 Front And Side Marker	
可提供印字服务 Printing Service	310801

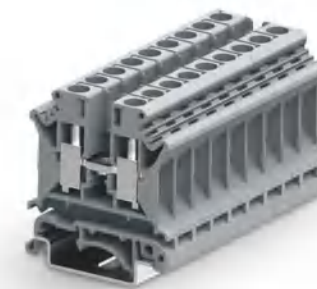
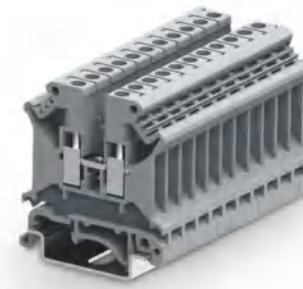
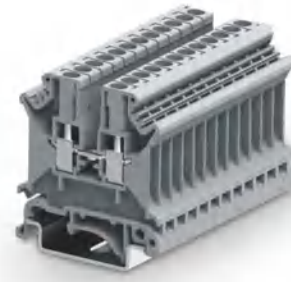

2.5mm² SUK接线端子
SUK Terminal Block

2.5mm² SUK接线端子
SUK Terminal Block

4mm² SUK接线端子
SUK Terminal Block

6mm² SUK接线端子
SUK Terminal Block

10mm² SUK接线端子
SUK Terminal Block

尺寸Size	
注: 安装NS35/7.5导轨后的高度 Note: Height With DIN Rail NS 35/7.5	[mm]
额定参数Rated Parameters	
额定电压Rated Voltage	[V]
额定电流Rated Current	[A]
接线容量Wire Range	
	[mm ²]
	[AWG]
螺钉类型Screw Type	[*]
扭矩Torque	[N.m]
其余参数Other Parameters	
绝缘材料/阻燃等级, 符合UL94 Insulating Material / Flame Retardant Grade, Conforming To UL94	
剥线长度Strip length	[mm]

技术参数Technical Parameter		
厚度Thickness	宽度Width	高度Height
6.1	42.2	42
IEC	UL	
800	300	
24	24	
刚性Solid	柔性Fine Stranded	带冷压头Furrule
0.2-4	0.2-2.5	0.25-2.5
30-12	30-12	30-12
M3		
0.6-0.8		
V0		
8-9		

技术参数Technical Parameter		
厚度Thickness	宽度Width	高度Height
5.1	42.2	46.8
IEC	UL	
800	600	
24	20	
刚性Solid	柔性Fine Stranded	带冷压头Furrule
0.2-4	0.2-2.5	0.2-2.5
28-12	28-12	28-12
M3		
0.6-0.8		
V0		
8-9		

技术参数Technical Parameter		
厚度Thickness	宽度Width	高度Height
6	42.2	46.8
IEC	UL	
800	600	
32	30	
刚性Solid	柔性Fine Stranded	带冷压头Furrule
0.2-6	0.2-4	0.25-4
30-10	30-10	30-10
M3		
0.6-0.8		
V0		
8-9		

技术参数Technical Parameter		
厚度Thickness	宽度Width	高度Height
8.1	42.2	46.8
IEC	UL	
800	600	
41	50	
刚性Solid	柔性Fine Stranded	带冷压头Furrule
0.2-10	0.2-6	0.25-6
26-8	26-8	26-8
M4		
1.2-1.5		
V0		
10-11		

技术参数Technical Parameter		
厚度Thickness	宽度Width	高度Height
10	42.2	46.8
IEC	UL	
800	600	
57	65	
刚性Solid	柔性Fine Stranded	带冷压头Furrule
1.5-16	1.5-10	1.5-6
16-6	16-6	16-6
M4		
1.2-1.5		
V0		
10-11		

产品Product		颜色Colour
适配NS 35/7.5导轨 Can Be Used For DIN Rail NS 35/7.5		灰Gray
		橙Orange
		蓝Blue
端板Cover Plate		颜色Colour
端板Cover Plate		灰Gray
		橙Orange
隔板Intermediate Plate		灰Gray
跨接件Jumper		
位数Poles No.		
2		
3		
4		
...		
9		
10		
安全警告标记 Protective Warning Marker		
正面标记和侧面标记Front And Side Marker		
可提供印字服务Printing Service		

订货信息Order Information	
订货号Order NO.	
302991	
302994	
302992	
配套附件Accessory	
订货号Order NO.	
302101	
302102	
*	
跨接件Jumper	
订货号Order NO.	
302302	
302303	
302304	
.....	
302309	
302310	
订货号Order NO.	
*	
订货号Order NO.	
306801	

订货信息Order Information	
订货号Order NO.	
303991	
303994	
303992	
配套附件Accessory	
订货号Order NO.	
303101	
303102	
302151	
跨接件Jumper	
订货号Order NO.	
303302	
303303	
303304	
.....	
303309	
303310	
订货号Order NO.	
*	
订货号Order NO.	
305801	

订货信息Order Information	
订货号Order NO.	
305991	
305994	
305992	
配套附件Accessory	
订货号Order NO.	
303101	
303102	
302151	
跨接件Jumper	
订货号Order NO.	
302302	
302303	
302304	
.....	
302309	
302310	
订货号Order NO.	
*	
订货号Order NO.	
306801	

订货信息Order Information	
订货号Order NO.	
306991	
306994	
306992	
配套附件Accessory	
订货号Order NO.	
303101	
303102	
302151	
跨接件Jumper	
订货号Order NO.	
306302	
306303	
306304	
.....	
306309	
306310	
订货号Order NO.	
*	
订货号Order NO.	
308801	

订货信息Order Information	
订货号Order NO.	
310991	
310994	
310992	
配套附件Accessory	
订货号Order NO.	
303101	
303102	
302151	
跨接件Jumper	
订货号Order NO.	
310302	
310303	
310304	
.....	
310309	
310310	
订货号Order NO.	
*	
订货号Order NO.	
310801	



16mm² SUK接线端子
SUK Terminal Block

35mm² SUK接线端子
SUK Terminal Block

尺寸Size	
注: 安装NS35/7.5导轨后的高度 Note: Height With DIN Rail NS 35/7.5	[mm]
额定参数Rated Parameters	
额定电压Rated Voltage	[V]
额定电流Rated Current	[A]
接线容量Wire Range	
	[mm ²]
	[AWG]
螺钉类型Screw Type	[*]
扭矩Torque	[N.m]
其余参数Other Parameters	
绝缘材料/阻燃等级, 符合UL94 Insulating Material / Flame Retardant Grade, Conforming To UL94	
剥线长度Strip length	[mm]

技术参数Technical Parameter		
厚度Thickness	宽度Width	高度Height
12.2	50.5	50.8
IEC		UL
800	600	
76	85	
刚性Solid	柔性Fine Stranded	带冷压头Furrule
6-16	6-16	6-16
10-4	10-4	10-4
M5		
2.0-2.5		
V0		
12-13		

技术参数Technical Parameter		
厚度Thickness	宽度Width	高度Height
16	53.5	62.5
IEC		UL
1000	600	
125	150	
刚性Solid	柔性Fine Stranded	带冷压头Furrule
10-35	10-35	10-35
8-1/0	8-1/0	8-1/0
M6		
3.0-3.5		
V0		
16-17		

产品Product		颜色Colour
适配NS 35/7.5导轨 Can Be Used For DIN Rail NS 35/7.5		灰Gray
		橙Orange
		蓝Blue

订货信息Order Information	
订货号Order NO.	
316991	
316994	
316992	

订货信息Order Information	
订货号Order NO.	
335991	
335994	
335992	

配套附件Accessory		颜色Colour
端板Cover Plate		灰Gray
端板Cover Plate		橙Orange
隔板Intermediate Plate		灰Gray

配套附件Accessory	
订货号Order NO.	
*	
*	
302151	

配套附件Accessory	
订货号Order NO.	
*	
*	
302151	

跨接件Jumper	
位数Poles No.	
2	
3	
4	
...	
9	
10	

跨接件Jumper	
订货号Order NO.	
316302	
316303	
316304	
.....	
316309	
316310	

跨接件Jumper	
位数Poles No.	
2	
3	
4	
...	
9	
10	

安全警告标记 Protective Warning Marker	
正面标记和侧面标记Front And Side Marker 可提供印字服务Printing Service	

安全警告标记 Protective Warning Marker	
订货号Order NO.	
316701	
310801	

安全警告标记 Protective Warning Marker	
订货号Order NO.	
*	
310801	

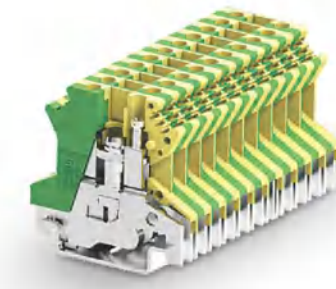

2.5mm² SUK接地端子
SUK Ground Terminal Block

2.5mm² SUK接地端子
SUK Ground Terminal Block

尺寸Size	
注: 安装NS35/7.5导轨后的高度 Note: Height With DIN Rail NS 35/7.5	[mm]
额定参数Rated Parameters	
额定电压Rated Voltage	[V]
额定电流Rated Current	[A]
接线容量Wire Range	
	[mm ²]
	[AWG]
螺钉类型Screw Type	[*]
扭矩Torque	[N.m]
其余参数Other Parameters	
绝缘材料/阻燃等级, 符合UL94 Insulating Material / Flame Retardant Grade, Conforming To UL94	
剥线长度Strip length	[mm]

技术参数Technical Parameter		
厚度Thickness	宽度Width	高度Height
6.1	42.9	41.85
IEC		UL
*	*	
*	*	
刚性Solid	柔性Fine Stranded	带冷压头Furrule
0.2-4	0.2-2.5	0.25-2.5
30-12	30-12	30-12
M3		
0.6-0.8		
V0		
7-8		

技术参数Technical Parameter		
厚度Thickness	宽度Width	高度Height
5.1	42.9	47.25
IEC		UL
*	*	
*	*	
刚性Solid	柔性Fine Stranded	带冷压头Furrule
0.2-4	0.2-2.5	0.25-2.5
28-12	28-12	28-12
M3		
0.6-0.8		
V0		
8-9		

产品Product		颜色Colour
适配NS 35/7.5导轨 Can Be Used For DIN Rail NS 35/7.5		黄绿Yellow green
		*
		*

订货信息Order Information	
订货号Order NO.	
302993	
*	
*	

订货信息Order Information	
订货号Order NO.	
303993	
*	
*	

配套附件Accessory		颜色Colour
端板Cover Plate		灰Gray
端板Cover Plate		橙Orange
隔板Intermediate Plate		灰Gray

配套附件Accessory	
订货号Order NO.	
*	
*	
*	

配套附件Accessory	
订货号Order NO.	
*	
*	
302151	

跨接件Jumper	
位数Poles No.	
2	
3	
4	
...	
9	
10	

跨接件Jumper	
订货号Order NO.	
*	
*	
*	
.....	
*	
*	

跨接件Jumper	
订货号Order NO.	
*	
*	
*	
.....	
*	
*	

安全警告标记 Protective Warning Marker	
正面标记和侧面标记Front And Side Marker 可提供印字服务Printing Service	

安全警告标记 Protective Warning Marker	
订货号Order NO.	
310801	

安全警告标记 Protective Warning Marker	
订货号Order NO.	
310801	

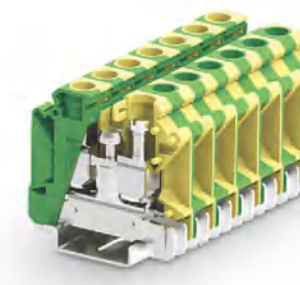
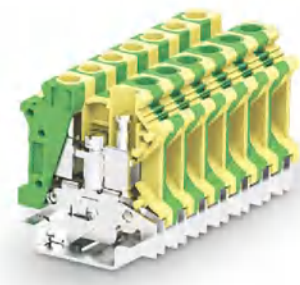
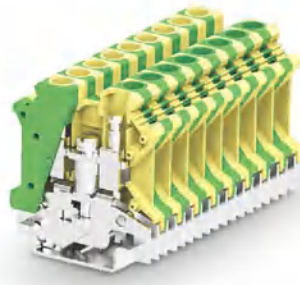
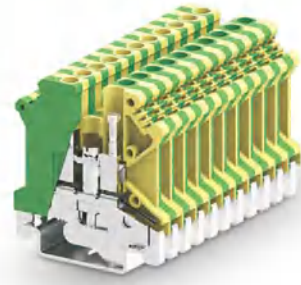

4mm² SUK接地端子
SUK Ground Terminal Block

6mm² SUK接地端子
SUK Ground Terminal Block

10mm² SUK接地端子
SUK Ground Terminal Block

16mm² SUK接地端子
SUK Ground Terminal Block

35mm² SUK接地端子
SUK Ground Terminal Block

尺寸Size	
注: 安装NS35/7.5导轨后的高度 Note: Height With DIN Rail NS 35/7.5	[mm]
额定参数Rated Parameters	
额定电压Rated Voltage	[V]
额定电流Rated Current	[A]
接线容量Wire Range	
	[mm ²]
	[AWG]
螺钉类型Screw Type	[*]
扭矩Torque	[N.m]
其余参数Other Parameters	
绝缘材料/阻燃等级, 符合UL94 Insulating Material / Flame Retardant Grade, Conforming To UL94	
剥线长度Strip length	[mm]

技术参数Technical Parameter		
厚度Thickness	宽度Width	高度Height
6.1	42.9	47.2
IEC		
*	*	*
UL		
*	*	*
刚性Solid	柔性Fine Stranded	带冷压头Furrule
0.2-6	0.2-4	0.25-2.5
30-10	30-10	30-10
M3		
0.6-0.8		
V0		
8-9		

技术参数Technical Parameter		
厚度Thickness	宽度Width	高度Height
8.1	42.9	47.2
IEC		
*	*	*
UL		
*	*	*
刚性Solid	柔性Fine Stranded	带冷压头Furrule
0.2-10	0.2-6	0.25-6
26-8	26-8	26-8
M4		
1.2-1.5		
V0		
10-11		

技术参数Technical Parameter		
厚度Thickness	宽度Width	高度Height
10.2	42.8	47.2
IEC		
*	*	*
UL		
*	*	*
刚性Solid	柔性Fine Stranded	带冷压头Furrule
0.2-16	0.2-10	0.5-6
16-6	16-6	16-6
M4		
1.2-1.5		
V0		
10-11		

技术参数Technical Parameter		
厚度Thickness	宽度Width	高度Height
12.2	50.5	50.3
IEC		
*	*	*
UL		
*	*	*
刚性Solid	柔性Fine Stranded	带冷压头Furrule
0.2-25	0.2-16	0.5-16
10-4	10-4	10-4
M5		
2.0-2.5		
V0		
12-13		

技术参数Technical Parameter		
厚度Thickness	宽度Width	高度Height
16	53.2	62.2
IEC		
*	*	*
UL		
*	*	*
刚性Solid	柔性Fine Stranded	带冷压头Furrule
0.5-35	0.5-35	0.75-35
8-1/0	8-1/0	18-1/0
M6		
3.0-3.5		
V0		
16-17		

产品Product	
颜色Colour	黄绿色Yellow green
适配NS 35/7.5导轨 Can Be Used For DIN Rail NS 35/7.5	*

订货信息Order Information	
订货号Order NO.	305993
	*
	*

订货信息Order Information	
订货号Order NO.	306993
	*
	*

订货信息Order Information	
订货号Order NO.	310993
	*
	*

订货信息Order Information	
订货号Order NO.	316993
	*
	*

订货信息Order Information	
订货号Order NO.	335993
	*
	*

端板Cover Plate	
颜色Colour	灰Gray
	橙Orange
隔板Intermediate Plate	灰Gray

配套附件Accessory	
订货号Order NO.	302151
	*
	*

配套附件Accessory	
订货号Order NO.	302151
	*
	*

配套附件Accessory	
订货号Order NO.	302151
	*
	*

配套附件Accessory	
订货号Order NO.	302151
	*
	*

配套附件Accessory	
订货号Order NO.	302151
	*
	*

跨接件Jumper	
位数Poles No.	2
	3
	4
	...
	9
	10

跨接件Jumper	
订货号Order NO.	*
	*
	*

	*
	*

跨接件Jumper	
订货号Order NO.	*
	*
	*

	*
	*

跨接件Jumper	
订货号Order NO.	*
	*
	*

	*
	*

跨接件Jumper	
订货号Order NO.	*
	*
	*

	*
	*

跨接件Jumper	
订货号Order NO.	*
	*
	*

	*
	*

安全警告标记 Protective Warning Marker	
订货号Order NO.	*

安全警告标记 Protective Warning Marker	
订货号Order NO.	306701

安全警告标记 Protective Warning Marker	
订货号Order NO.	306701

安全警告标记 Protective Warning Marker	
订货号Order NO.	310701

安全警告标记 Protective Warning Marker	
订货号Order NO.	316701

安全警告标记 Protective Warning Marker	
订货号Order NO.	*

正面标记和侧面标记Front And Side Marker	
可提供印字服务Printing Service	306801

正面标记和侧面标记Front And Side Marker	
订货号Order NO.	306801

正面标记和侧面标记Front And Side Marker	
订货号Order NO.	308801

正面标记和侧面标记Front And Side Marker	
订货号Order NO.	310801

正面标记和侧面标记Front And Side Marker	
订货号Order NO.	310801

正面标记和侧面标记Front And Side Marker	
订货号Order NO.	310801

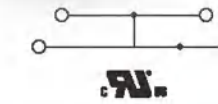
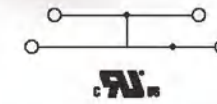
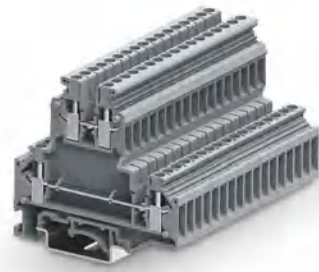

2.5mm² UKD接线端子
UKD Double Deck Terminal Block

4mm² UKD接线端子
UKD Double Deck Terminal Block

4mm² UKD上下导通接线端子
UKD Double Deck Terminal Block

10mm² UKD接线端子
UKD Double Deck Terminal Block

10mm² UKD上下导通接线端子
UKD Double Deck Terminal Block

尺寸Size	
注: 安装NS35/7.5导轨后的高度 Note: Height With DIN Rail NS 35/7.5	[mm]
额定参数Rated Parameters	
额定电压Rated Voltage	[V]
额定电流Rated Current	[A]
接线容量Wire Range	
	[mm ²]
	[AWG]
螺钉类型Screw Type	[*]
扭矩Torque	[N.m]
其余参数Other Parameters	
绝缘材料/阻燃等级, 符合UL94 Insulating Material / Flame Retardant Grade, Conforming To UL94	
剥线长度Strip length	[mm]

技术参数Technical Parameter		
厚度Thickness	宽度Width	高度Height
5.2	67.2	62.2
IEC	UL	
500	600	
24	20	
刚性Solid	柔性Fine Stranded	带冷压头Furrule
0.2-4	0.2-2.5	0.2-2.5
28-12	28-12	28-12
M3		
0.6-0.8		
V0		
8-9		

技术参数Technical Parameter		
厚度Thickness	宽度Width	高度Height
6.2	67.2	62.2
IEC	UL	
500	600	
32	30	
刚性Solid	柔性Fine Stranded	带冷压头Furrule
0.2-4	0.2-4	0.25-4
26-10	26-10	26-10
M3		
0.6-0.8		
V0		
8-9		

技术参数Technical Parameter		
厚度Thickness	宽度Width	高度Height
6.2	67.2	62.2
IEC	UL	
500	600	
32	30	
刚性Solid	柔性Fine Stranded	带冷压头Furrule
0.2-4	0.2-4	0.25-4
26-10	26-10	26-10
M3		
0.6-0.8		
V0		
8-9		

技术参数Technical Parameter		
厚度Thickness	宽度Width	高度Height
10.2	77.5	73
IEC	UL	
500	600	
57	65	
刚性Solid	柔性Fine Stranded	带冷压头Furrule
0.5-10	0.5-10	0.5-10
24-6	24-6	24-6
M4		
1.2-1.5		
V0		
11-12		

技术参数Technical Parameter		
厚度Thickness	宽度Width	高度Height
10.2	77.5	73
IEC	UL	
500	600	
57	65	
刚性Solid	柔性Fine Stranded	带冷压头Furrule
0.5-10	0.5-10	0.5-10
24-6	24-6	24-6
M4		
1.2-1.5		
V0		
11-12		

订货信息Order Information

订货信息Order Information

订货信息Order Information

订货信息Order Information

订货信息Order Information

订货信息Order Information

产品Product	颜色Colour
适配NS 35/7.5导轨 Can Be Used For DIN Rail NS 35/7.5	灰Gray
	蓝Blue

订货号Order NO.
303921
303922

订货号Order NO.
305921
305922

订货号Order NO.
305921-PV
*

订货号Order NO.
310921
*

订货号Order NO.
310921-PV
*

配套附件Accessory

配套附件Accessory

配套附件Accessory

配套附件Accessory

配套附件Accessory

配套附件Accessory

端板Cover Plate	颜色Colour
端板Cover Plate	灰Gray
	橙Orange
隔板Intermediate Plate	灰Gray
补偿盖板 Compensatory Cover Plate	灰Gray

订货号Order NO.
303121
*
*
305121

订货号Order NO.
303121
*
*
305121

订货号Order NO.
303121
*
*
302151

订货号Order NO.
310121
*
*
*

订货号Order NO.
310121
*
*
*

跨接件Jumper

跨接件Jumper

跨接件Jumper

跨接件Jumper

跨接件Jumper

跨接件Jumper

位数Poles No.
2
3
4
...
9
10

订货号Order NO.
303302
303303
303304
.....
303309
303310

订货号Order NO.
302302
302303
302304
.....
302309
302310

订货号Order NO.
302302
302303
302304
.....
302309
302310

订货号Order NO.
310302
310303
310304
.....
310309
310310

订货号Order NO.
310302
310303
310304
.....
310309
310310

安全警告标记
Protective Warning Marker

安全警告标记
Protective Warning Marker

安全警告标记
Protective Warning Marker

安全警告标记
Protective Warning Marker

安全警告标记
Protective Warning Marker

安全警告标记
Protective Warning Marker

正面标记和侧面标记 Front And Side Marker
可提供印字服务 Printing Service

订货号Order NO.
*
305801

订货号Order NO.
*
306801

订货号Order NO.
*
306801

订货号Order NO.
*
310801

订货号Order NO.
*
310801

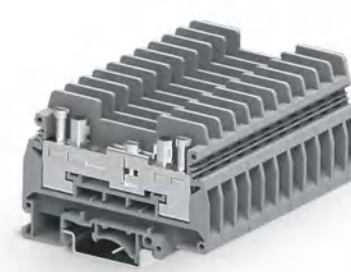
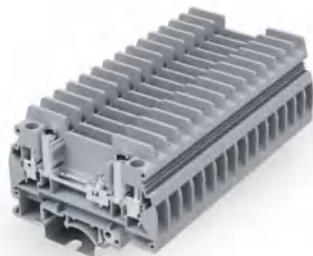
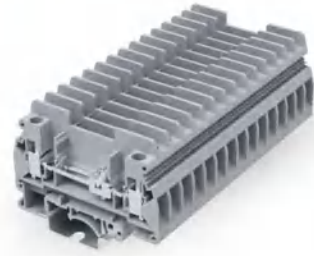

尺寸Size	
注: 安装NS35/7.5导轨后的高度 Note: Height With DIN Rail NS 35/7.5	[mm]
额定参数Rated Parameters	
额定电压Rated Voltage	[V]
额定电流Rated Current	[A]
接线容量Wire Range	
	[mm ²]
	[AWG]
螺钉类型Screw Type	[*]
扭矩Torque	[N.m]
其余参数Other Parameters	
绝缘材料/阻燃等级, 符合UL94 Insulating Material / Flame Retardant Grade, Conforming To UL94	
剥线长度Strip length	[mm]
产品Product	
颜色Colour	
适配NS 35/7.5导轨 Can Be Used For DIN Rail NS 35/7.5	灰Gray 蓝Blue
端板Cover Plate	
颜色Colour	
端板Cover Plate	灰Gray 橙Orange
隔板Intermediate Plate	灰Gray
补偿盖板 Compensatory Cover Plate	灰Gray
跨接件Jumper	
位数Poles No.	
2	
3	
4	
...	
9	
10	
安全警告标记 Protective Warning Marker	
正面标记和侧面标记Front And Side Marker 可提供印字服务Printing Service	

6mm ² 普通分断测试连接器 General test terminal block		
技术参数Technical Parameter		
厚度Thickness	宽度Width	高度Height
8.2	72.4	50.6
IEC	UL	
630	300	
41	50	
刚性Solid	柔性Fine Stranded	带冷压头Ferrule
0.5-10	0.5-6	0.5-6
26-8	26-8	26-8
M4		
1.2-1.6		
V0		
13-14		

订货信息Order Information	
订货号Order NO.	SUK6-T-GY *
配套附件Accessory	
订货号Order NO.	306101 * 306151 *
跨接件Jumper	
订货号Order NO.	306322 306320
安全警告标记 Protective Warning Marker	
订货号Order NO.	* 308801
正面标记和侧面标记Front And Side Marker 可提供印字服务Printing Service	
订货号Order NO.	308801

6mm ² 带导电柱分断测试连接器 Test terminal block with conductive column		
技术参数Technical Parameter		
厚度Thickness	宽度Width	高度Height
8.2	72.4	50.6
IEC	UL	
630	300	
41	50	
刚性Solid	柔性Fine Stranded	带冷压头Ferrule
0.5-10	0.5-6	0.5-6
26-8	26-8	26-8
M4		
1.2-1.6		
V0		
13-14		

订货信息Order Information	
订货号Order NO.	SUK6-T-JP-GY *
配套附件Accessory	
订货号Order NO.	306101 * 306151 *
跨接件Jumper	
订货号Order NO.	306322 306320
安全警告标记 Protective Warning Marker	
订货号Order NO.	* 308801
正面标记和侧面标记Front And Side Marker 可提供印字服务Printing Service	
订货号Order NO.	308801

6mm ² URTK/S分断测试端子 URTK/S General Test Terminal Block		
技术参数Technical Parameter		
厚度Thickness	宽度Width	高度Height
8.2	72.4	51.7
IEC	UL	
400	300	
41	50	
刚性Solid	柔性Fine Stranded	带冷压头Ferrule
0.5-10	0.5-6	0.5-4
26-8	26-8	26-8
M4		
1.2-1.5		
V0		
13-14		

订货信息Order Information	
订货号Order NO.	306911 *
配套附件Accessory	
订货号Order NO.	306101 * 306151 *
跨接件Jumper	
订货号Order NO.	306322 306320
安全警告标记 Protective Warning Marker	
订货号Order NO.	* 308801
正面标记和侧面标记Front And Side Marker 可提供印字服务Printing Service	
订货号Order NO.	308801

4mm ² UK5/HESI(带保险管) UK5/HESI Terminal Block With Fuse		
技术参数Technical Parameter		
厚度Thickness	宽度Width	高度Height
8	72.6	50.4
IEC	UL	
500	600	
6.3	12	
刚性Solid	柔性Fine Stranded	带冷压头Ferrule
0.2-4	0.2-4	0.25-4
26-10	26-10	26-10
M3		
0.6-0.8		
V0		
8-9		

订货信息Order Information	
订货号Order NO.	灰Gray 305972 黑Black 305971
配套附件Accessory	
订货号Order NO.	* * *
跨接件Jumper	
订货号Order NO.	* * * * *
安全警告标记 Protective Warning Marker	
订货号Order NO.	* 308801
正面标记和侧面标记Front And Side Marker 可提供印字服务Printing Service	
订货号Order NO.	308801

TB系列微型弹簧接线端子

TB Rail-mounted Terminal Blocks With Spring-cage Clamp

TB系列微型弹簧接线端子采用笼式弹簧接线技术，产品精巧，拼装灵活。能够满足客户更加苛刻的使用空间要求。提供了螺钉固定、销钉固定、小导轨卡接固定、大导轨卡接固定和组合固定等多种固定方式，便于客户将产品固定在各种各样的使用空间中。产品设计制造符合IEC/EN60947、UL1059等国际标准，并通过TUV、CE、CQC、UL、CB认证。

TB series rail-mounted spring cage clamp terminal blocks use spring cage connection technology. The product is compact and can be flexible assembled. Can meet customer requirement for the space saving, fixing ways can be with screws, with snap-in mounting feet, on small Din rail, on big Din rail or certain combination ways. Product design and manufacturing is in line with the international standard IEC60947, UL1059, UL486E. and have the certificates CQC, UL, VDE, CE, ROHS etc.

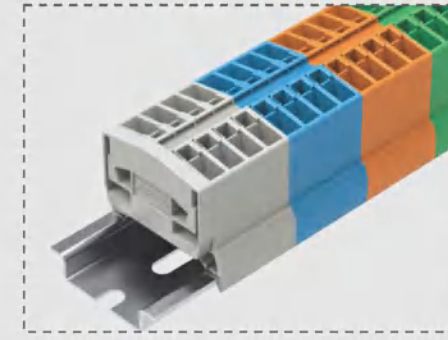
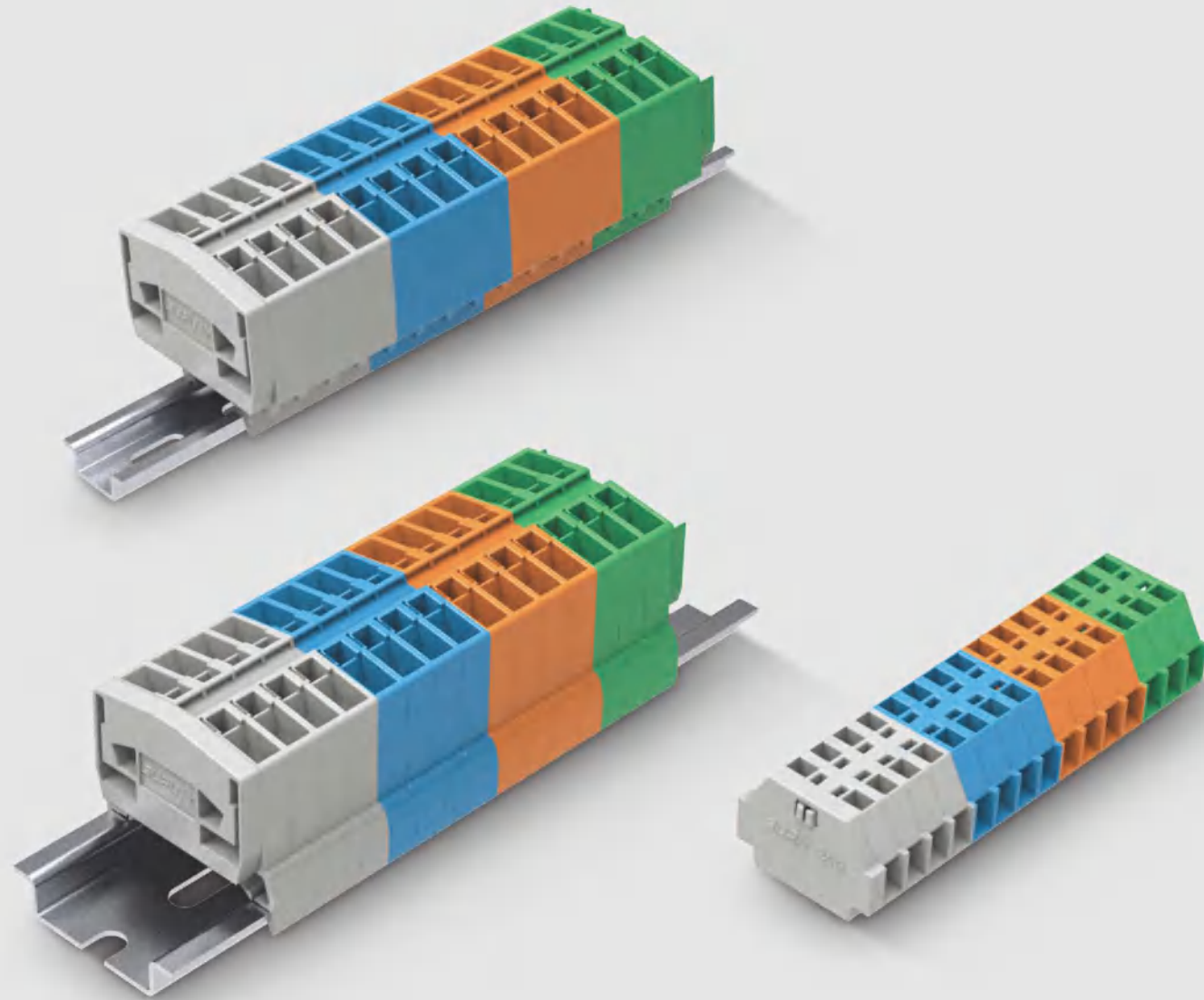

小型化 Miniaturization

- ▲ 小型的体积满足客户的特殊需求，可适用于小型电机和小电源的接线、布线
- ▲ The compacted space can reach customers' special demand, especially used for mini motor, low current wire connections.

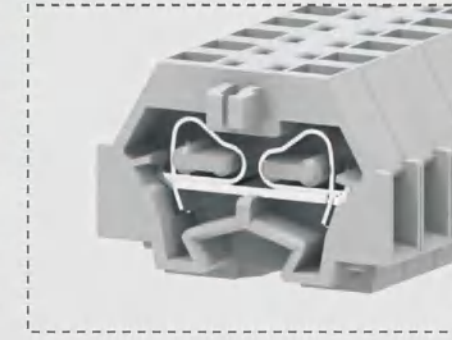

连接方式 Connection Method

- ▲ 通过榫头接合相互卡接形成端子条
- ▲ By section and slot, the terminal blocks can be formed into decked.



接线 Wiring

- ▲ 具有一进一出和两进两出两种接线方式
- ▲ 1-1 or 2-2 feed through connection option.

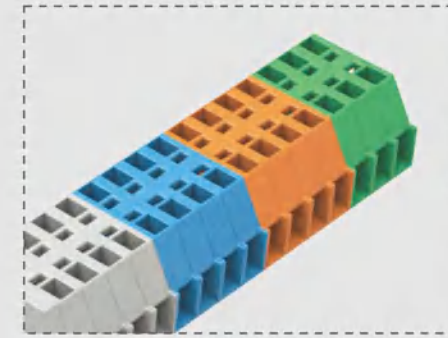

颜色 Color

- ▲ 具有多种颜色可供选择，满足多样化的线路布线
- ▲ Different colors are optional for customers' special requirements.

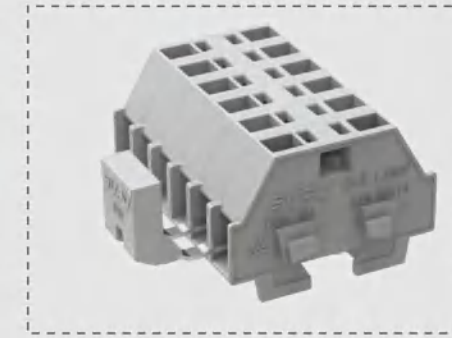

跨接系统 Jumper System

- ▲ 相邻跨接桥可桥接相邻的端子
- ▲ Jumper can get the adjacent terminal blocks connected.



导轨 DIN Rail

- ▲ 拥有两种规格卡脚，可安装至TS15或TS35两种导轨上
- ▲ 2 kinds of fixing feet where can connect to the TS15 or TS35 din rail.



按键 Press Button

- ▲ 按键可以直接方便导线的安装
- ▲ It's easy to connect the wires by press buttons.

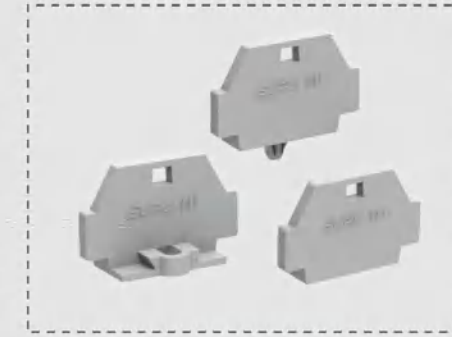

盖板 End and Intermediate Plate

- ▲ 具有带固定器、带销钉多种固定方式的盖板
- ▲ The plate can have fixing flanges or snap-in mounting feet.



固定支架 Fixed Support

- ▲ 可将端子通过固定支架安装到导轨上
- ▲ The terminal blocks can be assembled to din rails through fixed support.

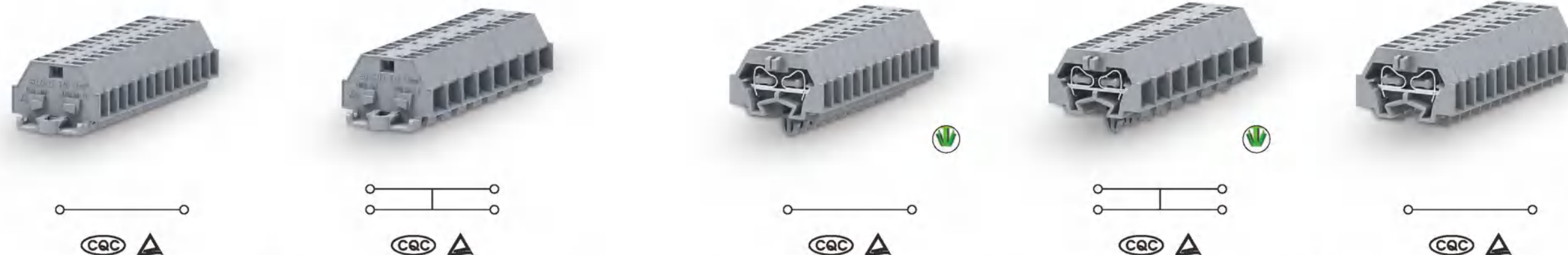

240系列一进一出带固定器侧面接线端子
240 Series 1-1 Feed Through Terminal Block With Fixing Flanges of Side-entry

240系列两进两出带固定器侧面接线端子
240 Series 2-2 Feed Through Terminal Block With Fixing Flanges of Side-entry

240系列一进一出带销钉侧面接线端子
240 Series 1-1 Feed Through Terminal Block With Snap-in Mounting Feet of Side-entry

240系列两进两出带销钉侧面接线端子
240 Series 2-2 Feed Through Terminal Block With Snap-in Mounting Feet of Side-entry

240系列一进一出侧面接线终端用端子
240 Series 1-1 Feed Through End Terminal Block With Snap-in Mounting Feet of Side-entry

		技术参数Technical Parameter			技术参数Technical Parameter			技术参数Technical Parameter			技术参数Technical Parameter			技术参数Technical Parameter		
尺寸Size		厚度Thickness	宽度Width	高度Height	厚度Thickness	宽度Width	高度Height	厚度Thickness	宽度Width	高度Height	厚度Thickness	宽度Width	高度Height	厚度Thickness	宽度Width	高度Height
[mm]		5	25.1	17.2	8	25.1	17.2	5	25.1	17.2	8	25.1	17.2	5	25.1	17.2
额定参数Rated Parameters		IEC	UL		IEC	UL		IEC	UL		IEC	UL		IEC	UL	
额定电压Rated Voltage [V]		400	300		400	300		400	300		400	300		400	300	
额定电流Rated Current [A]		18	10		18	10		18	10		18	10		18	10	
接线容量Wire Range		刚性Solid	柔性Fine Stranded	带冷压头Furrule	刚性Solid	柔性Fine Stranded	带冷压头Furrule	刚性Solid	柔性Fine Stranded	带冷压头Furrule	刚性Solid	柔性Fine Stranded	带冷压头Furrule	刚性Solid	柔性Fine Stranded	带冷压头Furrule
[mm ²]		0.2-1.5	0.2-1.5	0.2-1	0.2-1.5	0.2-1.5	0.2-1	0.2-1.5	0.2-1.5	0.2-1	0.2-1.5	0.2-1.5	0.2-1	0.2-1.5	0.2-1.5	0.2-1
[AWG]		28-16	28-16	28-16	28-16	28-16	28-16	28-16	28-16	28-16	28-16	28-16	28-16	28-16	28-16	28-16
其余参数Other Parameters																
绝缘材料/阻燃等级, 符合UL94 Insulating Material / Flame Retardant Grade, Conforming To UL94		V0			V0			V0			V0			V0		
剥线长度Strip length [mm]		8-9			8-9			8-9			8-9			8-9		
产品Product		订货信息Order Information			订货信息Order Information			订货信息Order Information			订货信息Order Information			订货信息Order Information		
颜色Colour		订货号Order NO.			订货号Order NO.			订货号Order NO.			订货号Order NO.			订货号Order NO.		
灰Gray		240301			240331			240311			240341			240321		
橙Orange		240302			240332			240312			240342			240322		
白灰Light gray		240303			240333			240313			240343			240323		
适配NS 35/7.5导轨 Can Be Used For DIN Rail NS 35/7.5		240304			240334			240314			240344			240324		
蓝Blue		240305			240335			240315			240345			240325		
黄Yellow		240306			240336			240316			240346			240326		
绿Green		240307			240337			240317			240347			240327		
黄绿Yellow green		240309			240339			240319			240349			240329		
粉Pink																
端板Cover Plate		配套附件Accessory			配套附件Accessory			配套附件Accessory			配套附件Accessory			配套附件Accessory		
平板Plate		订货号Order NO.			订货号Order NO.			订货号Order NO.			订货号Order NO.			订货号Order NO.		
灰Gray		*			*			240641			240641			240641		
橙Orange		*			*			240642			240642			240642		
带固定器With Fixing Flanges		240621			240621			*			*			*		
灰Gray		240622			240622			*			*			*		
带销钉With Snap-in Mounting Feet		*			*			240631			240631			240631		
灰Gray		*			*			240632			240632			240632		
橙Orange		*			*			*			*			*		
按键Press Button		*			*			*			*			*		
白White		241019			241019			241019			241019			241019		
固定支架Fixed Support		灰Gray			灰Gray			灰Gray			灰Gray			灰Gray		
跨接件Jumper		订货号Order NO.			订货号Order NO.			订货号Order NO.			订货号Order NO.			订货号Order NO.		
位数Poles No.		240601			240601			240601			240601			240601		
灰Gray		240601			240601			240601			240601			240601		

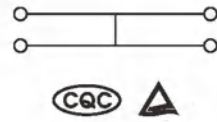
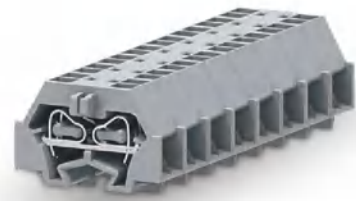

240系列两进两出侧面接线终端用端子
240 Series 2-2 Feed Through End Terminal Block
With Snap-in Mounting Feet of Side-entry

尺寸Size		技术参数Technical Parameter		
[mm]		厚度Thickness	宽度Width	高度Height
		8	25.1	17.2
额定参数Rated Parameters		IEC	UL	
额定电压Rated Voltage	[V]	400	300	
额定电流Rated Current	[A]	18	10	
接线容量Wire Range		刚性Solid	柔性Fine Stranded	带冷压头Furrule
[mm ²]		0.2-1.5	0.2-1.5	0.2-1
[AWG]		28-16	28-16	28-16
其余参数Other Parameters				
绝缘材料/阻燃等级, 符合UL94 Insulating Material / Flame Retardant Grade, Conforming To UL94		V0		
剥线长度Strip length	[mm]	8-9		
产品Product		订货信息Order Information		
颜色Colour		订货号Order NO.		
灰Gray		240351		
橙Orange		240352		
白灰Light gray		240353		
蓝Blue		240354		
黄Yellow		240355		
绿Green		240356		
黄绿Yellow green		240357		
粉Pink		240359		
适配NS 35/7.5导轨 Can Be Used For DIN Rail NS 35/7.5				
端板Cover Plate		配套附件Accessory		
订货号Order NO.		订货号Order NO.		
平板Plate	灰Gray	240641		
	橙Orange	240642		
带固定器With Fixing Flanges	灰Gray	*		
	橙Orange	*		
带销钉 With Snap-in Mounting Feet	灰Gray	240631		
	橙Orange	240632		
按键Press Button	白White	*		
固定支架Fixed Support	灰Gray	241019		
跨接件Jumper				
位数Poles No.	颜色Colour	订货号Order NO.		
2	灰Gray	240601		

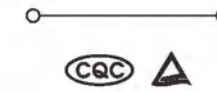

241系列一进一出带固定器侧面接线端子
241 Series 1-1 Feed Through Terminal Block
With Fixing Flanges of Side-entry

尺寸Size		技术参数Technical Parameter		
[mm]		厚度Thickness	宽度Width	高度Height
		6	28.1	18
额定参数Rated Parameters		IEC	UL	
额定电压Rated Voltage	[V]	500	300	
额定电流Rated Current	[A]	24	15	
接线容量Wire Range		刚性Solid	柔性Fine Stranded	带冷压头Furrule
[mm ²]		0.2-2.5	0.2-2.5	0.2-1.5
[AWG]		28-14	28-14	28-14
其余参数Other Parameters				
绝缘材料/阻燃等级, 符合UL94 Insulating Material / Flame Retardant Grade, Conforming To UL94		V0		
剥线长度Strip length	[mm]	8-9		
产品Product		订货信息Order Information		
颜色Colour		订货号Order NO.		
灰Gray		241301		
橙Orange		241302		
白灰Light gray		241303		
蓝Blue		241304		
黄Yellow		241305		
绿Green		241306		
黄绿Yellow green		241307		
粉Pink		241309		
适配NS 35/7.5导轨 Can Be Used For DIN Rail NS 35/7.5				
端板Cover Plate		配套附件Accessory		
订货号Order NO.		订货号Order NO.		
平板Plate	灰Gray	*		
	橙Orange	*		
带固定器With Fixing Flanges	灰Gray	241621		
	橙Orange	241622		
带销钉 With Snap-in Mounting Feet	灰Gray	*		
	橙Orange	*		
按键Press Button	白White	241221		
固定支架Fixed Support	灰Gray	241019		
跨接件Jumper				
位数Poles No.	颜色Colour	订货号Order NO.		
2	灰Gray	241601		

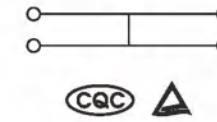
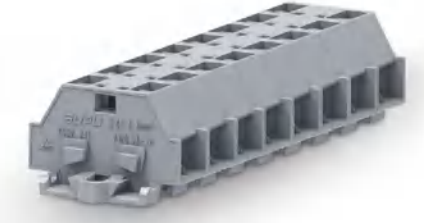

241系列两进两出带固定器侧面接线端子
241 Series 2-2 Feed Through Terminal Block
With Fixing Flanges of Side-entry

尺寸Size		技术参数Technical Parameter		
[mm]		厚度Thickness	宽度Width	高度Height
		10	28.1	18
额定参数Rated Parameters		IEC	UL	
额定电压Rated Voltage	[V]	500	300	
额定电流Rated Current	[A]	24	15	
接线容量Wire Range		刚性Solid	柔性Fine Stranded	带冷压头Furrule
[mm ²]		0.2-2.5	0.2-2.5	0.2-1.5
[AWG]		28-14	28-14	28-14
其余参数Other Parameters				
绝缘材料/阻燃等级, 符合UL94 Insulating Material / Flame Retardant Grade, Conforming To UL94		V0		
剥线长度Strip length	[mm]	8-9		
产品Product		订货信息Order Information		
颜色Colour		订货号Order NO.		
灰Gray		241331		
橙Orange		241332		
白灰Light gray		241333		
蓝Blue		241334		
黄Yellow		241335		
绿Green		241336		
黄绿Yellow green		241337		
粉Pink		241309		
适配NS 35/7.5导轨 Can Be Used For DIN Rail NS 35/7.5				
端板Cover Plate		配套附件Accessory		
订货号Order NO.		订货号Order NO.		
平板Plate	灰Gray	*		
	橙Orange	*		
带固定器With Fixing Flanges	灰Gray	241621		
	橙Orange	241622		
带销钉 With Snap-in Mounting Feet	灰Gray	*		
	橙Orange	*		
按键Press Button	白White	241221		
固定支架Fixed Support	灰Gray	241019		
跨接件Jumper				
位数Poles No.	颜色Colour	订货号Order NO.		
2	灰Gray	241601		

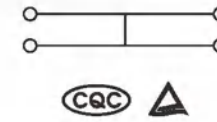
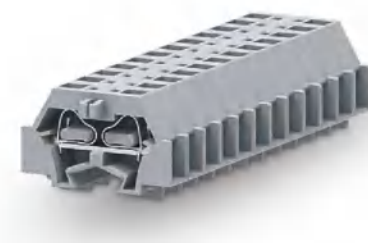
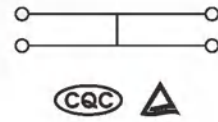
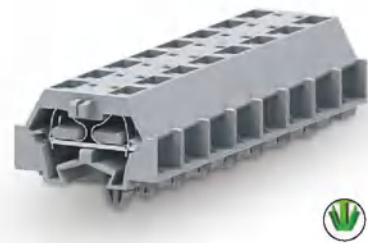
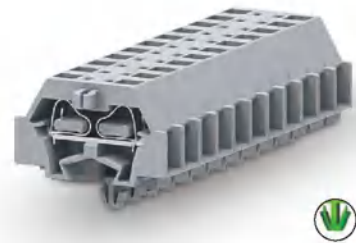

241系列一进一出带销钉侧面接线端子
241 Series 1-1 Feed Through Terminal Block
With Snap-in Mounting Feet of Side-entry

241系列两进两出带销钉侧面接线端子
241 Series 2-2 Feed Through Terminal Block
With Snap-in Mounting Feet of Side-entry

241系列一进一出侧面接线终端用端子
241 Series 1-1 Feed Through End Terminal Block
With Snap-in Mounting Feet of Side-entry

241系列两进两出侧面接线终端用端子
241 Series 2-2 Feed Through End Terminal Block
With Snap-in Mounting Feet of Side-entry

尺寸Size	
[mm]	
额定参数Rated Parameters	
额定电压Rated Voltage	[V]
额定电流Rated Current	[A]
接线容量Wire Range	
[mm ²]	
[AWG]	
其余参数Other Parameters	
绝缘材料/阻燃等级, 符合UL94 Insulating Material / Flame Retardant Grade, Conforming To UL94	
剥线长度Strip length	[mm]
产品Product	
颜色Colour	
灰Gray	
橙Orange	
白灰Light gray	
蓝Blue	
黄Yellow	
绿Green	
黄绿Yellow green	
粉Pink	
适配NS 35/7.5导轨 Can Be Used For DIN Rail NS 35/7.5	
端板Cover Plate	
平板Plate	
带固定器With Fixing Flanges	
带销钉With Snap-in Mounting Feet	
按键Press Button	
固定支架Fixed Support	
跨接件Jumper	
位数Poles No.	
2	

技术参数Technical Parameter		
厚度Thickness	宽度Width	高度Height
6	28.1	18
额定参数Rated Parameters		
IEC	UL	
500	300	
24	15	
接线容量Wire Range		
刚性Solid	柔性Fine Stranded	带冷压头Furrule
0.2-2.5	0.2-2.5	0.2-1.5
28-14	28-14	28-14
其余参数Other Parameters		
绝缘材料/阻燃等级, 符合UL94 Insulating Material / Flame Retardant Grade, Conforming To UL94		
剥线长度Strip length		
8-9		

技术参数Technical Parameter		
厚度Thickness	宽度Width	高度Height
10	28.1	18
额定参数Rated Parameters		
IEC	UL	
500	300	
24	15	
接线容量Wire Range		
刚性Solid	柔性Fine Stranded	带冷压头Furrule
0.2-2.5	0.2-2.5	0.2-1.5
28-14	28-14	28-14
其余参数Other Parameters		
绝缘材料/阻燃等级, 符合UL94 Insulating Material / Flame Retardant Grade, Conforming To UL94		
剥线长度Strip length		
8-9		

技术参数Technical Parameter		
厚度Thickness	宽度Width	高度Height
6	28.1	18
额定参数Rated Parameters		
IEC	UL	
500	300	
24	15	
接线容量Wire Range		
刚性Solid	柔性Fine Stranded	带冷压头Furrule
0.2-2.5	0.2-2.5	0.2-1.5
28-14	28-14	28-14
其余参数Other Parameters		
绝缘材料/阻燃等级, 符合UL94 Insulating Material / Flame Retardant Grade, Conforming To UL94		
剥线长度Strip length		
8-9		

技术参数Technical Parameter		
厚度Thickness	宽度Width	高度Height
10	28.1	18
额定参数Rated Parameters		
IEC	UL	
500	300	
24	15	
接线容量Wire Range		
刚性Solid	柔性Fine Stranded	带冷压头Furrule
0.2-2.5	0.2-2.5	0.2-1.5
28-14	28-14	28-14
其余参数Other Parameters		
绝缘材料/阻燃等级, 符合UL94 Insulating Material / Flame Retardant Grade, Conforming To UL94		
剥线长度Strip length		
8-9		

订货信息Order Information	
订货号Order NO.	
241311	
241312	
241313	
241314	
241315	
241316	
241317	
241319	

订货信息Order Information	
订货号Order NO.	
241341	
241342	
241343	
241344	
241345	
241346	
241347	
241349	

订货信息Order Information	
订货号Order NO.	
241321	
241322	
241323	
241324	
241325	
241326	
241327	
241329	

订货信息Order Information	
订货号Order NO.	
241351	
241352	
241353	
241354	
241355	
241356	
241357	
241358	

配套附件Accessory	
订货号Order NO.	
241641	
241642	
*	
*	
241631	
241632	
241221	
241019	
跨接件Jumper	
位数Poles No.	颜色Colour
2	灰Gray

配套附件Accessory	
订货号Order NO.	
241641	
241642	
*	
*	
241631	
241632	
241221	
241019	
跨接件Jumper	
位数Poles No.	颜色Colour
2	灰Gray

配套附件Accessory	
订货号Order NO.	
241641	
241642	
*	
*	
241631	
241632	
241221	
241019	
跨接件Jumper	
位数Poles No.	颜色Colour
2	灰Gray

配套附件Accessory	
订货号Order NO.	
241641	
241642	
*	
*	
241631	
241632	
241221	
241019	
跨接件Jumper	
位数Poles No.	颜色Colour
2	灰Gray

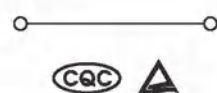
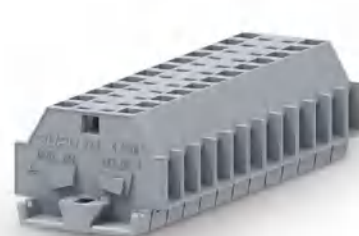

242系列一进一出带固定器侧面接线端子
242 Series 1-1 Feed Through Terminal Block With Fixing Flanges of Side-entry

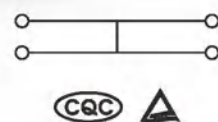

242系列两进两出带固定器侧面接线端子
242 Series 2-2 Feed Through Terminal Block With Fixing Flanges of Side-entry

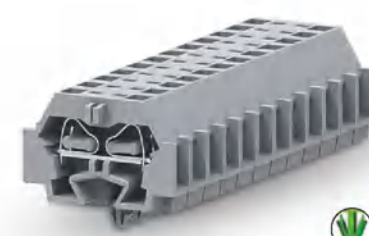

242系列一进一出带销钉侧面接线端子
242 Series 1-1 Feed Through Terminal Block With Snap-in Mounting Feet of Side-entry

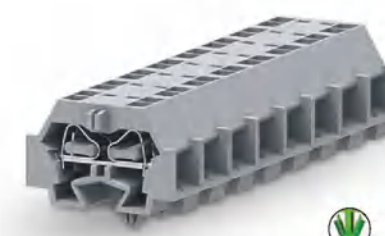

242系列两进两出带销钉侧面接线端子
242 Series 2-2 Feed Through Terminal Block With Snap-in Mounting Feet of Side-entry

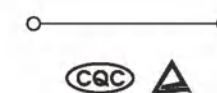
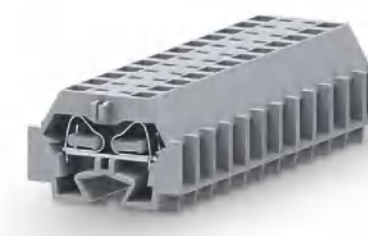

242系列一进一出侧面接线终端用端子
242 Series 1-1 Feed Through End Terminal Block With Snap-in Mounting Feet of Side-entry

		技术参数Technical Parameter			技术参数Technical Parameter			技术参数Technical Parameter			技术参数Technical Parameter		
尺寸Size		厚度Thickness	宽度Width	高度Height	厚度Thickness	宽度Width	高度Height	厚度Thickness	宽度Width	高度Height	厚度Thickness	宽度Width	高度Height
[mm]		7	33.6	23.1	12	33.6	23.1	7	33.6	23.1	7	33.6	23.1
额定参数Rated Parameters		IEC	UL		IEC	UL		IEC	UL		IEC	UL	
额定电压Rated Voltage [V]		630	300		630	300		630	300		630	300	
额定电流Rated Current [A]		24	20		32	20		24	20		24	20	
接线容量Wire Range		刚性Solid	柔性Fine Stranded	带冷压头Furrule	刚性Solid	柔性Fine Stranded	带冷压头Furrule	刚性Solid	柔性Fine Stranded	带冷压头Furrule	刚性Solid	柔性Fine Stranded	带冷压头Furrule
[mm ²]		0.2-4	0.2-4	0.2-2.5	0.2-4	0.2-4	0.2-2.5	0.2-4	0.2-4	0.2-2.5	0.2-4	0.2-4	0.2-2.5
[AWG]		28-12	28-12	28-12	28-12	28-12	28-12	28-12	28-12	28-12	28-12	28-12	28-12
其余参数Other Parameters													
绝缘材料/阻燃等级, 符合UL94 Insulating Material / Flame Retardant Grade, Conforming To UL94		V0			V0			V0			V0		
剥线长度Strip length [mm]		9-10			9-10			9-10			9-10		
产品Product		颜色Colour			订货信息Order Information			订货信息Order Information			订货信息Order Information		
灰Gray		订货号Order NO.			订货号Order NO.			订货号Order NO.			订货号Order NO.		
橙Orange		242301			242331			242311			242341		
白灰Light gray		242302			242332			242312			242342		
适配NS 35/7.5导轨 Can Be Used For DIN Rail NS 35/7.5		242303			242333			242313			242343		
蓝Blue		242304			242334			242314			242344		
黄Yellow		242305			242335			242315			242345		
绿Green		242306			242336			242316			242346		
黄绿Yellow green		242307			242337			242317			242347		
粉Pink		242309			242339			242319			242349		
端板Cover Plate		配套附件Accessory			配套附件Accessory			配套附件Accessory			配套附件Accessory		
平板Plate		订货号Order NO.			订货号Order NO.			订货号Order NO.			订货号Order NO.		
灰Gray		*			*			242641			242641		
橙Orange		*			*			242642			242642		
带固定器With Fixing Flanges		242621			242621			*			*		
灰Gray		242622			242622			*			*		
带销钉With Snap-in Mounting Feet		*			*			242631			242631		
灰Gray		*			*			242632			242632		
橙Orange		*			*			*			*		
按键Press Button		*			*			*			*		
白White		241019			241019			241019			241019		
固定支架Fixed Support		灰Gray			241019			241019			241019		
跨接件Jumper		跨接件Jumper			跨接件Jumper			跨接件Jumper			跨接件Jumper		
位数Poles No.		颜色Colour			订货号Order NO.			订货号Order NO.			订货号Order NO.		
2		灰Gray			242601			242601			242601		

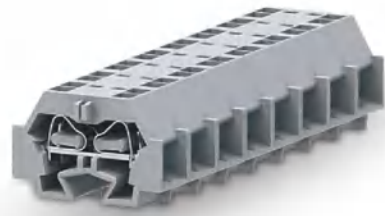

242系列两进两出侧面接线终端用端子
242 Series 2-2 Feed Through End Terminal Block
With Snap-in Mounting Feet of Side-entry

尺寸Size		技术参数Technical Parameter		
厚度Thickness	[mm]	12	33.6	23.1
额定参数Rated Parameters		IEC	UL	
额定电压Rated Voltage	[V]	630	300	
额定电流Rated Current	[A]	32	20	
接线容量Wire Range		刚性Solid	柔性Fine Stranded	带冷压头Furrule
	[mm ²]	0.2-4	0.2-4	0.2-2.5
	[AWG]	28-12	28-12	28-12
其余参数Other Parameters		绝缘材料/阻燃等级, 符合UL94 Insulating Material / Flame Retardant Grade, Conforming To UL94		
剥线长度Strip length	[mm]	9-10		
产品Product		订货信息Order Information		
适配NS 35/7.5导轨 Can Be Used For DIN Rail NS 35/7.5	颜色Colour	订货号Order NO.		
	灰Gray	242351		
	橙Orange	242352		
	白灰Light gray	242353		
	蓝Blue	242354		
	黄Yellow	242355		
	绿Green	242356		
	黄绿Yellow green	242357		
粉Pink	242359			
端板Cover Plate		配套附件Accessory		
平板Plate	灰Gray	订货号Order NO.		
	橙Orange	242641		
带固定器With Fixing Flanges	灰Gray	242642		
	橙Orange	*		
带销钉With Snap-in Mounting Feet	灰Gray	242631		
	橙Orange	242632		
按键Press Button	白White	*		
固定支架Fixed Support	灰Gray	241019		
跨接件Jumper		配套附件Accessory		
位数Poles No.	颜色Colour	订货号Order NO.		
2	灰Gray	242601		



254系列一进一出带固定器正面接线端子
254 Series 1-1 Feed Through Terminal Block
With Fixing Flanges of Front-entry

尺寸Size		技术参数Technical Parameter		
厚度Thickness	[mm]	6	32	22.2
额定参数Rated Parameters		IEC	UL	
额定电压Rated Voltage	[V]	800	600	
额定电流Rated Current	[A]	24	20	
接线容量Wire Range		刚性Solid	柔性Fine Stranded	带冷压头Furrule
	[mm ²]	0.2-2.5	0.2-2.5	0.2-1.5
	[AWG]	28-12	28-12	28-12
其余参数Other Parameters		绝缘材料/阻燃等级, 符合UL94 Insulating Material / Flame Retardant Grade, Conforming To UL94		
剥线长度Strip length	[mm]	8-9		
产品Product		订货信息Order Information		
适配NS 35/7.5导轨 Can Be Used For DIN Rail NS 35/7.5	颜色Colour	订货号Order NO.		
	灰Gray	254301		
	橙Orange	254302		
	白灰Light gray	254303		
	蓝Blue	254304		
	黄Yellow	254305		
	绿Green	254306		
	黄绿Yellow green	254307		
粉Pink	*			
端板Cover Plate		配套附件Accessory		
平板Plate	灰Gray	订货号Order NO.		
	橙Orange	254625		
带固定器With Fixing Flanges	灰Gray	254626		
	橙Orange	254621		
带销钉With Snap-in Mounting Feet	灰Gray	254622		
	橙Orange	*		
按键Press Button	白White	*		
固定支架Fixed Support	灰Gray	*		
跨接件Jumper		配套附件Accessory		
位数Poles No.	颜色Colour	订货号Order NO.		
2	灰Gray	*		

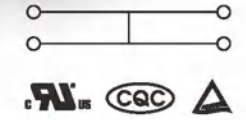

254系列两进两出带固定器正面接线端子
254 Series 2-2 Feed Through Terminal Block
With Fixing Flanges of Front-entry

尺寸Size		技术参数Technical Parameter		
厚度Thickness	[mm]	10	32	22.2
额定参数Rated Parameters		IEC	UL	
额定电压Rated Voltage	[V]	800	600	
额定电流Rated Current	[A]	24	20	
接线容量Wire Range		刚性Solid	柔性Fine Stranded	带冷压头Furrule
	[mm ²]	0.2-2.5	0.2-2.5	0.2-1.5
	[AWG]	28-12	28-12	28-12
其余参数Other Parameters		绝缘材料/阻燃等级, 符合UL94 Insulating Material / Flame Retardant Grade, Conforming To UL94		
剥线长度Strip length	[mm]	8-9		
产品Product		订货信息Order Information		
适配NS 35/7.5导轨 Can Be Used For DIN Rail NS 35/7.5	颜色Colour	订货号Order NO.		
	灰Gray	254331		
	橙Orange	254332		
	白灰Light gray	254333		
	蓝Blue	254334		
	黄Yellow	254335		
	绿Green	254336		
	黄绿Yellow green	254337		
粉Pink	*			
端板Cover Plate		配套附件Accessory		
平板Plate	灰Gray	订货号Order NO.		
	橙Orange	254625		
带固定器With Fixing Flanges	灰Gray	254626		
	橙Orange	254621		
带销钉With Snap-in Mounting Feet	灰Gray	254622		
	橙Orange	*		
按键Press Button	白White	*		
固定支架Fixed Support	灰Gray	*		
跨接件Jumper		配套附件Accessory		
位数Poles No.	颜色Colour	订货号Order NO.		
2	灰Gray	*		

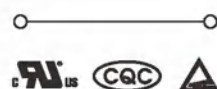

254系列一进一出带销钉正面接线端子
254 Series 1-1 Feed Through Terminal Block With Snap-in Mounting Feet of Front-entry

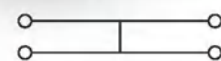

254系列两进两出带销钉正面接线端子
254 Series 2-2 Feed Through Terminal Block With Snap-in Mounting Feet of Front-entry



254系列一进一出正面接线中间端子
254 Series 1-1 Feed Through Middle Terminal Block of Front-entry

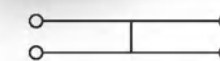

254系列两进两出正面接线中间端子
254 Series 2-2 Feed Through Middle Terminal Block of Front-entry

尺寸Size	
[mm]	6
额定参数Rated Parameters	
额定电压Rated Voltage [V]	800
额定电流Rated Current [A]	24
接线容量Wire Range	
[mm ²]	0.2-2.5
[AWG]	28-12
其余参数Other Parameters	
绝缘材料/阻燃等级, 符合UL94 Insulating Material / Flame Retardant Grade, Conforming To UL94	V0
剥线长度Strip length [mm]	8-9
产品Product	
颜色Colour	灰Gray
	橙Orange
	白灰Light gray
	蓝Blue
	黄Yellow
	绿Green
	黄绿Yellow green
	粉Pink
适配NS 35/7.5导轨 Can Be Used For DIN Rail NS 35/7.5	
端板Cover Plate	
平板Plate	灰Gray
	橙Orange
带固定器With Fixing Flanges	灰Gray
	橙Orange
带销钉 With Snap-in Mounting Feet	灰Gray
	橙Orange
按键Press Button	白White
固定支架Fixed Support	灰Gray
跨接件Jumper	
位数Poles No.	颜色Colour
2	灰Gray

技术参数Technical Parameter		
厚度Thickness	宽度Width	高度Height
6	32	22.2
IEC	UL	
800	600	
24	20	
接线容量Wire Range		
刚性Solid	柔性Fine Stranded	带冷压头Furrule
0.2-2.5	0.2-2.5	0.2-1.5
28-12	28-12	28-12
其余参数Other Parameters		
绝缘材料/阻燃等级, 符合UL94 Insulating Material / Flame Retardant Grade, Conforming To UL94		
V0		
剥线长度Strip length [mm]		
8-9		

技术参数Technical Parameter		
厚度Thickness	宽度Width	高度Height
10	32	22.2
IEC	UL	
800	600	
24	20	
接线容量Wire Range		
刚性Solid	柔性Fine Stranded	带冷压头Furrule
0.2-2.5	0.2-2.5	0.2-1.5
28-12	28-12	28-12
其余参数Other Parameters		
绝缘材料/阻燃等级, 符合UL94 Insulating Material / Flame Retardant Grade, Conforming To UL94		
V0		
剥线长度Strip length [mm]		
8-9		

技术参数Technical Parameter		
厚度Thickness	宽度Width	高度Height
6	32	22.2
IEC	UL	
800	600	
24	20	
接线容量Wire Range		
刚性Solid	柔性Fine Stranded	带冷压头Furrule
0.2-2.5	0.2-2.5	0.2-1.5
28-12	28-12	28-12
其余参数Other Parameters		
绝缘材料/阻燃等级, 符合UL94 Insulating Material / Flame Retardant Grade, Conforming To UL94		
V0		
剥线长度Strip length [mm]		
8-9		

技术参数Technical Parameter		
厚度Thickness	宽度Width	高度Height
10	32	22.2
IEC	UL	
800	600	
24	20	
接线容量Wire Range		
刚性Solid	柔性Fine Stranded	带冷压头Furrule
0.2-2.5	0.2-2.5	0.2-1.5
28-12	28-12	28-12
其余参数Other Parameters		
绝缘材料/阻燃等级, 符合UL94 Insulating Material / Flame Retardant Grade, Conforming To UL94		
V0		
剥线长度Strip length [mm]		
8-9		

订货信息Order Information	
产品Product	颜色Colour
	灰Gray
	橙Orange
	白灰Light gray
	蓝Blue
	黄Yellow
	绿Green
	黄绿Yellow green
	粉Pink

订货信息Order Information	
产品Product	颜色Colour
	灰Gray
	橙Orange
	白灰Light gray
	蓝Blue
	黄Yellow
	绿Green
	黄绿Yellow green
	粉Pink

订货信息Order Information	
产品Product	颜色Colour
	灰Gray
	橙Orange
	白灰Light gray
	蓝Blue
	黄Yellow
	绿Green
	黄绿Yellow green
	粉Pink

订货信息Order Information	
产品Product	颜色Colour
	灰Gray
	橙Orange
	白灰Light gray
	蓝Blue
	黄Yellow
	绿Green
	黄绿Yellow green
	粉Pink

订货信息Order Information	
产品Product	颜色Colour
	灰Gray
	橙Orange
	白灰Light gray
	蓝Blue
	黄Yellow
	绿Green
	黄绿Yellow green
	粉Pink

配套附件Accessory	
端板Cover Plate	颜色Colour
平板Plate	灰Gray
	橙Orange
带固定器With Fixing Flanges	灰Gray
	橙Orange
带销钉 With Snap-in Mounting Feet	灰Gray
	橙Orange
按键Press Button	白White
固定支架Fixed Support	灰Gray
跨接件Jumper	
位数Poles No.	颜色Colour
2	灰Gray

配套附件Accessory	
端板Cover Plate	颜色Colour
平板Plate	灰Gray
	橙Orange
带固定器With Fixing Flanges	灰Gray
	橙Orange
带销钉 With Snap-in Mounting Feet	灰Gray
	橙Orange
按键Press Button	白White
固定支架Fixed Support	灰Gray
跨接件Jumper	
位数Poles No.	颜色Colour
2	灰Gray

配套附件Accessory	
端板Cover Plate	颜色Colour
平板Plate	灰Gray
	橙Orange
带固定器With Fixing Flanges	灰Gray
	橙Orange
带销钉 With Snap-in Mounting Feet	灰Gray
	橙Orange
按键Press Button	白White
固定支架Fixed Support	灰Gray
跨接件Jumper	
位数Poles No.	颜色Colour
2	灰Gray

配套附件Accessory	
端板Cover Plate	颜色Colour
平板Plate	灰Gray
	橙Orange
带固定器With Fixing Flanges	灰Gray
	橙Orange
带销钉 With Snap-in Mounting Feet	灰Gray
	橙Orange
按键Press Button	白White
固定支架Fixed Support	灰Gray
跨接件Jumper	
位数Poles No.	颜色Colour
2	灰Gray

配套附件Accessory	
端板Cover Plate	颜色Colour
平板Plate	灰Gray
	橙Orange
带固定器With Fixing Flanges	灰Gray
	橙Orange
带销钉 With Snap-in Mounting Feet	灰Gray
	橙Orange
按键Press Button	白White
固定支架Fixed Support	灰Gray
跨接件Jumper	
位数Poles No.	颜色Colour
2	灰Gray

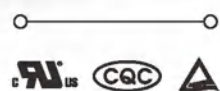

254系列一进一出正面接线端子(小导轨15)
254 Series 1-1 Feed Through Terminal Block of Front-entry (SP15x7.5)



254系列两进两出正面接线端子(小导轨15)
254 Series 2-2 Feed Through Terminal Block of Front-entry (SP15x7.5)



254系列一进一出正面接线端子(大导轨35)
254 Series 1-1 Feed Through Terminal Block of Front-entry (SP35x7.5)



254系列两进两出正面接线端子(大导轨35)
254 Series 2-2 Feed Through Terminal Block of Front-entry (SP35x7.5)

尺寸Size	
[mm]	
额定参数Rated Parameters	
额定电压Rated Voltage	[V]
额定电流Rated Current	[A]
接线容量Wire Range	
[mm ²]	
[AWG]	
其余参数Other Parameters	
绝缘材料/阻燃等级, 符合UL94 Insulating Material / Flame Retardant Grade, Conforming To UL94	
剥线长度Strip length	[mm]
产品Product	
颜色Colour	
灰Gray	
橙Orange	
白灰Light gray	
蓝Blue	
黄Yellow	
绿Green	
黄绿Yellow green	
粉Pink	
适配NS 35/7.5导轨 Can Be Used For DIN Rail NS 35/7.5	
端板Cover Plate	
平板Plate	
带固定器With Fixing Flanges	
带销钉With Snap-in Mounting Feet	
按键Press Button	
固定支架Fixed Support	
跨接件Jumper	
位数Poles No.	
颜色Colour	
2	灰Gray

技术参数Technical Parameter		
厚度Thickness	宽度Width	高度Height
6	32	32.1
IEC	UL	
800	600	
24	20	
接线容量Wire Range		
刚性Solid	柔性Fine Stranded	带冷压头Furrule
0.2-2.5	0.2-2.5	0.2-1.5
28-12	28-12	28-12
其余参数Other Parameters		
绝缘材料/阻燃等级, 符合UL94 Insulating Material / Flame Retardant Grade, Conforming To UL94		
剥线长度Strip length		
8-9		

订货信息Order Information	
订货号Order NO.	
灰Gray	254361
橙Orange	254362
白灰Light gray	254363
蓝Blue	254364
黄Yellow	254365
绿Green	254366
黄绿Yellow green	254367
粉Pink	*

配套附件Accessory	
订货号Order NO.	
平板Plate	灰Gray 254625
平板Plate	橙Orange 254626
带固定器With Fixing Flanges	灰Gray 254621
带固定器With Fixing Flanges	橙Orange 254622
带销钉With Snap-in Mounting Feet	灰Gray *
带销钉With Snap-in Mounting Feet	橙Orange *
按键Press Button	白White *
固定支架Fixed Support	灰Gray *
跨接件Jumper	
位数Poles No.	订货号Order NO.
2	灰Gray *

技术参数Technical Parameter		
厚度Thickness	宽度Width	高度Height
10	32	32.1
IEC	UL	
800	600	
24	20	
接线容量Wire Range		
刚性Solid	柔性Fine Stranded	带冷压头Furrule
0.2-2.5	0.2-2.5	0.2-1.5
28-12	28-12	28-12
其余参数Other Parameters		
绝缘材料/阻燃等级, 符合UL94 Insulating Material / Flame Retardant Grade, Conforming To UL94		
剥线长度Strip length		
8-9		

订货信息Order Information	
订货号Order NO.	
灰Gray	254391
橙Orange	254392
白灰Light gray	254393
蓝Blue	254394
黄Yellow	254395
绿Green	254396
黄绿Yellow green	254397
粉Pink	*

配套附件Accessory	
订货号Order NO.	
平板Plate	灰Gray 254625
平板Plate	橙Orange 254626
带固定器With Fixing Flanges	灰Gray 254621
带固定器With Fixing Flanges	橙Orange 254622
带销钉With Snap-in Mounting Feet	灰Gray *
带销钉With Snap-in Mounting Feet	橙Orange *
按键Press Button	白White *
固定支架Fixed Support	灰Gray *
跨接件Jumper	
位数Poles No.	订货号Order NO.
2	灰Gray *

技术参数Technical Parameter		
厚度Thickness	宽度Width	高度Height
6	32	32.1
IEC	UL	
800	600	
24	20	
接线容量Wire Range		
刚性Solid	柔性Fine Stranded	带冷压头Furrule
0.2-2.5	0.2-2.5	0.2-1.5
28-12	28-12	28-12
其余参数Other Parameters		
绝缘材料/阻燃等级, 符合UL94 Insulating Material / Flame Retardant Grade, Conforming To UL94		
剥线长度Strip length		
8-9		

订货信息Order Information	
订货号Order NO.	
灰Gray	254371
橙Orange	254372
白灰Light gray	254373
蓝Blue	254374
黄Yellow	254375
绿Green	254376
黄绿Yellow green	254377
粉Pink	*

配套附件Accessory	
订货号Order NO.	
平板Plate	灰Gray 254625
平板Plate	橙Orange 254626
带固定器With Fixing Flanges	灰Gray 254621
带固定器With Fixing Flanges	橙Orange 254622
带销钉With Snap-in Mounting Feet	灰Gray *
带销钉With Snap-in Mounting Feet	橙Orange *
按键Press Button	白White *
固定支架Fixed Support	灰Gray *
跨接件Jumper	
位数Poles No.	订货号Order NO.
2	灰Gray *

技术参数Technical Parameter		
厚度Thickness	宽度Width	高度Height
10	37	31.6
IEC	UL	
800	600	
24	20	
接线容量Wire Range		
刚性Solid	柔性Fine Stranded	带冷压头Furrule
0.2-2.5	0.2-2.5	0.2-1.5
28-12	28-12	28-12
其余参数Other Parameters		
绝缘材料/阻燃等级, 符合UL94 Insulating Material / Flame Retardant Grade, Conforming To UL94		
剥线长度Strip length		
8-9		

订货信息Order Information	
订货号Order NO.	
灰Gray	254381
橙Orange	254382
白灰Light gray	254383
蓝Blue	254384
黄Yellow	254385
绿Green	254386
黄绿Yellow green	254387
粉Pink	*

配套附件Accessory	
订货号Order NO.	
平板Plate	灰Gray 254625
平板Plate	橙Orange 254626
带固定器With Fixing Flanges	灰Gray 254621
带固定器With Fixing Flanges	橙Orange 254622
带销钉With Snap-in Mounting Feet	灰Gray *
带销钉With Snap-in Mounting Feet	橙Orange *
按键Press Button	白White *
固定支架Fixed Support	灰Gray *
跨接件Jumper	
位数Poles No.	订货号Order NO.
2	灰Gray *

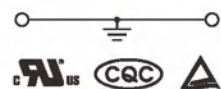
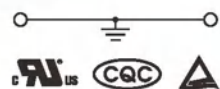

254系列一进一出正面接地端子(小导轨15)
254 Series 1-1 Feed Through Ground Terminal Block of Front-entry (SP15x7.5)

254系列一进一出正面接地端子(大导轨35)
254 Series 1-1 Feed Through Ground Terminal Block of Front-entry (SP35x7.5)

		技术参数Technical Parameter			技术参数Technical Parameter		
尺寸Size		厚度Thickness	宽度Width	高度Height	厚度Thickness	宽度Width	高度Height
	[mm]	6	32	32.9	6	42.6	33.5
额定参数Rated Parameters		IEC	UL		IEC	UL	
额定电压Rated Voltage	[V]	*	*		*	*	
额定电流Rated Current	[A]	*	*		*	*	
接线容量Wire Range		刚性Solid	柔性Fine Stranded	带冷压头Furrule	刚性Solid	柔性Fine Stranded	带冷压头Furrule
	[mm ²]	0.2-2.5	0.2-2.5	0.2-1.5	0.2-2.5	0.2-2.5	0.2-1.5
	[AWG]	28-12	28-12	28-12	28-12	28-12	28-12
其余参数Other Parameters							
绝缘材料/阻燃等级, 符合UL94 Insulating Material / Flame Retardant Grade, Conforming To UL94		V0			V0		
剥线长度Strip length	[mm]	8-9			8-9		
产品Product	颜色Colour	订货信息Order Information			订货信息Order Information		
	黄绿Yellow green	订货号Order NO.			订货号Order NO.		
		254507			254607		
适配NS 35/7.5导轨 Can Be Used For DIN Rail NS 35/7.5							
端板Cover Plate		配套附件Accessory			配套附件Accessory		
		订货号Order NO.			订货号Order NO.		
平板Plate	灰Gray	254625			254625		
	橙Orange	254626			254626		
带固定器With Fixing Flanges	灰Gray	254621			254621		
	橙Orange	254622			254622		
带销钉With Snap-in Mounting Feet	灰Gray	*			*		
	橙Orange	*			*		
按键Press Button	白White	*			*		
固定支架Fixed Support	灰Gray	*			*		
跨接件Jumper							
位数Poles No.	颜色Colour	订货号Order NO.			订货号Order NO.		
2	灰Gray	*			*		

附件 Accessory

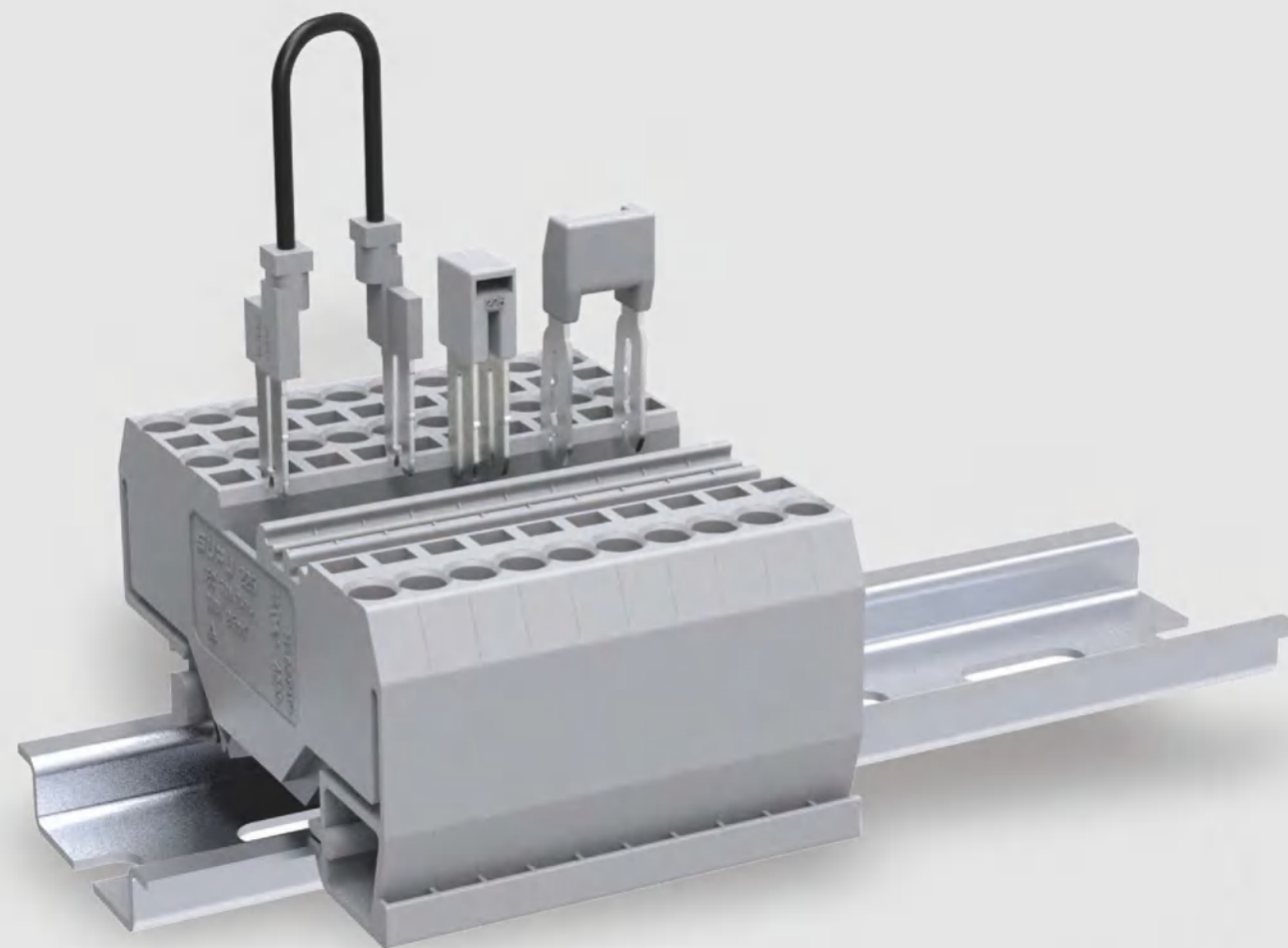

终端固定器 End stop



	SPD35螺钉 SPD35 Screw	SPD35卡式 T=10mm SPD 35 Clip T=10.0mm	双层弹簧端子终端固定器 Double level terminal block end stop
	技术参数 Technical Parameter		
尺寸Size 注: 安装NS35/7.5导轨后的高度 Note: Height With DIN Rail NS 35/7.5	厚度Thickness 9.5 宽度Width 46.1 高度Height 35.1	厚度Thickness 10 宽度Width 43.7 高度Height 28	厚度Thickness 10 宽度Width 55.5 高度Height 50
其余参数 Other Parameters 绝缘材料/阻燃等级, 符合UL94 Insulating Material / Flame Retardant Grade, Conforming To UL94	V0		
	订货信息 Order Information		
适配NS 35/7.5导轨 Can Be Used For DIN Rail NS 35/7.5	颜色Colour 灰Gray		
包装数量 Package quantity	订货号 Order NO. 215201 100	订货号 Order NO. 215202 100	订货号 Order NO. 215207 100
适用轨道/型号 Can Be Used For DIN Rail	订货号 Order NO. 900421/011 900421/031 900401/001 900421/021 900431/001	订货号 Order NO. 900421/011 900421/031 900401/001 900421/021 900431/001 215210	订货号 Order NO. 900421/011 900421/031 900401/001 900421/021 900431/001
标记 Marker 可提供印字服务 Printing Service	订货号 Order NO. *	订货号 Order NO. 225801	订货号 Order NO. TMB10.2-10

	SPD15卡式 T=5.2mm SPD 15 Clip T=5.2mm
	技术参数 Technical Parameter
尺寸Size 注: 安装NS35/7.5导轨后的高度 Note: Height With DIN Rail NS 35/7.5	厚度Thickness 5.2 宽度Width 22.7 高度Height 22.1
其余参数 Other Parameters 绝缘材料/阻燃等级, 符合UL94 Insulating Material / Flame Retardant Grade, Conforming To UL94	V0
	订货信息 Order Information
适配NS 35/7.5导轨 Can Be Used For DIN Rail NS 35/7.5	颜色Colour 灰Gray
包装数量 Package quantity	订货号 Order NO. 215208 100
适用轨道/型号 Can Be Used For DIN Rail	订货号 Order NO. 900421/061
标记 Marker 可提供印字服务 Printing Service	订货号 Order NO. 305801

终端标识牌 End stop marking



	SPD35卡式 T=6mm SPD 35 Clip T=6mm	SPD35螺钉 SPD35 Screw	SP15 导轨固定器 SP15 Screw
	技术参数 Technical Parameter		
尺寸Size 注: 安装NS35/7.5导轨后的高度 Note: Height With DIN Rail NS 35/7.5	厚度Thickness 6 宽度Width 43.7 高度Height 28	厚度Thickness 9.4 宽度Width 44.1 高度Height 33	厚度Thickness 6 宽度Width 22 高度Height 11.6
其余参数 Other Parameters 绝缘材料/阻燃等级, 符合UL94 Insulating Material / Flame Retardant Grade, Conforming To UL94	V0		
	订货信息 Order Information		
适配NS 35/7.5导轨 Can Be Used For DIN Rail NS 35/7.5	颜色Colour 灰Gray		
包装数量 Package quantity	订货号 Order NO. 215203 100	订货号 Order NO. 215204 100	订货号 Order NO. 215206 100
适用轨道/型号 Can Be Used For DIN Rail	订货号 Order NO. 900421/011 900421/031 900401/001 900421/021 900431/001	订货号 Order NO. 900421/011 900421/031 900401/001 900421/021 900431/001 215214	订货号 Order NO. 900421/061
标记 Marker 可提供印字服务 Printing Service	订货号 Order NO. 225801	订货号 Order NO. *	订货号 Order NO. *

	铭牌支持件 Nameplate holder	透明标识牌 Transparent Marker card
	技术参数 Technical Parameter	
尺寸Size 注: 安装NS35/7.5导轨后的高度 Note: Height With DIN Rail NS 35/7.5	厚度Thickness 1.0 宽度Width 30.5 高度Height 10	厚度Thickness 9.4 宽度Width 46 高度Height 36.8
其余参数 Other Parameters 绝缘材料/阻燃等级, 符合UL94 Insulating Material / Flame Retardant Grade, Conforming To UL94	V0	
	订货信息 Order Information	
适配NS 35/7.5导轨 Can Be Used For DIN Rail NS 35/7.5	颜色Colour 灰Gray	
包装数量 Package quantity	订货号 Order NO. 215210 100	订货号 Order NO. 215214 100
适用轨道/型号 Can Be Used For DIN Rail	订货号 Order NO. 215202 215203	订货号 Order NO. 215204
标记 Marker 可提供印字服务 Printing Service	订货号 Order NO. *	订货号 Order NO. *

导轨转换器 Rail transfer



导轨转换器 [用于254端子带销钉]
254 Rail transfer

450导轨转换器
450 Rail transfer

450导轨转换器(适用于继电器模块)
450 Rail transfer

	技术参数Technical Parameter			技术参数Technical Parameter			技术参数Technical Parameter		
尺寸Size 注: 安装NS35/7.5导轨后的高度 Note: Height With DIN Rail NS 35/7.5	厚度Thickness	宽度Width	高度Height	厚度Thickness	宽度Width	高度Height	厚度Thickness	宽度Width	高度Height
	6	38	12.7	6.4	41.7	10.6	4.9	42.8	14.3
其余参数Other Parameters 绝缘材料/阻燃等级, 符合UL94 Insulating Material / Flame Retardant Grade, Conforming To UL94	V0			V0			V0		
订货信息Order Information	订货号Order NO. 254611			订货号Order NO. 450018			订货号Order NO. 450017		
包装数量Package quantity	100			100			100		
适用轨道/型号 Can Be Used For DIN Rail	适用于SP254微型端子 (带销钉) Apply to SP 254 miniature terminal block (with snap in mounting feet)			适用于SP450/475连接器; SP240/241/242微型端子 (带销钉) Apply to SP 450/475 connector SP240/241/242 miniature terminal block (with snap in mounting feet)			适用于继电器模块 Apply to relay module		
标记Marker 可提供印字服务Printing Service	订货号Order NO. *			订货号Order NO. *			订货号Order NO. *		



241 导轨转换器
241 Rail transfer

	技术参数Technical Parameter		
尺寸Size 注: 安装NS35/7.5导轨后的高度 Note: Height With DIN Rail NS 35/7.5	厚度Thickness	宽度Width	高度Height
	6.3	43.3	10.5
其余参数Other Parameters 绝缘材料/阻燃等级, 符合UL94 Insulating Material / Flame Retardant Grade, Conforming To UL94	V0		
订货信息Order Information	订货号Order NO. 241019		
包装数量Package quantity	100		
适用轨道/型号 Can Be Used For DIN Rail	适用于SP241微型端子 (带固定器) Apply to SP241 miniature terminal block(with end stop)		
标记Marker 可提供印字服务Printing Service	订货号Order NO. *		

分组隔板 Septum



TU隔板
TU Septum

TP隔板
TP Septum

TS-k 隔板
TS-K Septum

	技术参数Technical Parameter			技术参数Technical Parameter			技术参数Technical Parameter		
尺寸Size 注: 安装NS35/7.5导轨后的高度 Note: Height With DIN Rail NS 35/7.5	厚度Thickness	宽度Width	高度Height	厚度Thickness	宽度Width	高度Height	厚度Thickness	宽度Width	高度Height
							1	22.1	22.15
其余参数Other Parameters 绝缘材料/阻燃等级, 符合UL94 Insulating Material / Flame Retardant Grade, Conforming To UL94	V0			V0			V0		
订货信息Order Information	订货号Order NO. ATP-TU			订货号Order NO. ATP-TP			订货号Order NO. 302151		
包装数量Package quantity	100			100			100		
适用轨道/型号 Can Be Used For DIN Rail	TUXX-2系列			TPXX-2系列			UK系列		
标记Marker 可提供印字服务Printing Service	订货号Order NO. *			订货号Order NO. *			订货号Order NO. *		

保护盖板 Butt Plate



塑料/透明保护罩
Transparent rail cover

透明保护罩支架
Support plate

透明保护罩支架(带塑料滚花螺母)
Support plate (With screw)

	技术参数Technical Parameter			技术参数Technical Parameter			技术参数Technical Parameter		
尺寸Size 注: 安装NS35/7.5导轨后的高度 Note: Height With DIN Rail NS 35/7.5	厚度Thickness	宽度Width	高度Height	厚度Thickness	宽度Width	高度Height	厚度Thickness	宽度Width	高度Height
	2	94	44.8	2.2	91.65	72.7	2.2	91.65	89
其余参数Other Parameters 绝缘材料/阻燃等级, 符合UL94 Insulating Material / Flame Retardant Grade, Conforming To UL94	V0			V0			V0		
订货信息Order Information	订货号Order NO. 900601			订货号Order NO. 900611			订货号Order NO. 900612		
包装数量Package quantity	100			100			100		
适用轨道/型号 Can Be Used For DIN Rail	900611 900612			900421/011 900421/031 900401/001 900421/021 900431/001 900601			900421/011 900421/031 900401/001 900421/021 900431/001 900601		
标记Marker 可提供印字服务Printing Service	订货号Order NO. *			订货号Order NO. *			订货号Order NO. *		

TP/TU/TC系列跨接桥 TP/TU/TC Jumper



	TJA3.5	TJA4.2	TJA5.2
	技术参数Technical Parameter		
尺寸Size	厚度Thickness 宽度Width 高度Height	厚度Thickness 宽度Width 高度Height	厚度Thickness 宽度Width 高度Height
其余参数Other Parameters	绝缘材料/阻燃等级, 符合UL94 Insulating Material / Flame Retardant Grade, Conforming To UL94		
	V0	V0	V0
	订货信息Order Information		
位数Poles No.	订货号Order NO.	订货号Order NO.	订货号Order NO.
2	TJA3.5-2	TJA4.2-2	TJA5.2-2
3	TJA3.5-3	TJA4.2-3	TJA5.2-3
.....
9	TJA3.5-9	TJA4.2-9	TJA5.2-9
10	TJA3.5-10	TJA4.2-10	TJA5.2-10
.....			
20			
包装数量Package quantity	50	50	50
适用轨道/型号 Can Be Used For DIN Rail	订货号Order NO. TP1.5; TPD1.5系列	订货号Order NO. TC1.5系列	订货号Order NO. TP2.5;TC2.5;TU2.5系列
标记Marker 可提供印字服务Printing Service	订货号Order NO. *	订货号Order NO. *	订货号Order NO. *



	TJA12.2	TJA16	TJB5.2
	技术参数Technical Parameter		
尺寸Size	厚度Thickness 宽度Width 高度Height	厚度Thickness 宽度Width 高度Height	厚度Thickness 宽度Width 高度Height
其余参数Other Parameters	绝缘材料/阻燃等级, 符合UL94 Insulating Material / Flame Retardant Grade, Conforming To UL94		
	V0	V0	V0
	订货信息Order Information		
位数Poles No.	订货号Order NO.	订货号Order NO.	订货号Order NO.
2	TJA12.2-2	TJA16-2	TJB5.2-2
3			TJB5.2-3
.....		
9			TJB5.2-9
10			TJB5.2-10
.....			
20			
包装数量Package quantity	50	50	50
适用轨道/型号 Can Be Used For DIN Rail	订货号Order NO. TP16;TC16;TU16系列	订货号Order NO. TC35;TU35系列	订货号Order NO. TP2.5;TC2.5;TU2.5系列
标记Marker 可提供印字服务Printing Service	订货号Order NO. *	订货号Order NO. *	订货号Order NO. *

TA系列跨接桥 TA Jumper



	TJA6.2	TJA8.2	TJA10.2
	技术参数Technical Parameter		
尺寸Size	厚度Thickness 宽度Width 高度Height	厚度Thickness 宽度Width 高度Height	厚度Thickness 宽度Width 高度Height
其余参数Other Parameters	绝缘材料/阻燃等级, 符合UL94 Insulating Material / Flame Retardant Grade, Conforming To UL94		
	V0	V0	V0
	订货信息Order Information		
位数Poles No.	订货号Order NO.	订货号Order NO.	订货号Order NO.
2	TJA6.2-2	TJA8.2-2	TJA10.2-2
3	TJA6.2-3	TJA8.2-3	
.....	
9	TJA6.2-9	TJA8.2-9	
10	TJA6.2-10	TJA8.2-10	
.....			
20			
包装数量Package quantity	50	50	50
适用轨道/型号 Can Be Used For DIN Rail	订货号Order NO. TP4;TC4;TU4系列	订货号Order NO. TP6;TC6;TU6系列	订货号Order NO. TP10;TC10;TU10系列
标记Marker 可提供印字服务Printing Service	订货号Order NO. *	订货号Order NO. *	订货号Order NO. *



	215轨装端子相邻跨接桥 215 Adjacent Jumper	225轨装端子相邻跨接桥 225 Adjacent Jumper	204轨装端子相邻跨接桥 204 Adjacent Jumper
	技术参数Technical Parameter		
尺寸Size	厚度Thickness 宽度Width 高度Height	厚度Thickness 宽度Width 高度Height	厚度Thickness 宽度Width 高度Height
	4 22.45 8	4.9 21.9 7.8	6.2 23.7 8
其余参数Other Parameters	绝缘材料/阻燃等级, 符合UL94 Insulating Material / Flame Retardant Grade, Conforming To UL94		
	V0	V0	V0
	订货信息Order Information		
位数Poles No.	订货号Order NO.	订货号Order NO.	订货号Order NO.
2	215301	225301	204301
.....			
包装数量Package quantity	100	100	100
适用轨道/型号 Can Be Used For DIN Rail	订货号Order NO. SP215系列	订货号Order NO. SP225系列	订货号Order NO. SP204系列
标记Marker 可提供印字服务Printing Service	订货号Order NO. *	订货号Order NO. *	订货号Order NO. *

TA系列跨接桥 TA Jumper



206轨装端子相邻跨接桥
206 Adjacent Jumper

210轨装端子相邻跨接桥
210 Adjacent Jumper

216轨装端子相邻跨接桥
216 Adjacent Jumper

尺寸Size	技术参数Technical Parameter			技术参数Technical Parameter			技术参数Technical Parameter			
	厚度Thickness	宽度Width	高度Height	厚度Thickness	宽度Width	高度Height	厚度Thickness	宽度Width	高度Height	
	8	25.5	8	9.7	26.5	9	11	32	13.5	
其余参数Other Parameters	绝缘材料/阻燃等级, 符合UL94 Insulating Material / Flame Retardant Grade, Conforming To UL94			V0			V0			
位数Poles No.	颜色Colour	订货号Order NO.		订货号Order NO.		订货号Order NO.		订货号Order NO.		
2	灰Gray	216301		210301		216301		216301		
包装数量Package quantity	100		100		100		100		100	
适用轨道/型号 Can Be Used For DIN Rail	SP206系列		SP210系列		SP216系列		SP216系列		SP216系列	
标记Marker 可提供印字服务Printing Service	订货号Order NO. *		订货号Order NO. *		订货号Order NO. *		订货号Order NO. *		订货号Order NO. *	



225系列3位灰色交错跨接桥
225 Adjacent Jumper

导线跨接器
Wire Jumper

尺寸Size	技术参数Technical Parameter			技术参数Technical Parameter		
	厚度Thickness	宽度Width	高度Height	厚度Thickness	宽度Width	高度Height
	9.7	25.4	5.75	3.8	24.7	8.1
其余参数Other Parameters	绝缘材料/阻燃等级, 符合UL94 Insulating Material / Flame Retardant Grade, Conforming To UL94			V0		
位数Poles No.	颜色Colour	订货号Order NO.		订货号Order NO.		订货号Order NO.
2	灰Gray	225321-3		225311(L=60mm) 225312(L=110mm) 225313(L=250mm)		225311(L=60mm) 225312(L=110mm) 225313(L=250mm)
包装数量Package quantity	100		100		100	
适用轨道/型号 Can Be Used For DIN Rail	SP225系列		SP225系列		SP225系列	
标记Marker 可提供印字服务Printing Service	订货号Order NO. *		订货号Order NO. *		订货号Order NO. *	

UK系列跨接桥 UK Jumper



302 固定式带绝缘圈螺钉跨接件
302 Fixed screw with insulating ring-jumper

303 固定式带绝缘圈螺钉跨接件
303 Fixed screw with insulating ring-jumper

306 固定式带绝缘圈螺钉跨接件
306 Fixed screw with insulating ring-jumper

尺寸Size	技术参数Technical Parameter			技术参数Technical Parameter			技术参数Technical Parameter			
	厚度Thickness	宽度Width	高度Height	厚度Thickness	宽度Width	高度Height	厚度Thickness	宽度Width	高度Height	
	1	6.15	5.55	1	5.2	5.2	1	8.2	6.4	
其余参数Other Parameters	绝缘材料/阻燃等级, 符合UL94 Insulating Material / Flame Retardant Grade, Conforming To UL94			V0			V0			
位数Poles No.	订货号Order NO.		订货号Order NO.		订货号Order NO.		订货号Order NO.		订货号Order NO.	
2	302302		303302		306302		306302		306302	
3	302303		303303		306303		306303		306303	
.....	
9	302309		303309		306309		306309		306309	
10	302310		303310		306310		306310		306310	
包装数量Package quantity	100		100		100		100		100	
适用轨道/型号 Can Be Used For DIN Rail	SP302系列; 305系列		SP303系列		SP306系列		SP306系列		SP306系列	
标记Marker 可提供印字服务Printing Service	订货号Order NO. *		订货号Order NO. *		订货号Order NO. *		订货号Order NO. *		订货号Order NO. *	



310 固定式带绝缘圈螺钉跨接件
310 Fixed screw with insulating ring-jumper

316 固定式带绝缘圈螺钉跨接件
316 Fixed screw with insulating ring-jumper

335 固定式带绝缘圈螺钉跨接件
335 Fixed screw with insulating ring-jumper

尺寸Size	技术参数Technical Parameter			技术参数Technical Parameter			技术参数Technical Parameter			
	厚度Thickness	宽度Width	高度Height	厚度Thickness	宽度Width	高度Height	厚度Thickness	宽度Width	高度Height	
	1.5	10.2	7.6	1.5	12.6	7.6	1.5	16	7.6	
其余参数Other Parameters	绝缘材料/阻燃等级, 符合UL94 Insulating Material / Flame Retardant Grade, Conforming To UL94			V0			V0			
位数Poles No.	订货号Order NO.		订货号Order NO.		订货号Order NO.		订货号Order NO.		订货号Order NO.	
2	310302		316302		335302		335302		335302	
3	310303		316303		335303		335303		335303	
.....	
9	310309		316309		335309		335309		335309	
10	310310		316310		335310		335310		335310	
包装数量Package quantity	100		100		100		100		100	
适用轨道/型号 Can Be Used For DIN Rail	SP310系列		SP316系列		SP335系列		SP335系列		SP335系列	
标记Marker 可提供印字服务Printing Service	订货号Order NO. *		订货号Order NO. *		订货号Order NO. *		订货号Order NO. *		订货号Order NO. *	

UK系列跨接桥 UK Jumper



	开关桥接件 Contact bridge	固定边插式-跨接件 Fixed side insert - jumper
	技术参数Technical Parameter	
尺寸Size	厚度Thickness 1.2 宽度Width 14.5 高度Height 20	厚度Thickness 1 宽度Width 79.7 高度Height 10.2
其余参数Other Parameters	绝缘材料/阻燃等级, 符合UL94 Insulating Material / Flame Retardant Grade, Conforming To UL94	
	V0	
	订货信息Order Information	
位数Poles No.	订货号Order NO.	订货号Order NO.
2	306322	306320
3		
.....		
9		
10		
包装数量Package quantity	100	100
适用轨道/型号 Can Be Used For DIN Rail	订货号Order NO. SUK6-T;306911	订货号Order NO. SUK6-T;306911
标记Marker	订货号Order NO.	订货号Order NO.
可提供印字服务Printing Service	*	*

TB系列跨接桥 TB Jumper



	240 跨接桥 240 Adjacent Jumper	241 跨接桥 241 Adjacent Jumper	242 跨接桥 242 Adjacent Jumper
	技术参数Technical Parameter		
尺寸Size	厚度Thickness 3.3 宽度Width 12.15 高度Height 8	厚度Thickness 3.3 宽度Width 13.1 高度Height 10	厚度Thickness 3.6 宽度Width 15 高度Height 11.8
其余参数Other Parameters	绝缘材料/阻燃等级, 符合UL94 Insulating Material / Flame Retardant Grade, Conforming To UL94		
	V0		
	订货信息Order Information		
位数Poles No.	订货号Order NO.	订货号Order NO.	订货号Order NO.
2	240601	241601	242601
包装数量Package quantity			
适用轨道/型号 Can Be Used For DIN Rail	订货号Order NO. SP240系列	订货号Order NO. SP241系列	订货号Order NO. SP242系列
标记Marker	订货号Order NO.	订货号Order NO.	订货号Order NO.
可提供印字服务Printing Service	*	*	*

导轨防护盖 Rails lid



	7.5*35导轨终端保护套 7.5*35 Rails lid
	技术参数Technical Parameter
尺寸Size 注: 安装NS35/7.5导轨后的高度 Note: Height With DIN Rail NS 35/7.5	厚度Thickness 3.7 宽度Width 38 高度Height 7
其余参数Other Parameters	绝缘材料/阻燃等级, 符合UL94 Insulating Material / Flame Retardant Grade, Conforming To UL94
	V0
	订货信息Order Information
适配NS 35/7.5导轨 Can Be Used For DIN Rail NS 35/7.5	颜色Colour 黑Black
包装数量Package quantity	订货号Order NO. 920001
	100
适用轨道/型号 Can Be Used For DIN Rail	订货号Order NO. 900421/011 900421/031 900401/001 900421/021
标记Marker	订货号Order NO.
可提供印字服务Printing Service	*

导轨 Rails



	钢轨-7.5*35(5.2X15X10) Steel-7.5*35(5.2X15X10)	钢轨-7.5*35(5.2X25X11) Steel-7.5*35(5.2X25X11)	钢轨-7.5*35(无孔) Steel-7.5*35(No punch)
	技术参数Technical Parameter		
尺寸Size 注: 安装NS35/7.5导轨后的高度 Note: Height With DIN Rail NS 35/7.5	厚度Thickness 1 宽度Width 35 高度Height 7.5	厚度Thickness 1 宽度Width 35 高度Height 7.5	厚度Thickness 1 宽度Width 35 高度Height 7.5
其余参数Other Parameters	适配NS 35/7.5导轨 Can Be Used For DIN Rail NS 35/7.5		
	灰Gray		
包装数量Package quantity	订货号Order NO. 900421/011	订货号Order NO. 900421/031	订货号Order NO. 900401/001
适用轨道/型号 Can Be Used For DIN Rail	订货号Order NO.	订货号Order NO.	订货号Order NO.
	适用于SP35尺寸产品	适用于SP35尺寸产品	适用于SP35尺寸产品
标记Marker	订货号Order NO.	订货号Order NO.	订货号Order NO.
可提供印字服务Printing Service	*	*	*

导轨 Rails



铝轨-7.5*35(4.8X25X10.5)
Aluminum-7.5*35(4.8X25X10.5)

小导轨(钢轨)-5.5*15(4.2*12.2)
Steel-5.5*15(2.2X12.2)

技术参数Technical Parameter

技术参数Technical Parameter

尺寸Size 注: 安装NS35/7.5导轨后的高度
Note: Height With DIN Rail NS 35/7.5

厚度Thickness	宽度Width	高度Height
1	35	7.5

厚度Thickness	宽度Width	高度Height
1	15	5.5

订货信息Order Information

订货信息Order Information

适配NS 35/7.5导轨
Can Be Used For DIN Rail NS 35/7.5

颜色Colour
灰Gray

订货号Order NO.
900431/001

订货号Order NO.
900421/061

包装数量Package quantity

订货号Order NO.

订货号Order NO.

适用轨道/型号
Can Be Used For DIN Rail

适用于SP35尺寸产品

适用于SP15尺寸产品

标记Marker
可提供印字服务Printing Service

订货号Order NO.
*

订货号Order NO.
*



一字螺丝刀 screwdriver
(刀口 edge: 2.5x0.4mm)

一字螺丝刀 screwdriver
(刀口 edge: 3.5x0.5mm)

一字螺丝刀 screwdriver
(刀口 edge: 5.5x0.8mm)

订货信息Order Information

订货信息Order Information

订货信息Order Information

订货号Order NO.
910024

订货号Order NO.
910025

订货号Order NO.
910026

包装数量Package quantity

订货号Order NO.

订货号Order NO.

订货号Order NO.

适用轨道/型号
Can Be Used For DIN Rail

适用于1.5平方端子
1.5mm² Terminal block

适用于2.5,4平方端子
2.5/4mm² Terminal block

适用于6,10,16平方端子
6/10/16mm² Terminal block

标记Marker
可提供印字服务Printing Service

订货号Order NO.
*

订货号Order NO.
*

订货号Order NO.
*

弹簧接线端子专用工具 Special tools for spring terminal blocks



1A型单脚插棒-5.0mm
1A type 1 way connect bar-5.0mm

2A型双脚插棒-5.0mm
2A type 2 way connect bar-5.0mm

10A型十脚插棒-5.0mm
10 way connect bar-5.0mm

订货信息Order Information

订货信息Order Information

订货信息Order Information

订货号Order NO.
910111

订货号Order NO.
910112

订货号Order NO.
910120

包装数量Package quantity

订货号Order NO.

订货号Order NO.

订货号Order NO.

适用轨道/型号
Can Be Used For DIN Rail

SP240系列

SP240系列

SP240系列

标记Marker
可提供印字服务Printing Service

订货号Order NO.
*

订货号Order NO.
*

订货号Order NO.
*

标记牌 Marker card

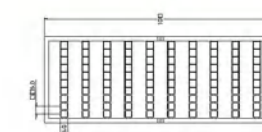

214801

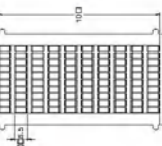

TMB3.5-100

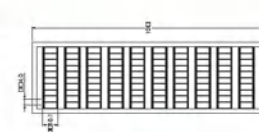

215801

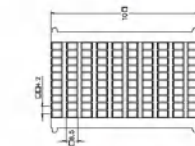

TMB4.2-100

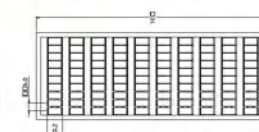

225801

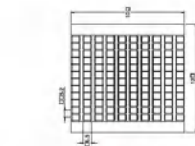

TMB5.2-120

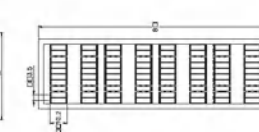

2150-801

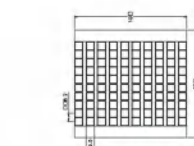

TMB6.2-100

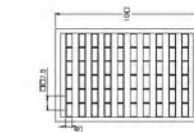

620-801

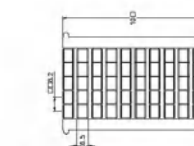

TMB8.2-50

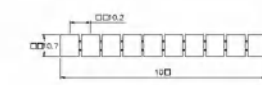

TMB10.2-10

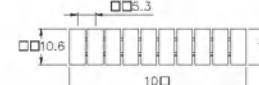

305801

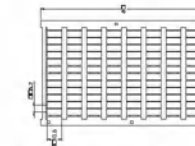

TMC5.2-96

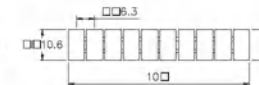

306801

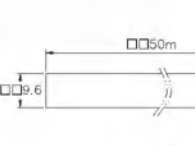

TMZ9.6-50

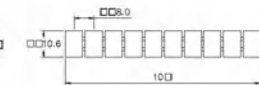

308801

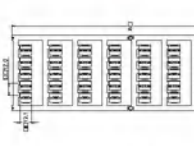

SP-WMC0.75

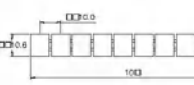

310801

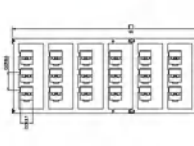

SP-WMC2.5

	技术参数Technical Parameter			技术参数Technical Parameter			技术参数Technical Parameter			技术参数Technical Parameter		
尺寸Size	间距 Pitch	长度 Length	每张卡片上数量 (行x列) Number	间距 Pitch	长度 Length	每张卡片上数量 (行x列) Number	间距 Pitch	长度 Length	每张卡片上数量 (行x列) Number	间距 Pitch	长度 Length	每张卡片上数量 (行x列) Number
	5.0	5.0	10X10=100	4.0	10.1	10X10=100	5.0	10.2	10X10=100	3.5	10.2	10X8=80
其余参数Other Parameters	绝缘材料/阻燃等级, 符合UL94 Insulating Material / Flame Retardant Grade, Conforming to UL94			V0			V0			V0		
	订货信息Order Information			订货信息Order Information			订货信息Order Information			订货信息Order Information		
颜色Colour	订货号Order NO.			订货号Order NO.			订货号Order NO.			订货号Order NO.		
白White	254801			215801			225801			2150-801		
包装数量Package quantity	5			5			5			5		

	技术参数Technical Parameter			技术参数Technical Parameter			技术参数Technical Parameter			技术参数Technical Parameter		
尺寸Size	间距 Pitch	长度 Length	每张卡片上数量 (行x列) Number	间距 Pitch	长度 Length	每张卡片上数量 (行x列) Number	间距 Pitch	长度 Length	每张卡片上数量 (行x列) Number	间距 Pitch	长度 Length	每张卡片上数量 (行x列) Number
	7.5	3.6	6X10=60	3.5	6.5	10X10=100	4.2	6.5	10X10=100	5.2	6.5	12X10=120
其余参数Other Parameters	绝缘材料/阻燃等级, 符合UL94 Insulating Material / Flame Retardant Grade, Conforming to UL94			V0			V0			V0		
	订货信息Order Information			订货信息Order Information			订货信息Order Information			订货信息Order Information		
颜色Colour	订货号Order NO.			订货号Order NO.			订货号Order NO.			订货号Order NO.		
白White	620-801			TMB3.5-100			TMB4.2-100			TMB5.2-120		
包装数量Package quantity	5			5			5			5		

	技术参数Technical Parameter			技术参数Technical Parameter			技术参数Technical Parameter			技术参数Technical Parameter		
尺寸Size	间距 Pitch	长度 Length	每张卡片上数量 (行x列) Number	间距 Pitch	长度 Length	每张卡片上数量 (行x列) Number	间距 Pitch	长度 Length	每张卡片上数量 (行x列) Number	间距 Pitch	长度 Length	每张卡片上数量 (行x列) Number
	6.2	6.5	10X10=100	8.2	6.5	5X10=50	10.2	10.7	10X1=10	5.3	10.6	10X1=10
其余参数Other Parameters	绝缘材料/阻燃等级, 符合UL94 Insulating Material / Flame Retardant Grade, Conforming to UL94			V0			V0			V0		
	订货信息Order Information			订货信息Order Information			订货信息Order Information			订货信息Order Information		
颜色Colour	订货号Order NO.			订货号Order NO.			订货号Order NO.			订货号Order NO.		
白White	TMB6.2-100			TMB8.2-50			TMB10.2-10			305801		
包装数量Package quantity	5			5			5			5		

	技术参数Technical Parameter			技术参数Technical Parameter			技术参数Technical Parameter			技术参数Technical Parameter		
尺寸Size	间距 Pitch	长度 Length	每张卡片上数量 (行x列) Number	间距 Pitch	长度 Length	每张卡片上数量 (行x列) Number	间距 Pitch	长度 Length	每张卡片上数量 (行x列) Number	间距 Pitch	长度 Length	每张卡片上数量 (行x列) Number
	6.3	10.6	10X1=10	8.0	10.6	10X1=10	10.0	10.6	10X1=10	5.2	6.5	12X8=96
其余参数Other Parameters	绝缘材料/阻燃等级, 符合UL94 Insulating Material / Flame Retardant Grade, Conforming to UL94			V0			V0			V0		
	订货信息Order Information			订货信息Order Information			订货信息Order Information			订货信息Order Information		
颜色Colour	订货号Order NO.			订货号Order NO.			订货号Order NO.			订货号Order NO.		
白White	306801			308801			310801			TMBW5.2-96		
包装数量Package quantity	5			5			5			5		

	技术参数Technical Parameter			技术参数Technical Parameter			技术参数Technical Parameter			技术参数Technical Parameter		
尺寸Size	间距 Pitch	长度 Length	每张卡片上数量 (行x列) Number	间距 Pitch	长度 Length	每张卡片上数量 (行x列) Number	间距 Pitch	长度 Length	每张卡片上数量 (行x列) Number	间距 Pitch	长度 Length	每张卡片上数量 (行x列) Number
	5.2	1.5	12X8=96	/	9.6	/	12.0	12.1	5X8=40	18	12.1	3X8=24
其余参数Other Parameters	绝缘材料/阻燃等级, 符合UL94 Insulating Material / Flame Retardant Grade, Conforming to UL94			V0			V0			V0		
	订货信息Order Information			订货信息Order Information			订货信息Order Information			订货信息Order Information		
颜色Colour	订货号Order NO.			订货号Order NO.			订货号Order NO.			订货号Order NO.		
白White	TMC5.2-96			TMZ9.6-50			SP-WMC0.75			SP-WMC2.5		
包装数量Package quantity	5			1			1			1		

