

**Miniature Relay PT**

- 2 pole 12A, 3 pole 10A or 4 pole 6A, 2, 3 or 4 form C (CO) contacts
- DC or AC coil
- Switching performance up to 3000VA
- Relay height 29mm
- Mechanical indicator, optional LED and protection diode
- Manual test tab, optionally lockable
- White marking tabs



F0191-B



Typical applications  
Universal use in control and automation

**Approvals**

VDE REG.-Nr. 115719, cULus E214025, Lloyds 00/20059(E2)  
Technical data of approved types on request

Contact Data	PT2	PT3	PT5
Contact arrangement	2 form C 2 CO	3 form C 3 CO	4 form C 4 CO
Rated voltage		240VAC	
Max. switching voltage	400VAC	400VAC	240VAC
Rated current	12A	10A	6A
Limiting making current, max. 20ms	24A	20A	12A
Limiting breaking current	12A	10A	6A
Limiting short-time current		300A/30ms	
Switching power	3000VA	2500VA	1500VA
Contact material	AgNi90/10, AgNi90/10 gold plated		
Min. recommended contact load	12V at 10mA gold plated: 20mV at 1mA 30mV at 100mA/6VDC		
Initial voltage drop			
Frequency of operation with/without load	360/36000h <sup>-1</sup>		
Operate time typ., DC coil	15ms		
Release time typ., DC coil, without/with PD	10/18ms		
Bounce time typ., DC coil, form A/form B	6/8ms		

**Contact ratings**

Type	Contact	Load	Cycles
<b>IEC 61810</b>			
PT 2 DC/AC coil	C (CO)	12A, 250VAC, cosφ=1, 70°C	70x10 <sup>3</sup>
PT 2 DC/AC coil	A (NO) of C (CO)	9A, 250VAC, cosφ=1, 80°C	150x10 <sup>3</sup>
PT 2 DC/AC coil	A (NO) of C (CO)	4A, 250VAC, cosφ=1, 80°C	300x10 <sup>3</sup>
PT 3 DC/AC coil	C (CO)	10A, 250VAC, cosφ=1, 70°C	100x10 <sup>3</sup>
PT 5 DC/AC coil	C (CO)	6A, 250VAC, cosφ=1, 70°C	100x10 <sup>3</sup>

**Contact Data (continued)**

**Contact ratings**

Type	Contact	Load	Cycles
<b>UL 508</b>			
PT 2	C (CO)	12A, 250VAC, general purpose, 70°C	6.000
PT 2	C (CO)	12A, 250VAC, resistive, 70°C	100x10 <sup>3</sup>
PT 2	A (NO) of C (CO)	12A, 250VAC, resistive, 70°C	100x10 <sup>3</sup>
PT 2	A (NO) of C (CO)	12A, 250VAC, resistive, 70°C	100x10 <sup>3</sup>
PT 3	C (CO)	10A, 250VAC, general purpose, 70°C	6.000
PT 3	C (CO)	10A, 250VAC, resistive, 70°C	100x10 <sup>3</sup>
PT 3	A (NO) of C (CO)	10A, 250VAC, resistive, 70°C	100x10 <sup>3</sup>
PT 3	B (NC) of C (CO)	10A, 250VAC, resistive, 70°C	100x10 <sup>3</sup>
PT 5	C (CO)	6A, 250VAC, general purpose, 70°C	6.000
PT 5	C (CO)	6A, 250VAC, resistive, 70°C	100x10 <sup>3</sup>
PT 5	A (NO) of C (CO)	6A, 250VAC, resistive, 70°C	100x10 <sup>3</sup>
PT 5	B (NC) of C (CO)	6A, 250VAC, resistive, 70°C	100x10 <sup>3</sup>

**EN60947-4-1**

PT 2	A (NO) of C (CO)	400VAC, 3.75A, AC3, opposite polarity, 70°C
PT 2	A (NO) of C (CO)	230VAC, 1.7A, AC5b (400W lamp load), opposite polarity, 70°C
PT 3	A (NO) of C (CO)	250VAC, 2A, AC3, opposite polarity 70°C
PT 3	A (NO) of C (CO)	230VAC, 1.7A, AC5b (400W lamp load), opposite polarity, 70°C
PT 5	A (NO) of C (CO)	250VAC, 3A, AC3, same polarity 70°C
PT 5	A (NO) of C (CO)	230VAC, 1.7A, AC5b (400W lamp load), same polarity, 70°C

Mechanical endurance	
DC coil	30x10 <sup>6</sup> operations
AC coil	20x10 <sup>6</sup> operations

**Coil Data**

Coil voltage range	6 to 220VDC 6 to 230VAC
Operative range, IEC 61810	2
DC coil, AC-coil 50Hz	
AC coil 60 Hz at 70°C	90..110% of rated voltage
Coil insulation system according UL	class 155 (F)

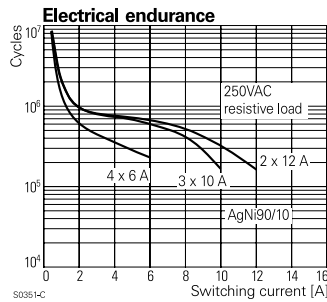
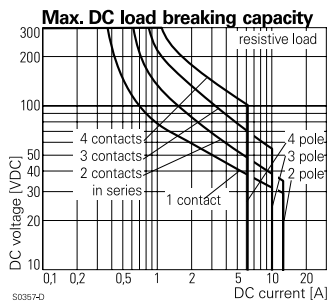

**Miniature Relay PT (Continued)**

**Coil Data (continued)**

**Coil versions, DC coil, standard**

Coil code	Rated voltage VDC	Operate voltage VDC	Release voltage VDC	Coil resistance $\Omega \pm 10\%$ <sup>1)2)</sup>	Rated coil power mW
006	6	4.5	0.6	48	750
012	12	9.0	1.2	192	750
024	24	18.0	2.4	777	741
048	48	36.0	4.8	3072	750
060	60	45.0	6	4845 <sup>1)</sup>	743
110	110	82.5	11	16133 <sup>2)</sup>	750
220	220	165.0	22	64533 <sup>2)</sup>	750

**Coil versions, DC coil with bipolar LED or LED and protection diode**

Coil code	Rated bipol. LED LED PD <sup>3)</sup>	Rated voltage VDC	Operate voltage VDC	Release voltage VDC	Coil resistance $\Omega \pm 10\%$ <sup>1)2)</sup>	Rated coil +LED pwr. mW
L06	LA6	6	4.5	0.6	48	750+3.5
L12	LB2	12	9.0	1.2	192	750+10
L24	LC4	24	18.0	2.4	777	741+18
L48	LE8	48	36.0	4.8	3072	750+38
L60	LG0	60	45.0	6.0	4845 <sup>1)</sup>	743+56
M10	MB0	110	82.5	11.0	16133 <sup>2)</sup>	750+96.5
N20	NC0	220	165.0	22.0	64533 <sup>2)</sup>	750+202.5

1) Coil resistance  $\pm 12\%$ , 2) Coil resistance  $\pm 15\%$ ,

3) Protection diode PD; standard polarity: +A1/-A2

All figures are given for coil without pre-energization, at ambient temperature +23°C

**Coil versions, AC coil, 50/60Hz**

Coil code	Rated STD LED	Rated voltage VAC	Operate voltage 50/60Hz VAC	Release voltage 50/60Hz VAC	Coil resistance $\Omega \pm 10\%$ <sup>1)2)</sup>	Rated coil power 50/60Hz VA
506	R06	6	4.8/5.4	1.8	11	1.0/0.85
512	R12	12	9.6/10.8	3.6	48	1.0/0.85
524	R24	24	19.2/21.6	7.2	192	1.0/0.79
548	R48	48	38.4/43.2	14.4	777	1.0/0.87
560	R60	60	48.0/54.0	18.0	1306	1.0/0.87
615	S15	115	92.0/103.5	34.5	4845 <sup>1)</sup>	1.0/0.86
730	T30	230	184/207	69.0	19465 <sup>2)</sup>	1.0/0.90

1) Coil resistance  $\pm 12\%$ , 2) Coil resistance  $\pm 15\%$

All figures are given for coil without pre-energization, at ambient temperature +23°C

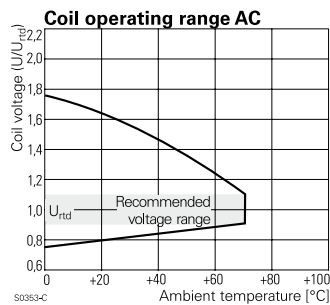
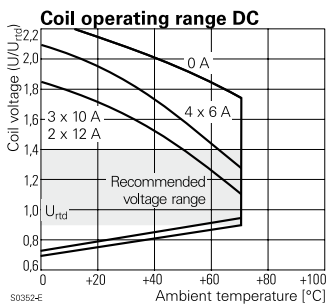

Insulation Data	PT2	PT3	PT5
Initial dielectric strength			
between open contacts	1200V <sub>rms</sub>	1200V <sub>rms</sub>	1200V <sub>rms</sub>
between contact and coil	2500V <sub>rms</sub>	2500V <sub>rms</sub>	2500V <sub>rms</sub>
between adjacent contacts	2500V <sub>rms</sub>	2500V <sub>rms</sub>	2000V <sub>rms</sub>
Initial surge withstand voltage			
between contact and coil	5000V (1.2/50μs)		
Clearance/creepage			
between contact and coil	≥4/4mm	≥4/4mm	≥4/4mm
between adjacent contacts	≥3.5/9.5mm	≥2.6/3.5mm	≥1.8/3.5mm
Material group of insulation parts	IIIa		

**Other Data**

Material compliance: EU RoHS/ELV, China RoHS, REACH, Halogen content refer to the Product Compliance Support Center at [www.tycoelectronics.com/customer-support/rohssupportcenter](http://www.tycoelectronics.com/customer-support/rohssupportcenter)

Ambient temperature	-40 to +70°C
Cold storage, IEC 60068-2-1	-40°C/16h
Dry heat, IEC 60068-2-2	85°C/16h
Category of environmental protection IEC 61810	RTII - flux proof
Vibration resistance (functional), form A (NO)/form B (NC)	7/4g
Shock resistance (functional), form A (NO)/form B (NC)	20/5g
Terminal type	PCB-THT, plug-in quick-connect
Cover retention, pull/push force	100/100N
Weight	30g
Mounting distance, for mounting on PCB	5mm
Resistance to soldering heat THT IEC 60068-2-20	270°C/10s
Packaging unit	10/250pcs.

**Accessories**

For details see datasheet [Accessories Miniature Relay PT](#)  
Note: indicated contact ratings and electrical endurance data for direct wiring of relays (according IEC 61810-1); for relays mounted on sockets deratings may apply.

**Product Sets**

Complete sets consisting of a relay mounted on a socket see [Package PT](#)

**Miniature Relay PT (Continued)**

**PCB layout / terminal assignment**

Bottom view on pins

4 pole

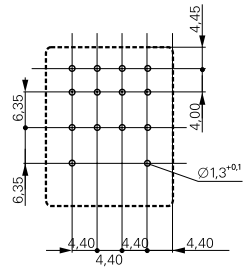

S0354-AA

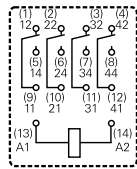

S0354-AD

3 pole

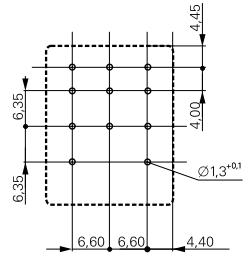

S0354-AB

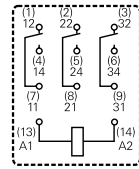

S0354-AE

2 pole

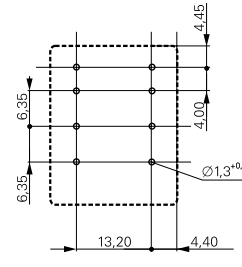

S0354-AC

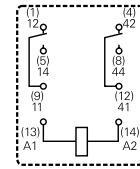

S0354-AF

**Circuit**

LED

protection diode+LED

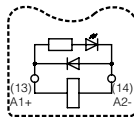
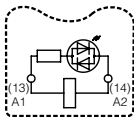

**Dimensions**

Solder- and plug-in terminals (standard version)

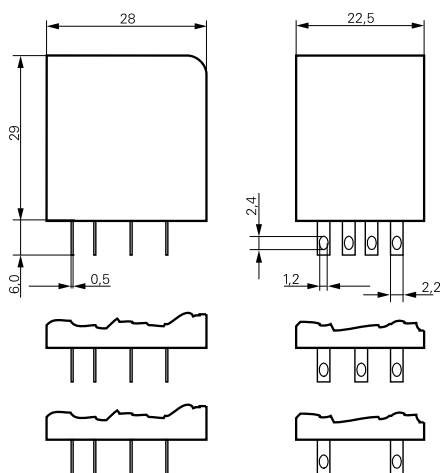

S0355-AA

PCB version

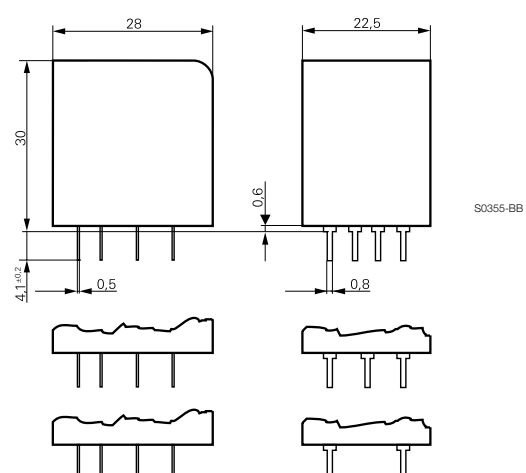

S0355-BB

**Miniature Relay PT** (Continued)

**Product code structure**

Typical product code **PT 5 7 0 730**

<b>Type</b>	PT Miniature Relay PT				
<b>Contact arrangement</b>	<b>2</b> 2 form C contacts (2 CO contacts) <b>3</b> 3 form C contacts (3 CO contacts) <b>5</b> 4 form C contacts (4 CO contacts)				
<b>Contact material</b>	<b>7</b> AgNi 90/10, with test button <b>8</b> AgNi 90/10 gold plated, with test button <b>2</b> AgNi 90/10, without test button <b>3</b> AgNi 90/10 gold plated, without test button				
<b>Version</b>	<b>0</b> Standard, 2.8mm quick connect term. <b>1</b> PCB terminals				
<b>Coil</b>	Coil code: please refer to coil versions table				

Other types on request

Product code	Cont. Config.	Cont. material	Version	Coil	Coil	Part number			
PT270024	2 form C 2 CO contacts	AgNi 90/10 test button	AMP 2.8 connectors	DC coil	24VDC	4-1419111-2			
PT270524				AC coil	24VAC	4-1419111-8			
PT270615					115VAC	5-1419111-0			
PT270730					230VAC	5-1419111-1			
PT270L24					DC coil+LED	24VDC	9-1415001-1		
PT270R24					AC coil+LED	24VAC	1415002-1		
PT270S15						115VAC	2-1415039-1		
PT270T30						230VAC	3-1415002-1		
PT271024						PCB terminals	DC coil	24VDC	5-1419111-3
PT271524							AC coil	24VAC	5-1419111-6
PT271615								115VAC	4-1419135-0
PT271730								230VAC	5-1419111-8
PT370024				3 form C 3 CO contacts	AgNi 90/10 test button	AMP 2.8 connectors	DC coil	24VDC	6-1419111-1
PT370524							AC coil	24VAC	6-1419111-6
PT370615		115VAC	6-1419111-8						
PT370730		230VAC	6-1419111-9						
PT370L24		DC coil+LED	24VDC				5-1415002-1		
PT370R24		AC coil+LED	24VAC				7-1415002-1		
PT370S15			115VAC				9-1415039-1		
PT370T30			230VAC				9-1415002-1		
PT371024			PCB terminals				DC coil	24VDC	7-1419111-1
PT371524							AC coil	24VAC	7-1419111-3
PT371615								115VAC	1393154-8
PT371730								230VAC	7-1419111-5
PT570024	4 form C 4 CO contacts	AgNi 90/10 test button	AMP 2.8 connectors				DC coil	24VDC	1-1393154-2
PT570524							AC coil	24VAC	8-1419111-7
PT570615					115VAC	9-1419111-0			
PT570730					230VAC	9-1419111-1			
PT570L24					DC coil+LED	24VDC	6-1415001-1		
PT570LC4					DC coil+LED+PD		7-1415541-0		
PT570R24					AC coil+LED	24VAC	7-1415001-1		
PT570S15						115VAC	7-1415003-1		
PT570T30						230VAC	8-1415001-1		
PT571024						PCB terminals	DC coil	24VDC	9-1419111-3
PT571524							AC coil	24VAC	9-1419111-6
PT571615								115VAC	1-1393154-5
PT571730								230VAC	9-1419111-8
PT580024					AgNi 90/10 gold plated test button	AMP 2.8 connectors	DC coil	24VDC	1-1393154-7
PT580524		AC coil	24VAC	2-1393154-1					
PT580730			230VAC	2-1393154-2					
PT580L24		DC coil+LED	24VDC	5-1415026-1					
PT580R24		AC coil+LED	24VAC	6-1415026-1					
PT580T30			230VAC	7-1415026-1					
PT581024			PCB terminals	DC coil			24VDC	7-1419135-2	
PT581730				AC coil			230VAC	2-1393154-3	