

[INSTALLATION CONNECTORS]

> Installation connectors are the most popular mini connectors, widely used in construction, communication, decoration and electricity. The connectors realizes the connection without any tools help.

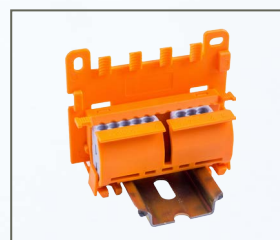

Mounting Carrier for FJ100 Series



Mounting Carrier for FJ400 Series



FJ-102

CERTIFICATION	TUV/CE/RoHS	
MATERIAL		
Size(mm)	19.5x9.5x13.1	
Clamping Spring	Stainless Steel	
Conductor	Tin-Coated Copper	
Cover	Yellow, PA66/V-0	
Housing	PC	
ELECTRICAL DATA		
Impulse Voltage(kV)	4	
Standards	IEC 60947-7-1	UL 1059
Voltage(V)	400	300
Current(A)	24	20
WIRING DATA		
Strip Length(mm)	12	
Stranded(mm ² /AWG)	1.5~2.5	16~12
Solid(mm ² /AWG)	0.75~2.5	18~12
Connection Points	2	
PACKING	Bag	Box
Pcs/Inner Bag&Box	200	100
Pcs/Master Carton	10000	5000

ACCESSORIES

Mounting Carrier		
	Model	AB/100
	Size(mm)	61x18x30
	Pcs/Bag	20



FJ-104

CERTIFICATION	TUV/CE/RoHS	
MATERIAL		
Size(mm)	19.5x15x13.1	
Clamping Spring	Stainless Steel	
Conductor	Tin-Coated Copper	
Cover	Orange, PA66/V-0	
Housing	PC	
ELECTRICAL DATA		
Impulse Voltage(kV)	4	
Standards	IEC 60947-7-1	UL 1059
Voltage(V)	400	300
Current(A)	24	20
WIRING DATA		
Strip Length(mm)	12	
Stranded(mm ² /AWG)	1.5~2.5	16~12
Solid(mm ² /AWG)	0.75~2.5	18~12
Connection Points	4	
PACKING	Bag	Box
Pcs/Inner Bag&Box	200	100
Pcs/Master Carton	6400	5000

ACCESSORIES

Mounting Carrier		
	Model	AB/100
	Size(mm)	61x18x30
	Pcs/Bag	20



FJ-106

CERTIFICATION	TUV/CE/RoHS	
MATERIAL		
Size(mm)	19.5x18.8x13.1	
Clamping Spring	Stainless Steel	
Conductor	Tin-Coated Copper	
Cover	Purple, PA66/V-0	
Housing	PC	
ELECTRICAL DATA		
Impulse Voltage(kV)	4	
Standards	IEC 60947-7-1	UL 1059
Voltage(V)	400	300
Current(A)	24	20
WIRING DATA		
Strip Length(mm)	12	
Stranded(mm ² /AWG)	1.5~2.5	16~12
Solid(mm ² /AWG)	0.75~2.5	18~12
Connection Points	6	
PACKING	Bag	Box
Pcs/Inner Bag&Box	200	50
Pcs/Master Carton	4800	2500

ACCESSORIES

Mounting Carrier		
	Model	AB/100
	Size(mm)	61x18x30
	Pcs/Bag	20



FJ-108

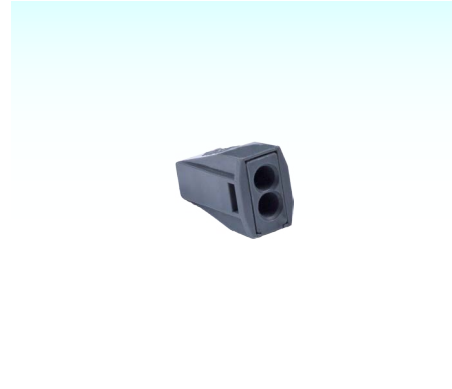

FJ-112



FJ-114

CERTIFICATION	TUV/CE/RoHS	
MATERIAL		
Size(mm)	19.5x24x13.1	
Clamping Spring	Stainless Steel	
Conductor	Tin-Coated Copper	
Cover	Gray, PA66/V-0	
Housing	PC	
ELECTRICAL DATA		
Impulse Voltage(kV)	4	
Standards	IEC 60947-7-1	UL 1059
Voltage(V)	400	300
Current(A)	24	20
WIRING DATA		
Strip Length(mm)	12	
Stranded(mm ² /AWG)	1.5~2.5	16~12
Solid(mm ² /AWG)	0.75~2.5	18~12
Connection Points	8	
PACKING	Bag	Box
Pcs/Inner Bag&Box	200	50
Pcs/Master Carton	4000	2500

ACCESSORIES

Mounting Carrier	Model	Size(mm)	Pcs/Bag
	AB/100	61x18x30	20

CERTIFICATION	CE/RoHS	
MATERIAL		
Size(mm)	19.5x9.5x13.1	
Clamping Spring	Stainless Steel	
Conductor	Tin-Coated Copper	
Cover	PA66/V-0	
Housing	PA66/V-0	
ELECTRICAL DATA		
Impulse Voltage(kV)	4	
Standards	IEC 60947-7-1	UL 1059
Voltage(V)	400	300
Current(A)	24	20
WIRING DATA		
Strip Length(mm)	12	
Stranded(mm ² /AWG)	1.5~2.5	16~12
Solid(mm ² /AWG)	0.75~2.5	18~12
Connection Points	2	
PACKING	Bag	Box
Pcs/Inner Bag&Box	200	100
Pcs/Master Carton	10000	5000

ACCESSORIES

Mounting Carrier	Model	Size(mm)	Pcs/Bag
	AB/100	61x18x30	20

CERTIFICATION	CE/RoHS	
MATERIAL		
Size(mm)	19.5x15x13.1	
Clamping Spring	Stainless Steel	
Conductor	Tin-Coated Copper	
Cover	PA66/V-0	
Housing	PA66/V-0	
ELECTRICAL DATA		
Impulse Voltage(kV)	4	
Standards	IEC 60947-7-1	UL 1059
Voltage(V)	400	300
Current(A)	24	20
WIRING DATA		
Strip Length(mm)	12	
Stranded(mm ² /AWG)	1.5~2.5	16~12
Solid(mm ² /AWG)	0.75~2.5	18~12
Connection Points	4	
PACKING	Bag	Box
Pcs/Inner Bag&Box	200	100
Pcs/Master Carton	6400	5000

ACCESSORIES

Mounting Carrier	Model	Size(mm)	Pcs/Bag
	AB/100	61x18x30	20



FJ-116



FJ-118

CERTIFICATION	CE/RoHS	
MATERIAL		
Size(mm)	19.5x18.8x13.1	
Clamping Spring	Stainless Steel	
Conductor	Tin-Coated Copper	
Cover	PA66/V-0	
Housing	PA66/V-0	
ELECTRICAL DATA		
Impulse Voltage(kV)	4	
Standards	IEC 60947-7-1	UL 1059
Voltage(V)	400	300
Current(A)	24	20
WIRING DATA		
Strip Length(mm)	12	
Stranded(mm ² /AWG)	1.5~2.5	16~12
Solid(mm ² /AWG)	0.75~2.5	18~12
Connection Points	6	
PACKING	Bag	Box
Pcs/Inner Bag&Box	200	50
Pcs/Master Carton	4800	2500

ACCESSORIES

Mounting Carrier	Model	Size(mm)	Pcs/Bag
	AB/100	61x18x30	20

CERTIFICATION	CE/RoHS	
MATERIAL		
Size(mm)	19.5x24x13.1	
Clamping Spring	Stainless Steel	
Conductor	Tin-Coated Copper	
Cover	PA66/V-0	
Housing	PA66/V-0	
ELECTRICAL DATA		
Impulse Voltage(kV)	4	
Standards	IEC 60947-7-1	UL 1059
Voltage(V)	400	300
Current(A)	24	20
WIRING DATA		
Strip Length(mm)	12	
Stranded(mm ² /AWG)	1.5~2.5	16~12
Solid(mm ² /AWG)	0.75~2.5	18~12
Connection Points	8	
PACKING	Bag	Box
Pcs/Inner Bag&Box	200	50
Pcs/Master Carton	4000	2500

ACCESSORIES

Mounting Carrier	Model	Size(mm)	Pcs/Bag
	AB/100	61x18x30	20



FJ-402



FJ-403



FJ-405

CERTIFICATION	TUV/CQC/CE/RoHS	
MATERIAL		
Size(mm)	20.5x12.4x14.5	
Clamping Spring	Stainless Steel	
Conductor	Tin-Coated Copper	
Lever	Orange, PA66/V-0	
Housing	PA66/V-0	
ELECTRICAL DATA		
Impulse Voltage(kV)	4	
Standards	IEC 60947-7-1	UL 1059
Voltage(V)	600	600
Current(A)	32	20
WIRING DATA		
Strip Length(mm)	9~10	
Flexible(mm ² /AWG)	0.08~2.5	28~14
Rigid(mm ² /AWG)	0.08~4	28~12
Connection Points	2	
PACKING	Bag	Box
Pcs/Inner Bag&Box	200	80
Pcs/Master Carton	6000	4000

ACCESSORIES

Mounting Carrier	Model	Size(mm)	Pcs/Bag
	AB/400	60.5x20x32	20

Strain Relief Plate	Model	Size(mm)	Pcs/Bag
	AB/401	67x52x1.5	100

CERTIFICATION	TUV/CQC/CE/RoHS	
MATERIAL		
Size(mm)	20.5x17x14.5	
Clamping Spring	Stainless Steel	
Conductor	Tin-Coated Copper	
Lever	Orange, PA66/V-0	
Housing	PA66/V-0	
ELECTRICAL DATA		
Impulse Voltage(kV)	4	
Standards	IEC 60947-7-1	UL 1059
Voltage(V)	600	600
Current(A)	32	20
WIRING DATA		
Strip Length(mm)	9~10	
Flexible(mm ² /AWG)	0.08~2.5	28~14
Rigid(mm ² /AWG)	0.08~4	28~12
Connection Points	3	
PACKING	Bag	Box
Pcs/Inner Bag&Box	200	60
Pcs/Master Carton	4000	3000

ACCESSORIES

Mounting Carrier	Model	Size(mm)	Pcs/Bag
	AB/400	60.5x20x32	20

Strain Relief Plate	Model	Size(mm)	Pcs/Bag
	AB/401	67x52x1.5	100

CERTIFICATION	TUV/CQC/CE/RoHS	
MATERIAL		
Size(mm)	20.5x26.6x14.5	
Clamping Spring	Stainless Steel	
Conductor	Tin-Coated Copper	
Lever	Orange, PA66/V-0	
Housing	PA66/V-0	
ELECTRICAL DATA		
Impulse Voltage(kV)	4	
Standards	IEC 60947-7-1	UL 1059
Voltage(V)	600	600
Current(A)	32	20
WIRING DATA		
Strip Length(mm)	9~10	
Flexible(mm ² /AWG)	0.08~2.5	28~14
Rigid(mm ² /AWG)	0.08~4	28~12
Connection Points	5	
PACKING	Bag	Box
Pcs/Inner Bag&Box	100	40
Pcs/Master Carton	2500	2000

ACCESSORIES

Mounting Carrier	Model	Size(mm)	Pcs/Bag
	AB/400	60.5x20x32	20

Strain Relief Plate	Model	Size(mm)	Pcs/Bag
	AB/401	67x52x1.5	100



FJ-402P



FJ-403P



FJ-405P

CERTIFICATION	CE/RoHS	
MATERIAL		
Size(mm)	20.5x12.4x14.5	
Clamping Spring	Stainless Steel	
Conductor	Tin-Coated Copper	
Lever	Blue, PC	
Housing	PC	
ELECTRICAL DATA		
Impulse Voltage(kV)	4	
Standards	IEC 60947-7-1	UL 1059
Voltage(V)	600	600
Current(A)	32	20
WIRING DATA		
Strip Length(mm)	9~10	
Flexible(mm ² /AWG)	0.08~2.5	28~14
Rigid(mm ² /AWG)	0.08~4	28~12
Connection Points	2	
PACKING	Bag	Box
Pcs/Inner Bag&Box	200	80
Pcs/Master Carton	6000	4000

ACCESSORIES

Mounting Carrier	Model	Size(mm)	Pcs/Bag
	AB/400	60.5x20x32	20

Strain Relief Plate	Model	Size(mm)	Pcs/Bag
	AB/401	67x52x1.5	100

CERTIFICATION	CE/RoHS	
MATERIAL		
Size(mm)	20.5x17x14.5	
Clamping Spring	Stainless Steel	
Conductor	Tin-Coated Copper	
Lever	Blue, PC	
Housing	PC	
ELECTRICAL DATA		
Impulse Voltage(kV)	4	
Standards	IEC 60947-7-1	UL 1059
Voltage(V)	600	600
Current(A)	32	20
WIRING DATA		
Strip Length(mm)	9~10	
Flexible(mm ² /AWG)	0.08~2.5	28~14
Rigid(mm ² /AWG)	0.08~4	28~12
Connection Points	3	
PACKING	Bag	Box
Pcs/Inner Bag&Box	200	60
Pcs/Master Carton	4000	3000

ACCESSORIES

Mounting Carrier	Model	Size(mm)	Pcs/Bag
	AB/400	60.5x20x32	20

Strain Relief Plate	Model	Size(mm)	Pcs/Bag
	AB/401	67x52x1.5	100

CERTIFICATION	CE/RoHS	
MATERIAL		
Size(mm)	20.5x26.6x14.5	
Clamping Spring	Stainless Steel	
Conductor	Tin-Coated Copper	
Lever	Blue, PC	
Housing	PC	
ELECTRICAL DATA		
Impulse Voltage(kV)	4	
Standards	IEC 60947-7-1	UL 1059
Voltage(V)	600	600
Current(A)	32	20
WIRING DATA		
Strip Length(mm)	9~10	
Flexible(mm ² /AWG)	0.08~2.5	28~14
Rigid(mm ² /AWG)	0.08~4	28~12
Connection Points	5	
PACKING	Bag	Box
Pcs/Inner Bag&Box	100	40
Pcs/Master Carton	2500	2000

ACCESSORIES

Mounting Carrier	Model	Size(mm)	Pcs/Bag
	AB/400	60.5x20x32	20

Strain Relief Plate	Model	Size(mm)	Pcs/Bag
	AB/401	67x52x1.5	100